

**GeniSys™  
LD-34b  
Owner's Manual**

Copyright © 2018 Allen Organ Company LLC  
All Rights Reserved

# ALLEN ORGAN COMPANY

For more than sixty years--practically the entire history of electronic organs-- Allen Organ Company has built the finest organs that technology would allow.

In 1939, Allen built and marketed the world's first electronic oscillator organ. The tone generators for this instrument used two hundred forty-four vacuum tubes, contained about five thousand components, and weighed nearly three hundred pounds. Even with all this equipment, the specification included relatively few stops.

By 1959, Allen had replaced vacuum tubes in oscillator organs with transistors. Thousands of transistorized instruments were built, including some of the largest, most sophisticated oscillator organs ever designed.

Only a radical technological breakthrough could improve upon the performance of Allen's oscillator organs. Such a breakthrough came in conjunction with the United States Space Program in the form of highly advanced digital microcircuits. In 1971, Allen produced and sold the world's first musical instrument utilizing digitally sampled voices!

Your organ is significantly advanced since the first generation Allen digital instrument. Organs with GeniSys™ technology are the product of years of advancements in digital sound and control techniques by Allen Organ Company. This system represents the apex of digital technology applied to exacting musical tasks. The result is a musical instrument of remarkably advanced tone quality and performance.

**Congratulations** on the purchase of your new Allen Organ! You have acquired the most advanced electronic organ ever built, one that harnesses a sophisticated custom computer system to create and control beautiful organ sound. Familiarize yourself with the instrument by reading through this booklet.

# CONTENTS

I.	GENISYS™ DISPLAY.....	1
II.	ORGAN STOPS.....	1
III.	STOP CONTROLS.....	3
IV.	SPECIALIZED STOP CONTROLS.....	4
V.	PIANO AND HARP.....	5
VI.	EXPRESSION & CRESCENDO SHOES.....	6
VII.	TUTTI I and TUTTI II.....	6
VIII.	SETTING PISTONS.....	6
IX.	REVERSIBLE PISTONS.....	7
X.	ARTISTIC REGISTRATION.....	8
XI.	TRANSPOSER.....	11
XII.	ACOUSTIC PORTRAITä.....	12
XIII.	MULTIPLE VOICE SETS.....	12
XIV.	INSTALLATION, VOICING, AND CARE OF THE ORGAN.....	13
XV.	SAFETY INFORMATION.....	14
XVI.	GENISYS™ DISPLAY REFERENCE GUIDE.....	15
	A. BASIC OPERATION.....	15
	1. Start-Up Sequence.....	15
	2. Capture Memory Physics.....	16
	3. Locking Capture Memories.....	16
	4. Unlocking Memories Using Your Code.....	17
	5. Stoplist Library●.....	17
	6. Acoustic Portrait●.....	17
	7. Alternate/Global Tuning.....	18
	8. Unlocking All Capture Memories.....	19
	B. USB OPERATION.....	20
	1. USB Memory Port.....	20
	2. GeniSys™ Recorder.....	20
	3. Hymn Player.....	22
	4. Performance Player.....	23
	5. Capture Load/Save.....	23
	C. ADVANCED OPERATION.....	25
	1. Configuring General Pistons.....	25
	2. Restoring Original Factory Settings.....	26
	3. Self Check; Stop Action and Capture.....	26
	4. Sostenuito ( <i>optional – requires Sustain Kick Switch</i> ).....	26
	5. Modifying Crescendo and Tutti B Settings.....	27
	D. MIDI FUNCTIONS.....	29
	1. Standard MIDI Channel Assignments.....	29
	2. Selecting Program Change Modes.....	29
	3. MIDI Bank Selecting.....	30
	4. Assigning MIDI Program Changes to Pistons.....	31
	5. MIDI Base Channel.....	31
	6. MIDI Expression Settings.....	32
	7. MIDI Sustain Kick Switch ( <i>optional</i> ).....	33
	8. Organ Local Off.....	33
	10. Transmission/Reception of Individual Stop Data.....	33
	E. MIDI GUIDE.....	35
	1. MIDI for Organists.....	35
	2. Allen’s Exclusive MIDI System.....	36
	4. General MIDI Sound List.....	38
	APPENDIX A: MIDI IMPLEMENTATION CHART.....	39
	APPENDIX B: VISUAL KEY RANGE CHART.....	40
	APPENDIX C: LDS Hymn Player List.....	41
	APPENDIX D: GNU PUBLIC LICENSE INFORMATION.....	44

## I. GENISYS™ DISPLAY

The LD-34b contains a multi-function color touch screen display. GeniSys™ Display displays and controls a variety of features and functions which are accessed and changed just by touching the screen.

Please reference the online GeniSys™ Display LDS tutorial which can be easily accessed using a personal computer (PC or MAC), tablet or Smart Phone (Android or iPhone) at: <http://www.allenorgan.com/genisys>

 **Important!:** Only a light touch is needed to select the buttons on the GeniSys™ Display touch screen. Use only the tip or pad of your finger to touch the screen. Do NOT use any sharp objects such as fingernails, pencil/pen tip, etc. to touch the screen as this could scratch and irreparably damage the touch screen display.

## II. ORGAN STOPS

### PITCH FOOTAGE

The number appearing on each stop, along with its name, indicates the “pitch” or “register” of the particular stop. Organs can produce notes of different pitches from a single playing key. When this sound corresponds to the actual pitch of the played key, the stop is referred to as being of 8’ (eight foot) pitch; therefore, when an 8’ stop is selected and Middle C is depressed, the pitch heard is Middle C. If the sounds are an octave higher, it is called 4’ or octave pitch. If two octaves higher, it is called 2’ pitch. A stop sounding three octaves higher is at a 1’ pitch. Similarly, a 16’ stop sounds an octave lower and a 32’ stop two octaves lower.

Stops of 16’, 8’, 4’, 2’ and 1’ pitch all have octave relationships, that is, these whole numbered stops all sound at octaves of whatever key is depressed. Non-octave pitches are also used in organs. Their footage numbers contain a fraction and they are referred to as *Mutations*. Among these are the 2-2/3’ *Nasard*, 1-3/5’ *Tierce*, 1-1/3’ *Quintflöte* and 2-2/3’ *Twelfth*. Because they introduce unusual pitch relationships with respect to the 8’ tone, they are most effective when combined with other stops and used either in solo passages or in small ensembles of flutes.

### TONAL FAMILIES

#### 1. Flues

Organ tones divide into two main categories: *flues* and *reeds*. In pipe organs, flue pipes are those in which the sound is set in motion by wind striking directly on the edge of the mouth of the pipe. Flues include principal, flute and string tones. Compound stops and hybrid stops are variations within these three stop families.

The term “imitative” means that the organ stop imitates the sound of a corresponding orchestral instrument; for example, an imitative 8’ Viola stop sounds like an orchestral viola.

<u>Principal Voices:</u> Principal, Diapason, Octave, Fifteenth, Quinte	Characteristic organ tones, not imitative of any orchestral instruments. Usually present at many pitches and in all divisions. Rich, warm and harmonically well developed.
<u>Flute Voices - Open:</u> Harmonic Flute, Koppelflöte, flute mutation stops <u>Flute Voices - Stopped:</u> Holzgedackt, Bourdon, Lieblichgedackt, Rohr Bourdon	Lesser harmonic development than Principals. Open flutes are somewhat imitative; stopped flutes are not. Present at all pitch levels and in all divisions.
<u>String Voices:</u> Gamba, Salicional, Viole Celeste	Mildly imitative and brighter harmonic development than Principals. Usually appear at 8’ first; can be 4’ & 16’ ranks.
<u>Compound Voices:</u> Mixture, Fourniture	Voices produced by more than one rank sounding simultaneously. Best registered with other stops.
<u>Hybrid Voices:</u> Erzähler, Spitzflöte	Voices that combine the tonal characteristic of two families of sound, e.g., flutes and principals, or strings and principals.

## 2. Reeds

In *reed* pipes, a metal tongue vibrates against an open flattened side of a metal tube called a shallot. The characteristic sounds of different reeds are produced through resonators of different shapes. The family of reeds subdivides as follows:

<u>Chorus or Ensemble:</u> Double Trumpet, Tromba, Posaune, Clarion, Bombarde <u>Solo:</u> Hautbois, Clarinet, Krummhorn	Voices of great harmonic development; some are imitative of their orchestral counterparts.
--	--

Your Allen Organ provides authentic, digitally sampled voices. They are protected by copyrights owned by the Allen Organ Company and are stored in memory devices, each having affixed to it a copyright notice; e.g., © 2003 AOCO, © 2001 AOCO, etc., pursuant to Title 17 of the United States Code, Section 101 et seq.

### III. STOP CONTROLS

#### PEDAL ORGAN

Contre Bourdon 32'	String tone at 32' pitch. This stop is smooth and much less assertive rounding out the lower end of a string ensemble.
Diapason 16'	The 16' member of the Pedal Principal chorus. Strongest pedal flue stop.
Bourdon 16'	Stopped flute tone of weight and solidity.
Lieblich Gedackt 16' (Swell)	Softer stopped flute of delicacy and definition. Useful where a soft 16' pitch is required. <i>Note: Expresses with the Swell division.</i>
Octave 8'	8' member of the Pedal Principal chorus.
Flute 8'	Stopped flute tone of 8' pitch, useful in adding clarity to a pedal line in combination with the Bourdon 16' or Lieblich Bourdon 16'.
Choralbass 4'	Pedal 4' principal tone.
Mixture III	Compound stop of Principal tones. One pedal produces three distinct pitches at octave and fifth relationships to the pedal being pressed. Used to crown the Pedal Principal chorus.
Contre Posaune 32'	Robust reed which adds "snarl" to the Pedal division. Use with large combinations.
Posaune 16'	A strong 16' Pedal reed that lends strength and "snarl" to the Pedal line.
(Swell) Waldhorn 16'	Loud and full timbred stop similar to that of a French Horn at 16' pitch. <i>Note: Expresses with the Swell division.</i>
Clairon 4'	A bright chorus reed. Also usable as a solo voice.

#### SWELL ORGAN

Lieblich Gedackt 16'	Softer stopped flute of delicacy and definition. Useful where a soft 16' pitch is required.
Gedackt 8'	Stopped Flute tone of moderate harmonic development. Provides the 8' member of the Swell Flute chorus and is useful by itself or with other flutes and mutations in creating solo voices.
Viole 8'	Full bodied string tone.
Viola Celeste 8'	String tone, slightly detuned, used with the Viole 8' to create a warm String celeste.
Octave 4'	Bright 4' Principal tone.
Nachthorn 4'	Distinctive open flute voice of wide scale that works well in ensembles of flutes or strings, or as a solo voice.
Nasard 2-2/3'	Flute mutation that sounds one octave and a fifth above the keys played. Always used with other stops (usually beginning with 8') for coloration.
Piccolo 2'	A delicate, clear open flute at 2' pitch.
Tierce 1-3/5'	Flute mutation that sounds a seventeenth (two octaves and a third) above the keys played. Use mainly with 8' stops or flute ensembles.

Furniture IV	Compound stop, or mixture comprised of Principal tones. Each note played produces four distinct pitches at octave and fifth relationships to the key being pressed. The mixture should never be used without stops of lower pitches. The Furniture IV is typically added to Diapason or Flute ensembles, or to a reed chorus.
Waldhorn 16'	Loud and full timbred stop similar to that of a French Horn at 16' pitch. Also usable as a distinctive solo reed.
French Trumpet 8'	Chorus reed stop of rich harmonic development. Can also be used as a solo reed.
Oboe 8'	Solo reed with a pungent nasal timbre.

### **GREAT ORGAN**

Violone 16'	String tone at 16' pitch.
Diapason 8'	Foundation stop of the Great principal chorus.
Gemshorn 8'	Hybrid stop that combines tonal characteristics of the string and flute families, resulting in a light Diapason quality.
Harmonic Flute 8'	Open flute of considerable harmonic development. An excellent solo stop.
Erzähler Celeste II 8'	Two hybrid stops at 8' pitch, one slightly detuned from the other that combines the tonal characteristics of both the string and flute families.
Octave 4'	The 4' member of the Great Principal chorus.
Spitzflöte 4'	Partially stopped flute tone.
Fifteenth 2'	An open metal stop that produces foundation tone at the 2' pitch level. Also the 2' member of the Great Principal chorus.
Mixture IV	A compound stop of principal tones. Four notes in octave and fifth relationships sound together when a single key is depressed. As pitches progress upward, they "break" back to the next lower octave or fifth. Used to cap the Great principal chorus, adding brilliance and pitch definition throughout the entire compass.
Tromba 8'	Chorus reed stop of rich harmonic development. Can also be used as a solo voice.
Chimes	Typical Tubular Chimes.

## **IV. SPECIALIZED STOP CONTROLS**

Some organ stop controls do not turn voices on/off, but instead turn on/off console functions such as outlined in this Section.

Great to Pedal	Connects all Great stops to the Pedal.
Swell to Pedal	Connects all Swell stops to the Pedal.
Swell to Great	Intermanual coupler connecting all Swell stops to the Great manual.
Tremulant	This stop provides a vibrato effect, natural in the human voice and wind instruments.

Tuba Unenclosed Uncoupled	When activated the Solo Tuba 8 (2 <sup>nd</sup> Voice) on the Swell and Great manuals will be full volume and unaffected by the expression shoes. Also, the Swell stop will <u>not</u> couple to the Great manual when using the Swell To Great coupler. This allows the Swell Solo Tuba 8 to be used as an actual solo stop.
Harp (piston)	Actuates a Harp voice on the Swell manual which can be used with other Swell stops.
Piano Only (piston)	Actuates a Piano voice on the Great manual, but also disables all other stops in <u>all</u> divisions on the organ, including the pedals.
2 <sup>nd</sup> Voice Stop Controls	The Swell, Great and Pedal divisions each have a separate stop control which actuates a set of secondary voices engraved in red on applicable tabs. The use of the 2 <sup>nd</sup> Voice stop actuates the voice in lieu of the main voice listed on the stop.  <i><b>Note:</b> The second voices will <u>not</u> operate if the French Romantic voicing suite is selected.</i>
Piano Damper (toe stud)	Actuates sustain for the Piano voice. This control also actuates the Sostenuito function assigned to the Great manual.
Melody Coupler	When playing on the Great manual, the highest key played on the Great will automatically play all stops drawn on the Swell, in addition to those drawn on the Great. By choosing a Swell stop such as the Festival Trumpet, the melody played by the top note on the Great is accentuated.
Bass Coupler	Similar to the Melody coupler, however, in this case the lowest note played on the Great will also play all stops drawn in the Pedal Division. This allows voices normally played from the pedalboard to be heard without using the pedalboard.
Alternate Tuning	When activated, the organ's tuning will change to the alternate tuning selected from within the GeniSys Display.
All Swells To Swell	Couples the Gt-Pd expression shoe to the Swell expression shoe.

## V. PIANO AND HARP

Dedicated Piano and Harp voices are uniquely assigned to the LD-34b's keyboards. The Piano voice is exclusive to the Great manual and when turned on will automatically deactivate all other organ voices on the organ. The Piano is designed to be a "solo" instrument and is velocity sensitive so that the musician can control the playing dynamic, similar to that of an acoustic piano. The Harp voice is exclusive to the Swell manual and may be played in tandem with other Swell organ voices, especially appropriate with the softer Viola and Viola Celeste stops.



## **VI. EXPRESSION & CRESCENDO SHOES**

The organ's control pedals (called "shoes") control expression and crescendo.

- ❑ The left-hand side expresses the Great and Pedal Divisions.
- ❑ The center shoe expresses the Swell Division. It affects the loudness of Swell Division voices.
- ❑ The right-hand shoe is the Crescendo shoe. It is a master Crescendo for all divisions. It gradually adds stops as it is opened. Sequential green, yellow and red indicators within the GeniSys Display indicates relative pedal position. Indiscriminate use of the Crescendo, in lieu of careful registration, should be avoided.

The Crescendo B thumb piston is associated with the Crescendo shoe. Crescendo B accesses a second set of Crescendo registrations that can be different from the standard Crescendo registrations.

## **VII. TUTTI I and TUTTI II**

The Tutti I and II pistons are sets for full organ registrations. Tutti II has a larger, much louder registration, than Tutti I. The Tutti's are turned on and off by pressing manual thumb pistons TUTTI I or TUTTI II. The pistons are "toggled" meaning that pressing them a second time reverses the ON or OFF setting of the corresponding Tutti. Only one Tutti can be turned ON at a time. Pressing the other Tutti piston that is not turned ON will turn OFF the Tutti that was ON and turn ON the Tutti that was OFF. The *Cancel* piston button will turn OFF both Tuttis.

Red signal indicators within the GeniSys Display will illuminate when Tutti I or II is in operation. A second set of Tutti's can be programmed by the organist. Like the Crescendo, indiscriminate use of Tutti's should be avoided.

## **VIII. SETTING PISTONS**

### **SETTING GENERAL PISTONS**

Your Allen Organ's capture system lets you set stop registration combinations in each of its memories. The LD-34b contains ten General pistons, 5 of which are duplicated on toe studs; six divisional pistons for both Swell and Great divisions and four Pedal divisional toe studs. The LD-34b contains a (16) memory combination action. This means you have a total of 160 possible General piston combinations as well as 256 possible divisional combinations (Swell/Great/Pedal).

To set a General capture combination:

- ❑ First, select and depress the stops you wish to save.
- ❑ Press and hold the SET Piston.
- ❑ Press and release the desired GENERAL piston.
- ❑ Finally, release the SET Piston.

Remember, the General pistons are customarily set from soft to loud using graduated stop combinations. The pistons you have set "remember" the registration combinations that you have assigned to each of them. Each time a General piston is pressed, the registration assigned to it is activated. You can change stop registration combinations at any time by repeating the above procedures.

## SETTING DIVISIONAL PISTONS

The piston setting process for divisional pistons is the same as SETTING GENERAL PISTONS described above. Only Swell stops can be set with the Swell divisional pistons, Great stops with the Great divisional pistons and Pedal stops with the Pedal divisional toe studs.

## SETTING TOE PISTONS (STUDS)

Stop registration combinations may be set and drawn by toe studs, as well as by pistons. Toe studs, located on each side of the Expression and Crescendo shoes, are set in the same manner as thumb pistons. The toe studs on the left are duplicates of General Pistons. The Toe Studs on the right are Pedal Divisional Toe Studs.

To set a Pedal Divisional Toe Stud...

- ❑ Select the desired Pedal stops.
- ❑ Hold the SET button, and momentarily press the desired Pedal Toe Stud.
- ❑ Finally, release the SET button.

When you set a General Piston, that combination is set automatically on the Toe Stud of the same number. That is, setting General Piston 3 also places its combination on General Toe Stud 3.

***Note:** The organ's capture system is not operable until about six seconds after the organ is turned on.*

## RECALL PISTON

The "R" or Recall piston recalls the last registration setting prior to using any General or Divisional piston. For example;

- ❑ Press a General or Divisional piston/toe stud. The stop registration programmed on that particular piston/toe stud will appear.
- ❑ Manually register additional stops to the current stop registration.
- ❑ Now, press a different General or Divisional piston/toe stud. The stop registration programmed on that particular piston/toe stud will appear.
- ❑ Press the "R" piston. The previous stop registration, including those stops registered manually, will re-appear.

What happens is that the capture system takes a "snapshot" of the current stop registration and stores it within the Recall piston memory before it actually changes to the new stop registration selected. Then, when the "R" piston is pressed, the capture system "recalls" the previous registration stored before the last piston/toe stud selection was made.

## IX. REVERSIBLE PISTONS

The LD-34b is equipped with several Reversible pistons for the intermanual coupler stops. Reversible pistons, when pressed, toggle the state of a coupler stop. For example, if the coupler stop is turned off, pressing the associated Reversible piston for that stop will turn the stop on. The same is true in reverse, if the coupler stop is turned on, pressing the associated Reversible piston for that stop will turn the stop off.

## **X. ARTISTIC REGISTRATION**

*(Trained organists might not need to review this section.)*

Organ registrations fall into two broad categories: solo combinations and ensembles. A solo combination is one in which a melody is played on one keyboard, the accompaniment on another keyboard, and the pedal often provides a light bass line. Almost any stop or combination of stops will sound good as a solo voice. A contrasting tone quality should be chosen for the accompaniment, so that the accompaniment is softer than the solo voice. The pedal stops must provide a foundation for the sound without covering it.

Most 8' reed stops make interesting solo voices. The addition of a 4' flute or a flute mutation (e.g., Nasard or Tierce) to a reed such as the Trompette colors the sound further and increases its volume slightly. Adding an 8' flute to a reed will add body to the sound.

Flutes can be used alone or in combinations as solo voices. One special combination of flutes that creates an appealing and historically significant solo combination is the Cornet (pronounced kor-NAY). The Cornet is created by using Swell flute stops at these pitches: 8', 4', 2-2/3', 2' and 1-3/5'. This combination was used widely in Baroque organ music, but it is just as appropriate for some modern music. Useful variations of the Cornet may be achieved by eliminating the 4', the 2', or both.

When choosing stops for a solo voice, it is not always necessary to include an 8' stop. For example, since the 4' flute has a tone quality different from that of the 8' flute, the 4' flute can be used as an independent solo voice. By playing the solo an octave lower than written, the notes will sound at the correct pitch. In similar fashion, a 16' stop can be selected and the notes played an octave higher than written. Tonal variety will be gained, because each stop has its own tone color.

For accompaniment, the most desirable voices are the 8' flutes or strings on each manual. Celestes often make effective accompaniments. The correct choice depends on the volume of the solo tone (a soft solo voice requires the softest accompaniment stop), the element of contrast and the location of the solo stop. A bright, harmonically rich solo reed, for example, can be accompanied by either a string or flute, but the flute will often contribute greater interest because of its greater contrast.

Seek a "natural" balance of volume between solo and accompaniment. This will be especially easy to accomplish if the solo and accompaniment are under separate expression.

### **SUGGESTED SOLO REGISTRATIONS**

#### **CHIMES SOLO**

Swell: Viola 8', Viola Celeste 8'  
Great: Chimes  
Pedal: Lieblich Gedackt 16', Swell to Pedal

*Play solo on Great.*

#### **SOLO CORNET COMBINATION**

Swell: Gedeckt 8', Nachthorn 4', Nasard 2-2/3', Piccolo 2', Tierce 1-3/5'  
Great: Harmonic Flute 8'; or Erzähler Celeste II 8'  
Pedal: Lieblich Gedackt 16', Flute 8'

*Play solo on Swell.*

## FLUTE SOLO

Swell: Gedackt 8', Orchestral Flute 4'  
Great: Erzähler Celeste II 8'  
Pedal: Lieblich Gedackt 16', Swell to Pedal  
*Play solo on Swell*

## TRUMPET SOLO

Swell: French Trumpet 8'  
Great: Diapason 8', Octave 4'; Fifteenth 2'  
Pedal: Diapason 16', Octave 8', Choralbass 4'  
*Play solo on Swell.*

## FESTIVAL TRUMPET SOLO

Swell: Gedackt 8', Viola 8', Octave 4', Piccolo 2', Fourniture IV, Swell 2<sup>nd</sup> Voices  
Great: Diapason 8', Harmonic Flute 8', Octave 4', Spitzflöte 4', Fifteenth 2', Mixture IV, Swell to Great  
Pedal: Diapason 16', Octave 8', Choralbass 4', Mixture III, Waldhorn 16', Tromba 8', Great to Pedal, Swell to Pedal  
General: Tuba Unenclosed Uncoupled  
*Play solo on Swell*

These few combinations demonstrate basic techniques of solo registration. In creating registrations of your own, remember these three simple rules:

1. Seek tonal contrast between solo and accompaniment.
2. Be sure the solo is louder than the accompaniment.
3. Choose a solo whose character is appropriate to the specific piece.

## ENSEMBLE REGISTRATIONS

Ensemble registrations involve groups of stops that are played together, usually, but not always, with both hands on one keyboard. They are characterized by compatibility of tone, clarity, and occasionally power. Such registrations are used in hymn singing, choir accompaniments, and much of the contrapuntal organ literature.

Ensembles are created by combining stops. Two factors to be considered are: tone quality and pitch. Ensembles begin with a few stops at 8' pitch and expand "outward" in pitch as they build up. New pitches are usually added in preference to additional 8' stops.

Ensembles are generally divided into three groups or "choruses":

- The **Principal** chorus, the most fully developed, is represented in most divisions of the organ and at pitches from 16' (Diapason) to high mixtures. The Principal chorus is sometimes called the narrow-scale flue chorus, a reference to the relative thinness of principal pipes in relation to their length.
- The **Flute** chorus is also well represented with a diversity of stops at various pitches. Generally speaking, the Flute chorus is composed of less harmonically developed tones, and is smoother and of lesser volume than the Principal chorus. The Flute chorus is sometimes called the wide-scale flue chorus, owing to the generally "fatter" look of Flute pipes as compared to Principals.

- The **Reed** chorus includes those reed tones designed to be used in the ensemble buildup. Not all reed voices are ensemble tones. An Hautbois, for example, is usually a solo stop. The various Trumpets, Clairons, Posaunes, etc., are ensemble voices that add brilliance, power, and incisiveness to the sound.

The Swell Reed chorus of Waldhorn 16' and French Trumpet 8' represents an entity important to French organ music and the full ensemble of the organ. These stops create a "blaze" of harmonic richness that tops off the Principal and Flute choruses.

Another special ensemble combination important in French music is the Cornet, which was discussed in the section on solo registration. This combination can be used with the chorus reeds and mutations to create the "Grand Jeu." The Cornet is also useful in Romantic ensembles to add weight and thickness to the sound.

Here are typical ensemble combinations for the Swell and Great manuals:

### **GREAT**

1. Harmonic Flute 8', Spitzflöte 4'
2. Harmonic Flute 8', Spitzflöte 4', Fifteenth 2'
3. Diapason 8', Octave 4'
4. Diapason 8', Octave 4', Fifteenth 2'
5. Diapason 8', Octave 4', Fifteenth 2', Mixture IV
6. Diapason 8', Harmonic Flute 8', Octave 4', Spitzflöte 4', Fifteenth 2', Mixture IV

### **SWELL**

1. Gedackt 8', Viola 8'
2. Gedackt 8', Viola 8', Nachthorn 4'
3. Gedackt 8', Viola 8', Nachthorn 4', Piccolo 2'
4. Gedackt 8', Viola 8', Octave 4', Nachthorn 4', Piccolo 2'
5. Gedackt 8', Viola 8', Octave 4', Nachthorn 4', Piccolo 2', Fourniture IV
6. Gedackt 8', Viola 8', Octave 4', Nachthorn 4', Piccolo 2', Fourniture IV, French Trumpet 8'

The use of the *Swell to Great* coupler allows these separate ensembles to be combined on the Great manual. For example, the Great #5 and Swell #4 registrations coupled together and played on the Great combine to form a nice round hymn combination.

The Pedal ensemble is created in much the same way as the manual ensembles, starting at 16' pitch instead of 8'. Be careful that the volume of the pedals is not greater than that of the manuals. Although the manual to pedal couplers are useful in bringing clarity to the pedal line, especially on softer registrations, avoid the temptation to rely constantly on one or two 16' stops and a coupler. Please note that the softest stops and flute mutations are normally not used in ensembles.

### **FULL ORGAN**

Due to the immense capabilities of your Allen Organ, every stop and coupler on the instrument could be used simultaneously. In good registration practice, however, the organist would not haphazardly put on every stop on the instrument. For best results, listen and include only those stops whose contribution to the fullness and brilliance of the ensemble you can hear when they are added. Eliminate soft stops and solo stops that make no audible contribution.

This short treatment barely scratches the surface of organ registration. For those interested in gaining further insight into this vital area of organ playing, we recommend the following resources:

Audsley, George Ashdown. *Organ Stops and their Artistic Registration*.  
Hialeah, FL: C.P.P. Belwin, 1985.

Irwin, Stevens. *Dictionary of Pipe Organ Stops*. 2nd ed.  
New York: Macmillan Books, 1983.

Cherrington, Dr. Sally. *A Church Organist's Primer. Volumes I, II, & III*.  
Allen Organ Company. DVD  
AOC PN: 031-00092.

## **XI. TRANSPOSER**

Vast computer capability makes it possible to perform the sometimes difficult task of transposing, while allowing the organist to play in the notated key. The GeniSys™ Display controls the operation of the Transposer.

Transposition to any of the twelve musical keys is possible. When the organ is turned ON, the Transposer defaults to the neutral or zero (0) position. The pitch can be raised a maximum of five half-steps or lowered a total of seven half-steps. Be aware that the Transposer's range settings "wrap around" from the plus five half-step setting to the minus seven half-step setting (or vice-versa).

The Transposer button within the GeniSys™ Display will change to a red color any time the Transposer setting is moved from the zero (0) or neutral pitch position.

Why Transpose?

- ❑ Because a song's range does not always suit the vocal range of a particular singer. By adjusting the Transposer, the piece can be sung more comfortably and effectively.
- ❑ Because some instruments are non-concert pitch. A trumpet in B<sup>b</sup>, for example, can play the same music as the organist, if the Transposer knob is set two half steps lower.
- ❑ Because hymn singing can sometimes be improved by a more favorable key selection.

## **XII. ACOUSTIC PORTRAIT™**

Allen Organs are the only digital organs to bring the science of sampling to acoustics! Ordinary electronic reverb is a synthetic imitation of acoustics “applied to” the sound, not created as an integral part of it. Acoustic Portrait™ produces the real thing in exacting detail!

Acoustic Portrait™ begins with a sampling process using impulse responses that measure an actual room’s acoustic properties. These measurements are then stored in the organ’s computer memory. Through an advanced real-time mathematical process called “convolution”, the acoustics of the sampled room actually become an integral part of the organ’s sound, producing a noticeably smoother, more natural result than synthetic reverb. Allen engineers have recorded the acoustics of cathedrals and other acoustically desirable buildings throughout the world. With advanced processors (DSP) and patented low-latency convolution algorithms, Acoustic Portrait™ reproduces the true acoustic response of each original room with stunning realism! Each organ equipped with Acoustic Portrait™ features 10 different Acoustic Portrait selections, ranging from intimate rooms to cavernous cathedrals.

### Available Reverb Selections:

1. Pipe Chamber
2. Small Theatre
3. Small Church
4. Medium Room 1
5. Medium Room 2
6. Medium Room 3
7. Large Room 1
8. Large Room 2
9. Cathedral
10. Large Cathedral

Acoustic Portrait is controlled within the GeniSys™ Display and must be turned ON to hear the selected reverb selection. The Acoustic Portrait™ selection as well as the gain (volume), measured in dB (decibels), can be accessed and adjusted within the GeniSys™ Display.

## **XIII. MULTIPLE VOICE SETS**

The LD-34b provides the versatility of two separate and distinct organs in one console. Choose from American Classic or French Romantic for the stop list that perfectly complements your music. The specifications are comprised of unique pipe samples from the world’s finest examples of each major organ-building style. The touch of a button changes the entire organ to the stop list of your choice! The active voice specification can be viewed within the GeniSys™ Display.

## **XIV. INSTALLATION, VOICING, AND CARE OF THE ORGAN**

### **INSTALLATION**

Wherever your organ may be situated, careful installation is a prerequisite to successful results. Your Allen representative is well qualified to guide you in planning the finest possible installation. Factory assistance in planning the installation is also available and may, in fact, be sought by your Allen Organ representative.

### **VOICING**

Your organ presents unprecedented accuracy in the scaling and voicing of each note of every stop. Should you require that these parameters be changed, your Allen Organ representative is able to help make such changes. Final adjustments in scaling and voicing involve procedures that are best left to an expert. These adjustments normally are a part of installation, and once done, should not require changes. If the organ is moved to a new location or major changes are made to the acoustical properties of the room the organ resides in, the instrument may need to be tonally finished again.

### **MEMORY SYSTEM**

The memory for the capture system and other miscellaneous settings on your Allen Organ utilizes revolutionary “flash” technology for storage. This allows capture settings and related items to be retained in memory when the organ is switched off or unplugged. No batteries are ever required which means that regular battery maintenance, normally required every few years, has been eliminated.

### **CARE OF THE ORGAN**

Your Allen Organ constitutes a major advance in long-term maintenance-free operation. There are no regular maintenance procedures required and, therefore, no periodic maintenance schedules to be observed.

Reasonable care will keep the instrument looking beautiful for years to come. The wood surfaces may be cleaned using a soft cloth dampened with lukewarm water. A mild solution of lukewarm water and dish detergent may be used to remove fingerprints, etc. Polish dry with a soft cloth. Do not use wax, sprays or oils on the finish. Satin finished surfaces will take on a semi-gloss appearance when waxed and will eventually become yellowed.

Keys and stop tablets should be cleaned in the following manner: Use two clean cloths. Immerse one in clear, lukewarm water and wring it thoroughly damp dry. Loosen the dirt with this cloth, and then polish immediately with the dry cloth. Do not use soap or detergent on keys or stop tablets.

To polish the clear music rack, a furniture wax polish may be sprayed on a soft dry cloth and rubbed on the front of the music rack. Keep the wax off of the wood finishes. This will help keep the music rack clear.

You have purchased a remarkable organ that not only faithfully reproduces the organ traditions of the past but also anticipates the innovations of the future. Should you have questions that are not addressed in this manual, please do not hesitate to contact your local Allen Organ representative.

Welcome to the family of satisfied Allen Organ owners!



## XV. SAFETY INFORMATION

### USA ONLY

#### CAUTION

Never plug the instrument into any current source other than 110 to 120 volts, 50/60 Hertz alternating current (AC). A verified grounded outlet is essential to proper operation and protection of the instrument. Proper polarity should be checked with an AC circuit analyzer before connecting the organ.

Do not change the cable plug or remove the ground pin or connect with a two-pole ground lift adapter.

If you are in doubt about your electrical connection, consult your local electrician or power company.

In facilities where circuit breakers are turned off between uses (as for example, between worship services), the circuit breaker affecting the organ console AC power should have a guard installed to prevent it from accidentally being switched off.

It is important that you read and comply with all instructions and labels that might be attached to the instrument.

*Warning:* This equipment generates, uses, and can radiate radio frequency energy and, if not installed and used in accordance with the instruction manual, may cause interference to radio communications. It has been type tested and found to comply with the limits for a Class B Computing Device in accordance with the specifications in Subpart J of Part 15 of FCC Rules, which are designed to provide reasonable protection against such interference in a residential installation. Should this equipment cause interference to radio communications, the user at his own expense will be required to take whatever measures may be necessary to correct the interference. Whether this equipment actually causes the interference to radio communications can be determined by turning the equipment off and on. The user is encouraged to attempt to correct the interference by one or more of the following measures:

Reorient the receiving antenna.

Relocate the organ with respect to the receiver.

Move the organ away from the receiver.

Plug the organ into a different electrical outlet, so that the organ and receiver are on different branch circuits.

If necessary, the user should consult the dealer or an experienced radio technician for additional suggestions.

CE mark shows compliance with the EMC Directive.

## XVI. GENISYS™ DISPLAY REFERENCE GUIDE

### INTRODUCTION

The GeniSys™ Display is an interface that controls many organ functions and a variety of MIDI functions as well as many other functions. The GeniSys™ Display includes an LCD (liquid crystal display) GUI (graphical user interface) touch screen that displays a variety of functions, at any given time. The GeniSys™ operation software is vast. While the GeniSys™ Display operation is simplistic, many of the features require more in-depth details. This guide will attempt to explain those details.

### A. BASIC OPERATION

#### 1. Start-Up Sequence

Turn on the organ's main power switch. The organ will take several seconds to start-up before it is ready to be played. It is important that no keys, pedals or stop controls are pressed or operated while the organ is starting up as this could cause errors to occur. During the start-up sequence, the GeniSys™ Display will display the Allen Organ logo and also indicate the main computer's status. Once the organ has completed starting up, the GeniSys™ Display will display the "home" screen indicating the organ is ready to play.



**Important:** The Allen Organ includes several self-testing features. If a warning is displayed within this sequence, please contact your Allen authorized representative immediately!

The "Home" screen displays the current Transposer setting, capture memory level (and lock condition of the memory level), expression/crescendo positions, voicing suite, Tutti and Crescendo B selections (if active) and the last piston/toe stud selection (if active).

To access a specific function, simply touch a button or area of the screen. For example, to change the Transposer setting, touch the Transposer button and GeniSys™ Display will enter the Transposer control screen. To return to the "Home" screen, touch the HOME button.

Most of the function screens contain two navigation buttons; BACK and HOME. The BACK button will move the screen back to the previous screen/function/menu while the HOME button will return the display to the "Home" screen.

The GeniSys™ Display screen is very bright so that the contents of the screen can be seen in bright light environments. However, there may be times where the brightness of the screen can interfere with the organist and/or environment, ex: candlelight or evening services. GeniSys™ Display includes a special “hidden” function to turn off the display for those times. To turn off the display, simply touch the screen anywhere within the expression/crescendo bar graph area and the screen will turn off (see illustration below).

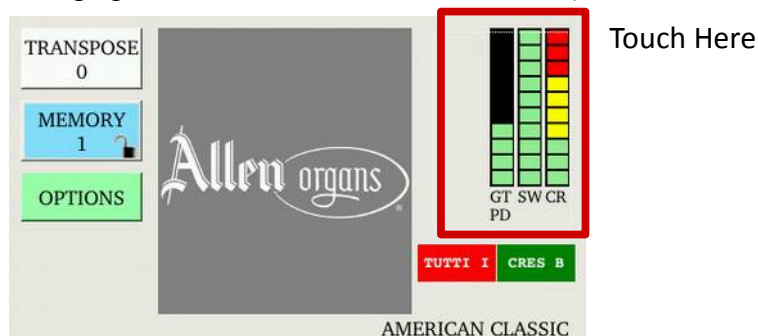

To turn the display back on, touch any area of the screen.

## 2. Capture Memory Physics

The capture memories allow you to save different registrations on each piston/toe stud. This means General Piston 1 on Memory 1 can be totally different from General Piston 1 on Memory 2, 3, 4, etc. Select a different capture memory level by touching the Memory level button on the GeniSys™ Display and then use the up and down buttons to select a different memory level number. Return to the *Home* screen by touching the HOME button.

## 3. Locking Capture Memories

All memories, except Memory 1, may be locked or unlocked individually to prevent unintentional or unauthorized changes to that memory’s contents.

**Note:** Memory 1 remains unlocked as a convenience to visiting or substitute organists (*if applicable*).

The Memory level button within the GeniSys Display includes a “padlock” illustration to indicate whether the selected capture memory level is locked or unlocked.

To lock a selected memory level, touch the Memory level button on the GeniSys™ Display to enter the memory level selection screen. Then, touch the padlock button to enter the memory combo-lock screen. Enter a three-digit lock code using any combination of the six (6) available buttons on the display. Once a code has been entered, press the ENTER button to lock the memory level. If a change to a number is needed before the ENTER button is pressed, press the RESET button to clear the code to start over. Once the ENTER button is pressed, the memory level will be locked and the RESET button will only clear the code number displayed. The lock code needs to be re-entered to unlock the memory level.

Touch the HOME button to return to the *Home* screen.

**Remember!** Choose an easy to remember three-digit code.

**Note:** Each capture memory level lock code can be different!



#### 4. Unlocking Memories Using Your Code

To unlock a selected memory level, touch the Memory level button on the GeniSys™ Display to enter the memory level selection screen. Then, touch the padlock button to enter the memory combo-lock screen. Using the six (6) available buttons, enter the three-digit lock code that was used to lock the selected memory level. Once the code has been entered, press the “ENTER” button to unlock the memory level. If a change to the number is needed before the “ENTER” button is pressed, press the “RESET” button to clear the code to start over. If the correct code was entered, the memory level will unlock, otherwise the memory level will remain locked.

Touch the HOME button to return to the *Home* screen.

#### 5. Stoplist Library™

The LD-34b is equipped with two voicing suites; American Classic and French Romantic.

To change the voicing specification, advance to the 'STOPLIST LIBRARY' menu function within GeniSys™ Display; touch:

**OPTIONS >> STOPLIST LIBRARY.**

The display will indicate the current voicing specification loaded. To change the voicing specification, use the UP and DOWN buttons. Once the desired voicing specification is displayed, touch the LOAD button. The display will indicate the selected voicing specification is loading. Once the voicing specification has loaded, the capture system will automatically cancel all stops indicating the organ is now ready to play.

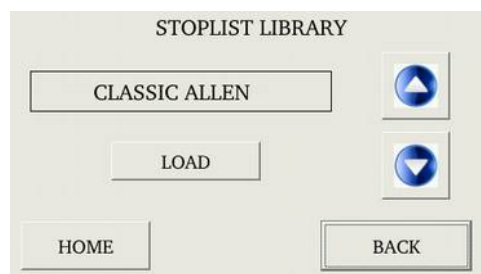

Touch the HOME button to return to the *Home* screen or the BACK button to return to the previous menu screen.



**Important:** The organ will not be able to be played while a new voicing specification is loading.

#### 6. Acoustic Portrait™

Several Acoustic Portrait parameters are controlled within GeniSys™ Display. To access the Acoustic Portrait control screen within GeniSys™ Display; touch:

**OPTIONS >> ACOUSTICS.**

From this control screen, Acoustic Portrait can be turned on or off, the Acoustic Portrait selection may be changed and the gain (volume) may also be adjusted. To turn Acoustic Portrait on or off, touch the ON/OFF button. The button will “toggle” the on or off status.

The gain is displayed in dB (decibels). The gain range is adjustable from +6dB to minus 35dB. Minus 35dB is the least amount of gain while +6dB is the most amount of gain available. To change the gain value, touch the gain value button to highlight it and then use the UP and DOWN buttons to change the gain value.

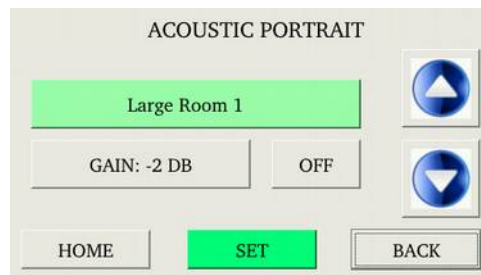

To change the active Acoustic Portrait selection, touch the Acoustic Portrait selection button and use the UP and DOWN buttons to change to a different Acoustic Portrait selection. Once the desired selection is displayed, touch the SET button. Loading takes approximately 3 to 4 seconds to complete.

Acoustic Portrait™:

Available Reverb Selections

1. Pipe Chamber
2. Small Theatre
3. Small Church
4. Medium Room 1
5. Medium Room 2
6. Medium Room 3
7. Large Room 1
8. Large Room 2
9. Cathedral
10. Large Cathedral

## 7. Alternate/Global Tuning

Allen Organs offer seven **Alternate Tunings**, plus one standard tuning. In addition, the Global Tuning feature allows the overall tuning of the organ to be adjusted from the standard A-440 tuning  $\pm$  100 cents.

The available tuning options are accessible from the GeniSys™ Display. To access the Tuning Options control screen; touch:

*OPTIONS >> TUNING.*

To select a different *Alternate Tuning*, touch the Alternate Tuning button to highlight the selection and then use the UP and DOWN buttons to select an *Alternate Tuning*. The organ's overall tuning will be changed to the selected *Alternate Tuning*, by actuating the stop control engraved "ALTERNATE TUNING".



Any time the ALTERNATE TUNING stop is turned off, the organ will revert to the Classic style tuning.

**Note:** *The remaining tunings are of historical interest, but are limited in application to modern music. When selected, it is normal for some intervals to sound out of tune.*

Alternate Tunings:

1. Romantic
2. Classic
3. Baroque
4. Kirnberger 3
5. Werckmeister 3
6. Just Intonation
7. Young 2
8. Pythagorean

**Global Tuning** allows the organist to adjust the pitch of the entire organ. *Global Tuning* can be adjusted either  $\pm$  100 cents from A-440 pitch. To adjust *Global Tuning*, touch the Global Tuning button to highlight the *Global Tuning* value. Then, use the UP and DOWN buttons to adjust the tuning value.

Touch the HOME button to return to the *Home* screen or the BACK button to return to the previous menu screen.

**Note:** The Alternate and Global Tuning adjustments are retained in memory when the organ is powered off.

## 8. Unlocking All Capture Memories

There may be times when capture memory lock codes are lost or forgotten. The Unlock All Capture Memory function unlocks all capture memory levels including those memories other organisms may have locked. However, programmed registrations on the capture memory levels will remain unchanged.

To access the Unlock All Capture Memory function, touch:

*OPTIONS >> CONFIGURE CONSOLE >> MORE >> UNLOCK ALL CAPT MEM*

Enter code 2 – 5 – 5 by touching the number buttons on the display and then touch the ENTER button to unlock all the capture memory levels.

Touch the HOME button to return to the *Home* screen or the BACK button to return to the previous menu screen.

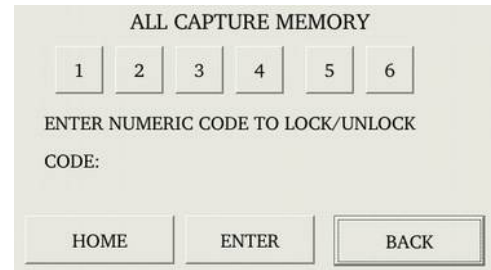

The screenshot shows a screen titled "ALL CAPTURE MEMORY". At the top, there is a header "ALL CAPTURE MEMORY". Below the header is a numeric keypad with buttons for digits 1 through 6. Underneath the keypad, the text "ENTER NUMERIC CODE TO LOCK/UNLOCK" is displayed, followed by "CODE:". At the bottom of the screen, there are three buttons: "HOME", "ENTER", and "BACK".

## B. USB OPERATION

### 1. USB Memory Port

On the LD-34b, the USB memory port is not accessible as it is located on the inside of the organ. However, the USB port is equipped with a specially programmed USB flash device for the LDS church. The USB flash is required for many of the GeniSys™ features to operate correctly.



### 2. GeniSys™ Recorder

GeniSys™ instruments contain the added versatility of a built-in console sequence recorder. Similar to the operation of an external MIDI sequencer, the GeniSys™ Recorder will record and playback an organist's performance in exacting detail. Every key, pedal, piston, stop and expression movement is recorded and played back as it was originally recorded by the organist. Performances are saved and loaded for playback on the USB flash device. The GeniSys™ Recorder is limited to a single-pass recording.

To access the GeniSys™ Recorder; touch:

*OPTIONS >> AUTO PLAY >> RECORDER.*

The GeniSys™ Recorder contains many display functions. Here is a quick breakdown of those functions and what they do:

Control Function:

**PLAY:** PLAY mode will play the selected song file number.

**RECORD:** RECORD mode will record a performance and save the recorded performance data as the selected song file number.

**DELETE:** DELETE mode will delete the selected song file number.

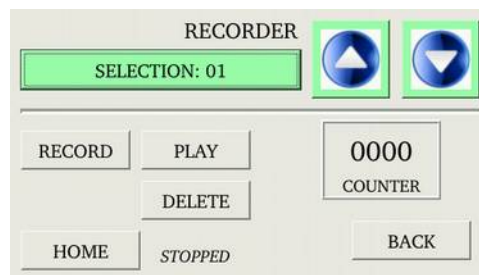

#### Selection Song File Number:

Any file number between 01 and 99 may be selected. To select a song file number, touch the Selection button to highlight the Selection. Then, use the UP and DOWN buttons to select a song file number.

#### Counter:

The counter indicates the current position of the Recorder within the selection song file number.

#### Recorder Status:

The Recorder Status is located at the bottom of the display and indicates the current status of the recorder; Stopped, Playing, Recording.

#### Delete a Song File:

To delete the selected song file number, touch the DELETE button.



**Important!** If a selected song file number is not located, the display will indicate the file does not exist.

## Play a Song File

To play the selected song file number, touch the PLAY button.



**Important!** If a selected song file number is not located when playback is started, the display will indicate the file does not exist and playback will not begin.

To “pause” playback, touch the PAUSE button. The counter will stop counting and the song file will stop playing. To resume playback, touch the PLAY button. The song file will “continue” from the current counter value.

**Note:** The counter value cannot be changed from its current value.

To stop playback, press the STOP button. The counter will reset to zero (0000) and the song file will stop playing.

## Record a Song File:

First, select a song file number.



**Important!** If the selected song file already exists when a recording is started, the display will indicate the file exists and recording will not begin. Either delete the selected song file number or select a different song file number to continue.



**Hint!** To ensure the console setup information is recorded within a song, perform these steps after the recording has started:

- Press the **CANCEL** piston. This will turn off any stops which are turned on and also transmit and record the currently selected capture memory level at the beginning of the song. Doing this will ensure the organ is set to the correct capture memory level when the song is played back preventing the potential for incorrect piston registrations to be selected.



**Important!** The piston registration settings used within a song is dependent on the current capture memory settings within the organ at the time the song is recorded. If the piston registrations are changed after a song has been recorded, the piston registrations will not be the same when the song is played back and the song will not sound as it was originally recorded.

- Select a piston registration or manually select stops.
- Move the expression shoe(s) and set them to a desired position. Doing this will record the organ’s volume information within the song. This way when a song is played back, the organ’s volume will be set to the correct level.

To begin the actual recording, touch the RECORD button. The counter will begin counting to indicate the Recorder is now recording. At this point, begin playing the organ (see Hint! above). Remember, all key, pedal, piston, stop or expression movements will be recorded.

To “pause” during recording, touch the PAUSE button. The counter will stop counting indicating recording has stopped. To continue recording, touch the CONTINUE button. The Recorder will resume recording from the current counter value.



**Important!** Any changes; registration, expression, etc. made to the organ while the recording has been paused will not be recorded!

**Note:** The counter value cannot be changed from its current value.

**Note:** Upon completion of a recording, press the **CANCEL** piston to turn off all of the stops and also move the expression shoes to their lowest position.

To stop recording, touch the STOP button. The counter will reset to zero (0000) and the song file will stop recording. To playback the recording touch the PLAY button.

Touch the HOME button to return to the *Home* screen or the BACK button to return to the previous menu screen.



### 3. Hymn Player

The LD-34b contains a Hymn Player which plays pre-recorded LDS hymns.

**Note:** Additional LDS hymns cannot be added to the existing list of available hymn selections.

To access the Hymn Player; touch:

*OPTIONS >> AUTO PLAY >> HYMN PLAYER.*

To select a Hymn, touch the Hymn title to highlight the selection. Then, use the UP and DOWN buttons to change the Hymn.

To play the selected Hymn, touch the PLAY button.

To stop Hymn playback, touch the STOP button.

#### Playback Parameters:

To change the value of any of the playback parameters, touch the associated parameter button to highlight it and then use the UP and DOWN buttons change the parameter value.



Intro: Determines whether an Introduction passage is played before the Hymn.

**Note:** *Intro value cannot be changed during playback.*

Tempo: Tempo may be adjusted up or down in increments of 10. Maximum tempo value is plus/minus 50.

Verses: Maximum number of verses is 9.

Pitch: Pitch may be raised or lowered in half-step increments. Standard Transposer range is applicable; pitch can be raised a maximum of five half-steps or lowered a minimum of seven half-steps.

**Note:** *Pitch value cannot be changed during playback.*

Volume: Sets the overall volume of the organ relative to the expression shoe position(s) for hymn playback. Volume range is 1 (softest) through 10 (loudest).

**Note:** *Volume cannot be adjusted during playback.*

Language: Changes the Hymn title language.

**Note:** Both the Tempo and number of Verses may be adjusted during hymn playback.

Touch the HOME button to return to the *Home* screen or the BACK button to return to the previous menu screen.

#### 4. Performance Player

The LD-34b contains a Performance Player which plays pre-recorded LDS Performances.

**Note:** Additional LDS Performances cannot be added to the existing list of available selections.

To access the Performance Player; touch:

*OPTIONS >> AUTO PLAY >> PERFORMANCE PLAYER.*

To select a Performance song title, touch the Performance song title to highlight it and then use the UP and DOWN buttons to change the performance title.

To begin playback, touch the PLAY button. To stop playback, touch the STOP button.

To adjust the volume of a Performance, touch the volume button to highlight it and then use the UP and DOWN buttons to adjust the value.

Volume range is 1 (softest) through 10 (loudest).

**Note:** Volume cannot be adjusted during playback.



#### 5. Capture Load/Save

GeniSys™ instruments can both save and load capture registration data to the USB flash device. Capture registrations, piston configuration, MIDI settings, Crescendo/Tutti B settings can be saved and loaded.

To access the Capture Save/Load feature, touch:

*OPTIONS >> CONFIG CONSOLE >> CAPTURE SAVE/LOAD.*

The Capture Save/Load feature contains several functions. Here is a quick breakdown of those functions and what they do:

**Mode Select:** LOAD, SAVE or DEL.

**LOAD:** Loads a selected capture file number.

**SAVE:** (4) options (Type Select):

“ALL” Saves all capture registrations, piston configuration, MIDI settings, Crescendo/Tutti B settings.

“MEM XX” Saves only the selected capture memory level.

“PISTON CONFIG” Saves only the piston configuration data.

“CRESC/TUTTI B” Saves only the Crescendo/Tutti B data.

**DELETE:** Deletes the selected capture file number.

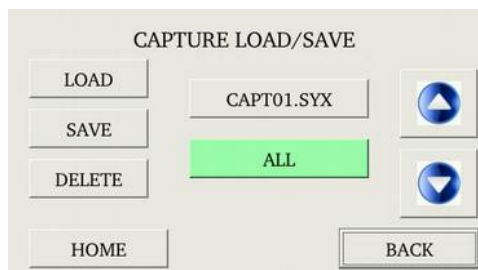

#### Select a Capture File:

To select a capture file to either save or load, touch the capture file number to highlight it, then use the UP and DOWN buttons to select a file number.

#### Load a Capture File:

To load a selected capture file number, touch the LOAD button. Then, touch the ACT button to start the load process. The display will indicate the status once completed.



**Important!** If a selected capture file number is not located, the display will indicate the file does not exist. Select a different capture file number to proceed.

### **Save a Capture File:**

To save the selected capture file number, touch the SAVE button. To change the type of data to save, touch the Type Select button to highlight it and then use the UP and DOWN buttons to change the data type. Touch the ACT button to start the save process. The display will indicate the status once completed.



**Important!** If a selected capture file number already exists, the display will indicate the file exists. Either delete the selected capture file number or select a different capture file number to proceed.

### **Delete a Capture File:**

To delete a the selected capture file number, touch the DELETE button. Then, touch the ACT button to delete the capture file. The display will indicate the status.



**Important!** If a selected capture file number is not located, the display will indicate the file does not exist. Select a different capture file number to proceed.

Touch the HOME button to return to the *Home* screen or the BACK button to return to the previous menu screen.

## C. ADVANCED OPERATION

### 1. Configuring General Pistons

This procedure enables pistons to control stops that are normally not controlled by those pistons.



**Important!** The Piston Configuration is common to all capture memories.

For example:

- (1) Pistons can be configured to control only certain specific stops.
- (2) A piston can be configured so that it will only affect the Tremulant stops.
- (3) A General piston can be configured to respond like a Divisional Piston.

**Note 1:** Changing the configuration of a piston will *not affect the registrations* previously remembered by that piston prior to its reconfiguration.

**Note 2:** Re-configuring a piston does not change its MIDI channel assignment.

To access the Configure Piston feature, touch:

*OPTIONS >> CONFIG CONSOLE >>  
CONFIGURE PISTONS*

At this point, pressing any piston will actuate stops controlled by that particular piston.

To return to the previous menu, touch the BACK button.

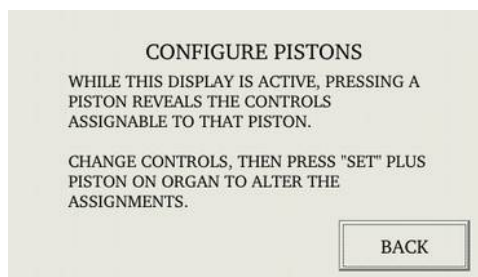

### EXAMPLE CONFIGURATIONS

#### **To reconfigure a piston to control only the MIDI stops:**

Select just the MIDI stop controls. Press and hold the **SET** piston. Then, while holding **SET**, press a General piston that you want only the MIDI stops to respond on. Release both. The General piston just pressed will now only be able to program the MIDI stop controls and will no longer affect other stops.

#### **To reconfigure a General Piston so it controls only the Swell Division stops:**

Select *all* of the Swell division stops. Press and hold the **SET** piston. Then, while holding **SET**, press a General piston that you want only the Swell division stops to respond on. Release both. The General piston just pressed will now only be able to program the Swell division stops and will no longer affect other stops.

#### **To add the “Swell To Great” Intermanual Coupler to the Great Divisional Pistons:**

Select *all* of the Great Division stops controls and also the “Swell To Great” intermanual coupler. Press and hold the **SET** piston. Then, while holding **SET**, press each Great Divisional Piston, in sequence while holding **SET**. Release **SET** when completed. The “Swell To Great” coupler can now be registered to the Great Divisional pistons.

#### **To reconfigure a General/Divisional Piston so it controls only the Tremulant stops:**

Select *all* of the organ’s Tremulant sop controls. Press and hold the **SET** piston. Then, while holding **SET**, press a General/Divisional piston. The General/Divisional piston just pressed will now only be able to program the Tremulant stops and will no longer affect other stops.

**Remember:** The above examples only determine which stops will become accessible by the reconfigured pistons; *they will not change any previously saved registrations.*

## 2. Restoring Original Factory Settings

To access the reinitialize feature, touch:

**OPTIONS >> CONFIGURE CONSOLE >> MORE >> REINITIALIZE**

Certain functions can be restored to the original factory settings. They are:

- Piston Configuration
- Tutti/Ventil B
- Crescendo B
- Capture Memory
- MIDI Settings

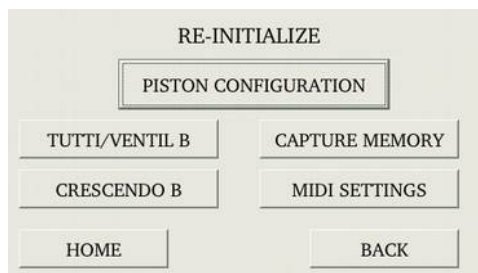

The Piston Configuration re-initialization includes all the Configure Piston settings. The MIDI Settings re-initialization includes all MIDI program change mapping. The Capture Memory re-initialization will reset the last available capture memory back to factory default registrations (*if applicable*).

Each of these functions can be restored individually. Touch the associated function to be restored. The display will ask to confirm the function selected to be restored. Touch “YES, I AM SURE” to reinitialize the function or “NO” to abort.

Touch the HOME button to return to the *Home* screen or the BACK button to return to the previous menu screen.

## 3. Self Check; Stop Action and Capture

This feature self-checks the capture system. The test insures each stop is functioning properly and is controllable by the capture system.

To access the Self Check function, touch:

**OPTIONS >> CONFIGURE CONSOLE >> MORE >> SELF CHECK**

To start the self-check, touch the START button. The button will highlight indicating the selection and the stops will turn on and off consecutively one at a time.

Lumitech stops indicators will turn on and off one at a time and drawknobs/rockertabs will move in and out or down and up one at a time. If any stop position does not light or move please notify your certified Allen service technician.

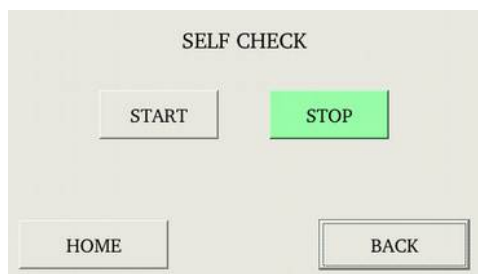

During the testing process you can stop the Self Check function at any time touching the STOP button.

Touch the HOME button to return to the *Home* screen or the BACK button to return to the previous menu screen.

## 4. Sostenuuto (optional – requires Sustain Kick Switch)

*Sostenuuto* is an Italian word meaning “sustained.” Unlike the sustain switch, which sustains any notes played as long as the sustain switch is held on, the *Sostenuuto* switch sustains only the notes being held at the very moment it is pressed. *Sostenuuto* is actuated by the organ’s MIDI Sustain switch (optional) located to the left of the Great/Pedal expression shoe. The *Sostenuuto* function must first be enabled before using it.

To access the Sostenuto function, touch:

**OPTIONS >> CONFIGURE CONSOLE >> SOSTENUTO.**

The display will indicate which manual Sostenuto is assigned to and indicate the current on/off status.

**Note:** The manual which Sostenuto is assigned to cannot be changed, only the on/off status can.

To turn Sostenuto “on”, touch the ON button. To turn Sostenuto “off” touch the OFF button.

Touch the HOME button to return to the *Home* screen or the BACK button to return to the previous menu screen.



**Important!** Sostenuto will affect the internal voices of the organ as well as a MIDI instrument connected to the MIDI output. The Sustain function will operate in tandem with the Sostenuto function. Check your specific MIDI instrument’s owner’s manual to verify that it will receive and/or respond to MIDI Sostenuto messages.

## 5. Modifying Crescendo and Tutti B Settings

A second set of Crescendo and Tutti settings can be altered to suit the organist’s needs.

To access the Crescendo/Tutti B function, touch:

**OPTIONS >> CONFIGURE CONSOLE >> CRESC/TUTTI B**

There are two modes available; "SET" and "SHOW".

**SET:** Set mode allows the organist to edit a Crescendo B sequence.

**SHOW:** Show mode allows the organist to preview the programmed Crescendo B sequence.

Touch the SET or SHOW button to highlight and select which mode will be active.

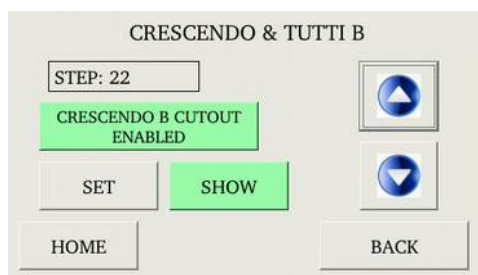

To view the stops registered on the second (B) Tutti I or Tutti II, press either Tutti piston. This will cause all associated stops programmed on the Tutti selected to turn on.

**Important:** Do not use the Crescendo shoe while within the Crescendo B/Tutti B function!

### Setting a Crescendo B Sequence:

Crescendo includes 22 step positions, evenly dispersed along the Crescendo shoe’s range of travel. To set the Crescendo B sequence, touch the SET button to highlight it and activate the program mode. Then, using the UP and DOWN buttons, select a STEP position. The "STEP" indicator displays either "step --" to indicate position 0 (*Crescendo shoe off*) or any step between 1 and 22.



**Important!** While in SET mode, moving through the step positions using the UP and DOWN buttons will not cause stops to turn on or off indicating what registration is programmed on a particular step.

To set a Crescendo B sequence, use the UP and DOWN buttons to select step 1. Adjust the stops to a suitable registration for step 1. (*Note: You can play the organ at any time to hear your selected registration*) To save the selected stop registration to step 1, press and hold the SET piston. Then, while holding SET, press the CRES B button. Step 1 is now programmed. Repeat the above procedure to set all available crescendo step positions.

## Preview/Editing A Crescendo B Sequence

Touch the SHOW button to highlight it and activate the preview mode. Use the UP and DOWN buttons to move through the step positions. The stops will turn on or off indicating the stop registrations programmed on each step position.

To make a change to a step position, touch the SET button to highlight it and enter the program mode. Stops can now be turned on or off to change the step registration. Once changes are complete, press and hold the **SET** piston. Then, while holding **SET**, press the **CRES B** piston to program the changes to the step position. Return to SHOW mode by touching the SHOW button on the display. Use the UP and DOWN buttons to move through the step positions.

## Celestes and Tremulant Cutout:

To disable the Celestes and/or Tremulants at any of the available Crescendo B steps positions, first select a step position where the cutout will begin. Touch the SET button to enter the programming mode. Then, touch the “Crescendo B Cutout Enabled” button to highlight it. Doing this will set the cutout starting point on the displayed step position. All subsequent step positions will also be automatically set.

**Note:** Registrations and/or the memory settings for the PISTONS are not affected by resetting the Crescendo B.

## Play the Organ Using Crescendo B

The *Home* screen must be displayed. Press HOME to return to the *Home* screen. Press the **CRES. B** piston. On the GeniSys™ display, the green CRES B indicator will illuminate below the expression bar graphs. Depress the Crescendo shoe and play the organ.

## Editing/Preview Tutti B Registrations

While in the Crescendo B and Tutti B programming function, pressing a Tutti piston will change the STEP display to indicate which Tutti piston was pressed. If SHOW mode is selected, the stop registration programmed on the Tutti selected will be activated. To change the selected Tutti, touch the SET button to highlight it and activate and enter the program mode. Stops can now be turned on or off to change the registration. Once changes are complete, press and hold the **SET** piston. Then, while holding **SET**, press the **TUTTI** piston selected to save the changes. Return to SHOW mode by touching the SHOW button on the display.

## Play the organ Using Tutti B

The *Home* screen must be displayed. Press HOME to return to the *Home* screen. Press the **CRES. B** piston. On the GeniSys™ display, the green CRES B indicator will illuminate below the expression bar graphs. Press the **Tutti** piston of your choice. The red Tutti indicator will display to indicate which Tutti is active.

## D. MIDI FUNCTIONS

This section explains the MIDI capabilities of the Allen Organ. Knowledge of this section is **not** required for everyday use of the organ, normal service playing, or use of Allen SmartMIDI™ devices. This information's usefulness will ultimately be determined by your needs, along with the type and capabilities of any external MIDI devices you choose to use--e.g., sequencers, voice/sound modules and external MIDI keyboards. The MIDI topics covered by this manual are limited in scope. A basic understanding of the terms MIDI IN, OUT and THRU and their basic functions are required. To increase your understanding of MIDI and its capabilities it is suggested that books or literature be referenced which describe how to use MIDI.

**Note:** Please consult the owner's manual of the external MIDI device(s) being used for more details of their operation.

### 1. Standard MIDI Channel Assignments

These are the Allen Organs' standard MIDI channels settings:

LD-34b		
Channel		Organ Division
1	=	Swell
2	=	Great
3	=	Pedal
8	=	General

**Note:** The MIDI Base Channel always resets to Channel 1 whenever the organ is turned on.

### 2. Selecting Program Change Modes

Program change modes establish how MIDI program changes are sent from the organ when a piston is pressed. Once a particular program change mode is selected, the organ will retain the same program change mode (even when the organ is turned off) until a new program change mode is selected. These three mode options determine how the organ sends program change information to MIDI devices.

#### Selecting a Program Change Mode

To access the Program Change mode function, touch:

*OPTIONS >> MIDI >> PROGRAM CHANGE & DISPLAY OPTIONS*



**Important!** It is important to understand how to operate and when to use each of these modes before they are changed!

#### Program Change Modes:

PRESET Mode: This mode causes the organ to send a program change number equal to the piston number that is pressed. Preset mode also causes the organ to transmit the capture memory level value whenever the capture memory level is changed or whenever the CANCEL piston is pressed. General Pistons will send program changes 1-10 on MIDI Channel 8, the organ's General Piston control channel. The Divisional Pistons for each division will send program changes on the respective MIDI channels as shown above.

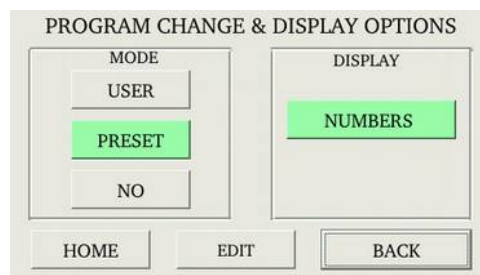



For example, Swell Piston 1 will send Program Change 1 on MIDI Channel 1. Great Piston 2 will send Program Change 2 on MIDI Channel 2, etc.

**USER Mode:** In this mode, the organ is capable of sending any program change number on any piston that will select voices, change banks, or change program “patch” numbers on another MIDI device. Any MIDI program change number from 1 through 128 can be assigned to any General or Divisional Piston (blank or no digit may also be selected). Any MIDI bank switch number between 0 and 127 can be assigned to any Divisional Piston. As in PRESET mode, General Pistons will send program change information on MIDI Channel 8 and Divisional Pistons will send program change information on their respective MIDI channels.

**Note:** The capture memory level value is not transmitted while in USER mode.

**NO Mode:** With this mode selected, NO program change information is either transmitted or received.

### **Display Options: General MIDI Sound Names or Program Numbers**

While in PRESET mode, MIDI program changes will only be displayed as MIDI program change numbers. However, USER mode allows MIDI program changes to be displayed as either MIDI program change numbers or as General MIDI sound names. This flexibility allows for simpler programming, especially if the connected MIDI sound module is General MIDI compatible. Any piston can be programmed to access any General MIDI sound/voice by selecting and assigning the same name to a piston.

#### **General MIDI Sound Names**

When a piston is pressed, the General MIDI sound name will display which corresponds to the MIDI program change selected. Any General MIDI sound name may be selected and assigned to a piston.

**Note:** In some cases, the General MIDI sound name may be abbreviated.

#### **Program Numbers:**

With NUMBERS selected as the display mode, the corresponding MIDI program change number assigned to a selected piston will be displayed. Any MIDI program change number, 1 through 128, may be selected and assigned to a piston.

### **3. MIDI Bank Selecting**

Many MIDI devices permit access to a variety of sounds in addition to the General MIDI sounds. Normally these additional sounds are stored in groups called BANKS. A BANK in MIDI terminology means a group of voices or sounds.

MIDI devices can have as many as 128 sounds/voices per BANK Number. There can also be 128 available BANK Numbers (0 through 127). With 128 BANK Numbers, each Bank could contain up to 128 voices/sounds, for a total of 16,384 sounds. For an easier explanation, think of the BANK Numbers as floors or stories in a tall building. Each floor would contain 128 rooms and each room could then contain 128 voices.

There are also those MIDI devices which can have both LOW bank and HIGH bank memory sections. This ability can then increase the number of available voices substantially. Imagine, 128 LOW and HIGH Banks with each Bank containing a possible 128 voices. That’s a total of 32,768 possible voices!

Fortunately, most MIDI devices do not use all of the available locations as it would be very expensive as well as very difficult to remember the address for each sound location. With the added flexibility of Bank control along with the ability to program any MIDI program change number to any piston, Allen Organs are able communicate with all MIDI devices.

**Note:** You MUST know the capabilities of, and understand how to operate, the MIDI device you intend to use with the organ!

#### 4. Assigning MIDI Program Changes to Pistons

While the Program Change & Display Options function is displayed, first make sure USER mode is selected and then touch the EDIT button to program and assign MIDI program changes to pistons.

Once in edit mode, pressing a piston will display the MIDI program change specifics for that piston. The piston pressed, Bank and MIDI program change information will be displayed.

To change the Bank number, touch the BANK button to highlight it, then use the UP and DOWN buttons to change the bank value.

To change the MIDI program change value, touch the PROGRAM button to highlight it, then use the UP and DOWN buttons to change the program value (or General MIDI name).

To change the MIDI program change settings on another piston, simply press that piston and the display will change to display the selected piston's MIDI program change settings.

**Note:** MIDI program change data will remain assigned to the pistons even if the organ has been turned off.

Touch the HOME button to return to the *Home* screen or the BACK button to return to the previous menu screen.

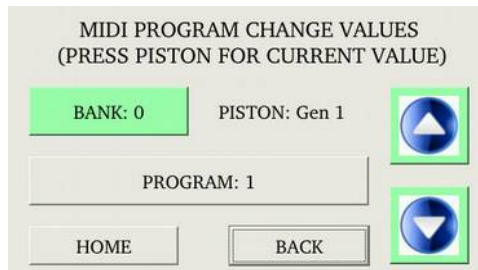
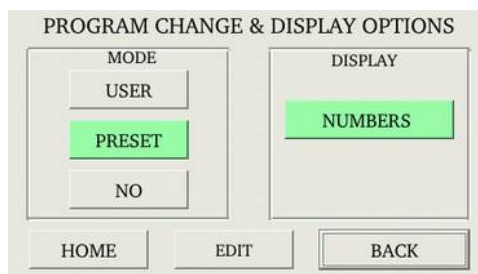

#### 5. MIDI Base Channel

The MIDI Base Channel is a reference point to establish the positioning of the other 15 MIDI channels on the organ. On Allen Organs, the Base Channel equals the Swell Division's channel of transmission (i.e., if the Base Channel = 1, then the Swell Channel = 1, if the Base Channel = 2, then the Swell Channel = 2, etc.). Moving the Base Channel allows you to shift the organ's range of MIDI channels, this can be helpful when reassigning an external MIDI device from one organ division to another.



**Important!** The Base Channel always resets to MIDI Channel 1 whenever the organ is turned on.

To access the MIDI Base Channel function, touch:  
*OPTIONS >> MIDI >> MIDI BASE CHANNEL*

To change the MIDI Base Channel, touch the CHANNEL button to highlight it, then use the UP and DOWN buttons to change the MIDI channel value.

Remember, if the Base Channel is set to 2, all of the other MIDI channels will shift higher by one. Now; Swell = 2, Great = 3, Pedal = 4 and the General Pistons = 9.

**Note:** MIDI Channel numbers will wrap, i.e. as MIDI channel numbers only go to 16 and then repeat to 1.

### Selecting High Bank or Low Bank:

To change the Bank value, touch the BANK value button to highlight it, then use the UP and DOWN buttons to change to use either the LOW or HIGH Bank value.

**Note:** Refer to the Bank selection/program number chart in the owner's manual for the external MIDI device you are using to be sure you are using a valid Bank number value.

Touch the HOME button to return to the *Home* screen or the BACK button to return to the previous menu screen.

## 6. MIDI Expression Settings

There are four modes for transmitting expression data via MIDI; Poly Volume, Poly Velocity, Swell Volume and No Expression. To access the MIDI Expression setting, touch:

*OPTIONS >> MIDI >> EXPRESSION*

**Note:** The default expression mode setting is always POLY-VOLUME.

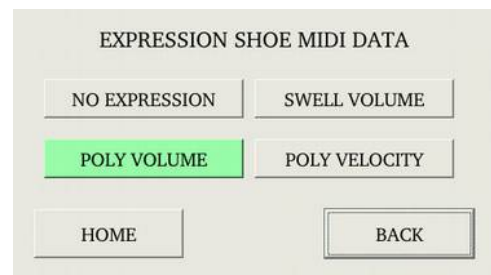

### MIDI Expression Modes:

**POLY-VOLUME** — this is the normal expression mode setting where the expression data is distributed among the appropriate MIDI channels.

**POLY-VELOCITY** — this setting should be selected if you are using a percussion-type voice from a sound module or an external MIDI keyboard. For example, if a digital piano sound were played from the organ keyboard through MIDI Channel 1, the piano could be made to sound more realistic. By opening the Swell expression shoe, the piano strings would appear to be struck harder than when the Swell pedal was in the closed position.



**Important!** This mode setting should only be used if the organ does not contain velocity sensitive keying.

**Note:** In POLY-VELOCITY mode, all expression information is sent in key velocity form. Changes in velocity will occur only when a new key is struck. Consequently, if you change the position of the expression pedal after a key is struck there will be no change in velocity until a new key is struck. Use this mode only when a velocity-sensitive external MIDI device is connected. If this mode is selected when recording to a sequencer, the expression on the organ will not function when playing back from the sequencer.

**SWELL-VOLUME** — this mode setting causes MIDI expression data to be sent only on the Swell MIDI channel. Some early sequencers can only interpret one volume message.

**NO EXPRESSION** — No MIDI expression (volume) data sent.

Touch the HOME button to return to the *Home* screen or the BACK button to return to the previous menu screen.

## 7. MIDI Sustain Kick Switch (optional)

A lever located to the left of the expression shoe and controlled by the organist's foot, operates MIDI sustain. This function can be assigned to any one of or all of the instrument's manuals.

To access the MIDI Sustain selection display, touch:

**OPTIONS >> MIDI >> SUSTAIN**

Touch the associated manual's button to change the on or off status. The function will "toggle" each time the button is touched. If a manual button is highlighted, the Sustain function is "on". If a manual button is not highlighted, the Sustain function is "off".

**OFF** will not allow MIDI Sustain messages to be transmitted, **ON** will allow MIDI sustain messages to be transmitted on a given keyboard (manual) or MIDI channel. For example, when a **PIANO** voice in an external MIDI device (voice module) is selected and the MIDI sustain for that given MIDI channel (division) is turned **ON**, and the foot controlled sustain lever is actuated, the piano sound will slowly decay.

Touch the HOME button to return to the *Home* screen or the BACK button to return to the previous menu screen.

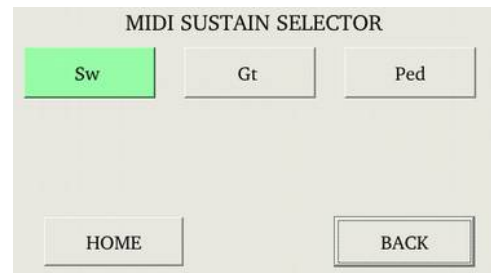

## 8. Organ Local Off

Organ Local Off is a function that will "virtually" disconnect the organ's keyboards, pedalboard and pistons from the organ's tone generation and capture system. In essence, the organ is transformed into a sophisticated multi-manual MIDI controller.

To access the Organ Local Off function, touch:

**OPTIONS >> MIDI >> ORGAN LOCAL OFF**

To **enable** the Organ Local Off function, touch the ENABLE button to highlight it.

To **disable** the Organ Local Off function, touch the DISABLED button to highlight it.

**Note:** When Organ Local Off is enabled, the MIDI stops do not need to be turned on to play the external MIDI device(s).

Touch the HOME button to return to the *Home* screen or the BACK button to return to the previous menu screen.

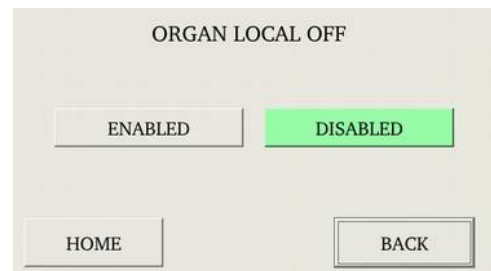

## 10. Transmission/Reception of Individual Stop Data

This function allows the organist to turn on/off the transmission and reception of individual stop data, known in MIDI terminology as "Non-Registered Parameters". In some cases individual stop data (on/off) from the organ may conflict with data from an external MIDI device. When this occurs, select "OFF".

**Note:** Piston changes will still be transmitted and received, because they are MIDI program changes.

**Note:** This function always defaults to "on" whenever the organ is turned on.

To access the Transmit/Receive Stop function, touch:

*OPTIONS >> MIDI >> TRANSMIT/RECEIVE*

To change the on/off status of the Transmit/Receive Stops function, touch either the ON or OFF button to highlight it.

Touch the HOME button to return to the *Home* screen or the BACK button to return to the previous menu screen.

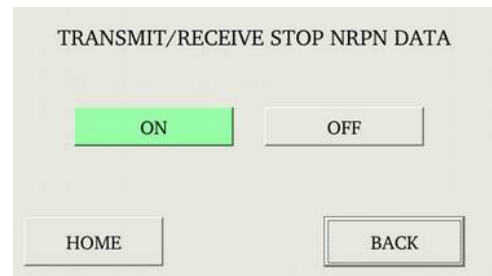

## **E. MIDI GUIDE**

### **1. MIDI for Organists**

The term MIDI is an acronym for Musical Instrument Digital Interface. Since 1983, MIDI has been adopted by the music industry as a standard means of communication between digital musical devices enabling instruments of different types and manufacturers to communicate. MIDI by itself will not make a sound. It is not necessary to understand all of the technical aspects of MIDI in order to take advantage of the benefits it offers. It is important to explore the potential MIDI holds for musicians, as well as the various MIDI applications available today.

#### **Types of MIDI Devices**

MIDI devices fall into two categories.

- ❑ The first category consists of musical instruments such as organs and synthesizers that transmit and receive MIDI data.
- ❑ The second category includes controllers and processors that, as their name implies, can transmit, receive or manipulate MIDI data, but do not necessarily produce sound themselves. Sequencers, which are MIDI recording devices, fall into this category. Although the technical nature of their recording and editing processes differs from those of a tape recorder, many operate in similar fashion. Most are equipped with record, playback, fast forward and reverse controls that function in the same way as their tape recorder counterparts.

#### **Types of MIDI Data**

There are several types of MIDI messages that can be sent from one device to another. The most common is keying information, allowing one device to sense which keys have been played on another device. This means an organ equipped with MIDI can send information to other MIDI devices, e.g., synthesizers or sequencers, and can play those devices simultaneously or record information to be played back later.

Allen Organs incorporate an advanced MIDI system allowing the transmission and reception of all types of MIDI information (velocity keying, volume, sustain, registrations and much more). It is even possible to control several devices from one manual simultaneously, or control a different device from each manual of the console.

#### **MIDI as a Practice Tool**

For the organist/choir director, the MIDI organ console and sequencer are valuable rehearsal tools for both choral and organ works. Anthem accompaniments may be recorded in advance and played back by the sequencer during choir rehearsal. The director, freed from the role of accompanist, can focus entirely on directing the choir. The sequencer can play the music back at a slower tempo without affecting pitch or at a lower pitch without affecting tempo, features that are useful in rehearsing difficult choral passages.

If the sequencer allows multi-tracking, each vocal section's part may be recorded on a different track, and then played back individually, or in any combination, for more flexibility. Multi-tracking can also be used in teaching and learning new organ works. The teacher may record each hand or pedal part on a different track, allowing the student to "mute" or turn off any part being practiced while still being able to hear the sequencer play the rest of the composition. The student's ability to hear the piece in its entirety from the earliest stage of learning a composition, and to become aware of the interrelationship of its voices, is especially valuable in learning contrapuntal works.

### **MIDI as a Registration Tool**

In some churches and auditoriums it is difficult to judge the effectiveness of a registration from the organ console. Due to the acoustics of the room, or positioning of the console, the sound of the instrument may be different when listened to from the congregation's or audience's vantage point. MIDI allows the organist to evaluate registrations by recording the music using a sequencer, and then listening from different locations in the room during the music's playback.

### **Other MIDI Uses**

MIDI has created new possibilities for the organist. The ability of the organ console to control external keyboards or sound modules puts an ever-increasing array of non-traditional sounds at the organist's fingertips. A superior degree of control is made possible by the flexibility of an organ console. The ability to record MIDI data using a sequencer opens a variety of new possibilities during practice and performance situations.

Computer software programs are also available that allow musicians to play MIDI devices connected to a computer, and have their performance printed as conventional five-line musical notation. Because MIDI is an industry-wide standard, today's MIDI instruments will be compatible with tomorrow's MIDI innovations.

## **2. Allen's Exclusive MIDI System**

Allen Organs feature an advanced MIDI system with increased flexibility. This system provides a comprehensive interface between MIDI sound modules, such as the Allen Ensemble™, and digital sequencers such as the Allen MIDI Assistant™. Two MIDI Out ports, one switched and one unswitched, allow unprecedented control over external MIDI devices attached to the organ.

Under normal circumstances, MIDI sound modules should be connected to the switched MIDI port, labeled MIDI OUT 2. Doing so allows the organist to disable the sending of MIDI keying data from the organ to the sound module. Devices such as MIDI sequencers should be connected to the unswitched MIDI port, labeled MIDI OUT 1, eliminating the necessity of having to draw the MIDI stop controls before recording a digital sequence. The drawing below illustrates the proper procedure for connecting the Allen Ensemble™ and Allen MIDI Assistant™ to an Allen Organ.

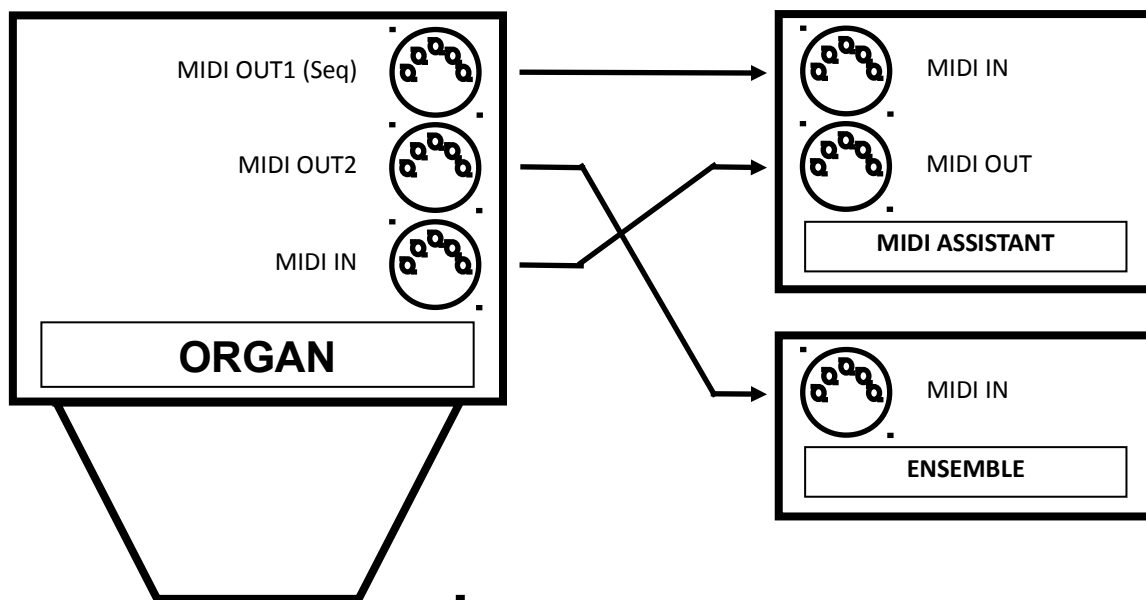

3. **MIDI Transmission Channels** MIDI information may be transmitted on several different channels simultaneously. This allows many channels of information to be sent through one cable and used independently from one another, similar to the way many television broadcasts can be sent through one cable. In order to receive the intended information, a MIDI device must be tuned to the same channel as the device that is sending the information.

Your Allen Organ transmits MIDI information on multiple channels. When external MIDI devices are connected to the organ, it is important to make sure that the devices' channels of transmission and reception match the MIDI channels of the Allen Organ divisions to which they are assigned.

MIDI Program Change Messages are transmitted from the organ's General Pistons on MIDI Channel 8. These program change messages can be used to change the settings of MIDI sound modules or synthesizers that are connected to the organ. Please consult the owner's manual of your MIDI device(s) for more information on how MIDI Program Change Messages are handled by that particular device.

In addition to keying and divisional registration information, MIDI Volume Messages are sent on the individual MIDI channels for each division of the organ. These volume messages are controlled by the expression shoe. In this manner, the volume of connected MIDI devices may be controlled.

Please consult the owner's manual of your MIDI device(s) for more information on how MIDI Volume information is handled by that device. If any external MIDI device is used to transmit information to the Allen organ, the same assignment of MIDI channels must be used as described elsewhere in this manual.



#### 4. General MIDI Sound List

- |                             |                            |                           |
|-----------------------------|----------------------------|---------------------------|
| 1. Acoustic Grand Piano     | 44. Contrabass             | 86. Lead 6 (voice)        |
| 2. Bright Acoustic Piano    | 45. Tremolo Strings        | 87. Lead 7 (fifths)       |
| 3. Electric Grand Piano     | 46. Pizzicato Strings      | 88. Lead 8 (brass + lead) |
| 4. Honky-tonk Piano         | 47. Orchestral Harp        | 89. Pad 1 (new age)       |
| 5. Rhodes Piano             | 48. Timpani                | 90. Pad 2 (warm)          |
| 6. Chorused Piano           | 49. String Ensemble 1      | 91. Pad 3 (polysynth)     |
| 7. Harpsichord              | 50. String Ensemble 2      | 92. Pad 4 (choir)         |
| 8. Clavinet                 | 51. Synth Strings 1        | 93. Pad 5 (bowed)         |
| 9. Celesta                  | 52. Synth Strings 2        | 94. Pad 6 (metallic)      |
| 10. Glockenspiel            | 53. Choir Aahs             | 95. Pad 7 (halo)          |
| 11. Music Box               | 54. Voice Oohs             | 96. Pad 8 (sweep)         |
| 12. Vibraphone              | 55. Synth Voice            | 97. FX 1 (rain)           |
| 13. Marimba                 | 56. Orchestra Hit          | 98. FX 2 (soundtrack)     |
| 14. Xylophone               | 57. Trumpet                | 99. FX 3 (crystal)        |
| 15. Tubular Bells           | 58. Trombone               | 100. FX 4 (atmosphere)    |
| 16. Dulcimer                | 59. Tuba                   | 101. FX 5 (brightness)    |
| 17. Hammond Organ           | 60. Muted Trumpet          | 102. FX 6 (goblins)       |
| 18. Percussive Organ        | 61. French Horn            | 103. FX 7 (echoes)        |
| 19. Rock Organ              | 62. Brass Section          | 104. FX 8 (sci-fi)        |
| 20. Church Organ            | 63. Synth Brass 1          | 105. Sitar                |
| 21. Reed Organ              | 64. Synth Brass 2          | 106. Banjo                |
| 22. Accordion               | 65. Soprano Sax            | 107. Shamisen             |
| 23. Harmonica               | 66. Alto Sax               | 108. Koto                 |
| 24. Tango Accordion         | 67. Tenor Sax              | 109. Kalimba              |
| 25. Acoustic Guitar (nylon) | 68. Baritone Sax           | 110. Bagpipe              |
| 26. Acoustic Guitar (steel) | 69. Oboe                   | 111. Fiddle               |
| 27. Electric Guitar (jazz)  | 70. English Horn           | 112. Shanai               |
| 28. Electric Guitar (clean) | 71. Bassoon                | 113. Tinkle Bell          |
| 29. Electric Guitar (muted) | 72. Clarinet               | 114. Agogo                |
| 30. Overdriven Guitar       | 73. Piccolo                | 115. Steel Drums          |
| 31. Distortion Guitar       | 74. Flute                  | 116. Woodblock            |
| 32. Guitar Harmonics        | 75. Recorder               | 117. Taiko Drum           |
| 33. Acoustic Bass           | 76. Pan Flute              | 118. Melodic Tom          |
| 34. Electric Bass (finger)  | 77. Bottle Blow            | 119. Synth Drum           |
| 35. Electric Bass (pick)    | 78. Shakuhachi             | 120. Reverse Cymbal       |
| 36. Fretless Bass           | 79. Whistle                | 121. Guitar Fret Noise    |
| 37. Slap Bass 1             | 80. Ocarina                | 122. Breath Noise         |
| 38. Slap Bass 2             | 81. Lead 1 (square)        | 123. Seashore             |
| 39. Synth Bass 1            | 82. Lead 2 (sawtooth)      | 124. Bird Tweet           |
| 40. Synth Bass 2            | 83. Lead 3 (calliope lead) | 125. Telephone Ring       |
| 41. Violin                  | 84. Lead 4 (chiff lead)    | 126. Helicopter           |
| 42. Viola                   | 85. Lead 5 (charang)       | 127. Applause             |
| 43. Cello                   |                            | 128. Gunshot              |

## APPENDIX A: MIDI IMPLEMENTATION CHART

FUNCTION		TRANSMITTED	RECEIVED
Basic Channel	Default Changed	1 – 16 1 – 16	1 – 16 1 – 16
Mode	Default Messages Altered	3 X X	3 X X
Note Number		O (1 – 127)	O (1 – 127)
Velocity	Note ON Note OFF	9nH, v = 1 – 127 9nH, v = 0	9nH, v = 1 – 127 9nH, v = 0
Aftertouch	Keys Channels	X X	X X
Pitch Bend		O	O
Control Change	0 (bank select) 6 (Data MSB) 7 (volume) 64 (sustain) 66 (sostenuto) 98 (NRPN: LSB) 99 (NRPN: MSB)	O O O O O O O	X O O O O O O
Program Change		O (1 – 127)	O (1 – 127)
System Exclusive		O	O
System Common		X	X
System Real Time		X	X
Aux Messages		X	X

Mode 1: Omni On, Poly  
Mode 3: Omni Off, Poly

Mode 2: Omni On, Mono  
Mode 4: Omni Off, Mono

O: Yes  
X: No

# APPENDIX B: VISUAL KEY RANGE CHART

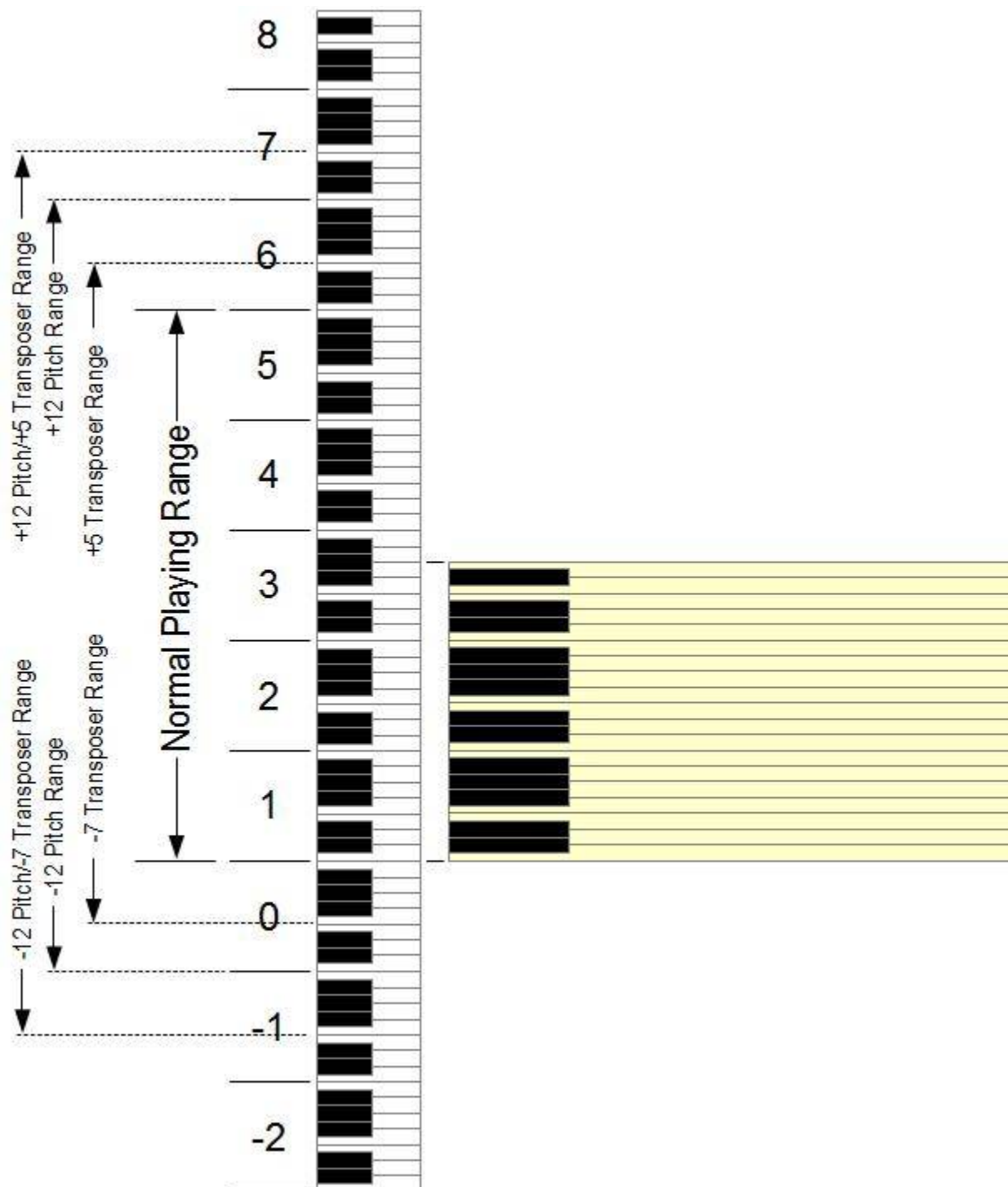

## APPENDIX C: LDS Hymn Player List

GeniSys™ Controller	Full Title	GeniSys™ Controller	Full Title
68 MightyFortress	A Mighty Fortress Is Our God	306 GodsDailyCare	God's Daily Care
29 PoorManGrief	A Poor Wayfaring Man of Grief	83 GuideUsJehovah	Guide Us, O Thou Great Jehovah
166 AbidewithMe	Abide with Me!	209 HarkAngelsSng	Hark! The Herald Angels Sing
165 AbidewithMeEv	Abide with Me; 'Tis Eventide	264 HarkYeNations	Hark, All Ye Nations!
62 AllCreatureGod	All Creatures of Our God and King	223 HaveDoneGood	Have I Done Any Good?
69 AllGloryLaud	All Glory, Laud, and Honor	199 HeIsRisen	He Is Risen!
13 AngelfromHigh	An Angel from on High	281 TeachInspirat	Help Me Teach with Inspiration
203 AngelsonHigh	Angels We Have Heard on High	5 HighMountTop	High on the Mountain Top
277 ISearchScript	As I Search the Holy Scriptures	298 HomeBeHeaven	Home Can Be a Heaven on Earth
309 AsSistersZion	As Sisters in Zion (Women)	85 FirmFoundation	How Firm a Foundation
149 HeavenDistill	As the Dew from Heaven Distilling	125 GentleCommand	How Gentle God's Commands
259 ZionLatterDay	As Zion's Youth in Latter Days	195 GrtWisdomLove	How Great the Wisdom and the Love
8 AwakeandArise	Awake and Arise	86 HowGreatArt	How Great Thou Art
17 AwakeYeSaints	Awake, Ye Saints of God, Awake!	267 HowWondrousGt	How Wondrous and Great
206 AwayinaManger	Away in a Manger	301 ChildofGod	I Am a Child of God
130 BeThouHumble	Be Thou Humble	134 BelieveChrist	I Believe in Christ
219 BeenGivenMuch	Because I Have Been Given Much	214 BellsXmasDay	I Heard the Bells on Christmas Day
191 GtRedeemerDie	Behold the Great Redeemer Die	302 MyFatherLives	I Know My Father Lives
251 BhldRoyalArmy	Behold! A Royal Army	136 IKnowMyRedemr	I Know That My Redeemer Lives
249 CalledtoServe	Called to Serve	98 INeedTheeHour	I Need Thee Every Hour
255 CarryOn	Carry On	15 ISawAngelFly	I Saw a Mighty Angel Fly
299 ChildrenHeavn	Children of Our Heavenly Father	193 StndAllAmazed	I Stand All Amazed
239 ChooseRight	Choose the Right	270 GoWhereWantGo	I'll Go Where You Want Me to Go
200 LrdRisenToday	Christ the Lord Is Risen Today	226 ImproveMoment	Improve the Shining Moments
117 ComeUntoJesus	Come unto Jesus	172 HumiltySavior	In Humility, Our Savior
322 ComeYeSonsGod	Come, All Ye Sons of God (Men)	190 MemryCrucifyd	In Memory of the Crucified
30 ComeYeSaints	Come, Come, Ye Saints	307 LovelyDeseret	In Our Lovely Deseret
116 ComeFollowMe	Come, Follow Me	7 IsraelGodCallng	Israel, Israel, God Is Calling
21 ProphetVoice	<u>Come, Listen to a Prophet's Voice</u>	207 MidnightClear	It Came upon the Midnight Clear
59 ComeThouKing	Come, O Thou King of Kings	269 JehovahEarth	Jehovah, Lord of Heaven and Earth
9 ComeRejoice	Come, Rejoice	181 JesusNazareth	Jesus of Nazareth, Savior and King
10 ComeSingLord	Come, Sing to the Lord	102 JesusLvrSoul	Jesus, Lover of My Soul
50 ThouDayPromise	Come, Thou Glorious Day of Promise	196 JesusHblBirth	Jesus, Once of Humble Birth
119 ComeLoveLord	Come, We That Love the Lord	141 JesusThought	Jesus, the Very Thought of Thee
58 ChildrenofLord	Come, Ye Children of the Lord	26 JSFirstPrayer	Joseph Smith's First Prayer
94 ComeYeThankful	Come, Ye Thankful People	201 JoytotheWorld	Joy to the World
241 CountBlessing	Count Your Blessings	303 KeepComandmnt	Keep the Commandments

GeniSys™ Controller	Full Title	GeniSys™ Controller	Full Title
221 HeartShepherd	Dear to the Heart of the Shepherd	97 LeadKindLight	Lead, Kindly Light
96 DearestChildrn	Dearest Children, God Is Near You	143 LetHolySpirit	Let the Holy Spirit Guide
140 ThinktoPray	Did You Think to Pray?	243 LetAllPressOn	Let Us All Press On
237 DoWhatIsRight	Do What Is Right	232 LetSpeakKind	Let Us Oft Speak Kind Words
293 EachLifeTouch	Each Life That Touches Ours for Good	163 LordDismissUs	Lord, Dismiss Us with Thy Blessing
300 FamilyForever	Families Can Be Together Forever	220 LordFolloThee	Lord, I Would Follow Thee
212 OnJudeaPlains	Far, Far Away on Judea's Plains	153 AskEreWePart	Lord, We Ask Thee Ere We Part
133 FathernHeaven	Father in Heaven	294 LoveatHome	Love at Home
92 ForBeautyEarth	For the Beauty of the Earth	308 LoveOneAnothr	Love One Another
35 StrengthHills	For the Strength of the Hills	105 TempestRaging	Master, the Tempest Is Raging
146 RaiseSacStran	Gently Raise the Sacred Strain	131 MoreHoliness	More Holiness Give Me
67 GlorytoGodHigh	Glory to God on High	135 RedeemerLives	My Redeemer Lives
263 GoForthFaith	Go Forth with Faith	100 NearerMyGod	Nearer, My God, to Thee
152 WeMeetAgain	God Be with You Till We Meet Again	3 NowLetUsRejoice	Now Let Us Rejoice
24 BlessProphet	God Bless Our Prophet Dear	159 NowDayIsOver	Now the Day Is Over
87 GodsLove	God Is Love	25 NowSingAccord	Now We'll Sing with One Accord
187 GodLovedSent	God Loved Us, So He Sent His Son	31 HelpinAgesPast	O God, Our Help in Ages Past
78 GodFathersHand	God of Our Fathers, Whose Almighty Hand	175 EternalFather	O God, the Eternal Father
20 GodPowerRight	God of Power, God of Right	208 TownBethlehem	O Little Town of Bethlehem
170 GodHearUsPray	God, Our Father, Hear Us Pray	295 LoveGlorifies	O Love That Glorifies the Son
292 OMyFather	O My Father	1 MorningBreaks	The Morning Breaks
150 GraciousFathr	O Thou Kind and Gracious Father	2 SpiritofGod	The Spirit of God
272 OhWhatIsTruth	Oh Say, What Is Truth?	266 TimeFarSpent	The Time Is Far Spent
202 ComeFaithful	Oh, Come, All Ye Faithful	18 VoiceGodHeard	The Voice of God Again Is Heard
246 OnwardSoldier	Onward, Christian Soldiers	194 GreenHillAway	There Is a Green Hill Far Away
113 OurSaviorLove	Our Savior's Love	227 SunshineSoul	There Is Sunshine in My Soul Today
242 PraseBlessing	Praise God, from Whom All Blessings Flow	122 DeepningTrial	Though Deepening Trials
27 PraisetotheMan	Praise to the Man	157 SpiritStrSoul	Thy Spirit, Lord, Has Stirred Our Souls
145 PrayerDesire	Prayer Is the Soul's Sincere Desire	229 TodaySunShine	Today, While the Sun Shines
93 PrayerThanxgvg	Prayer of Thanksgiving	254 TruetoFaith	True to the Faith
81 PressForwardSt	Press Forward, Saints	4 TruthEternal	Truth Eternal
252 ShoulderWheel	Put Your Shoulder to the Wheel	273 TruthReflects	Truth Reflects upon Our Senses
6 RedeemerIsrael	Redeemer of Israel	291 TurnYourHeart	Turn Your Hearts
66 RejoiceIsKing	Rejoice, the Lord Is King!	12 WitnessMornSky	Tw'as Witnessed in the Morning Sky
287 TemplesEnter	Rise, Ye Saints, and Temples Enter	184 CrossCalvary	Upon the Cross of Calvary
28 BeholdJehovah	Saints, Behold How Great Jehovah	250 WeAllEnlisted	We Are All Enlisted
230 ScatrSunshine	Scatter Sunshine	225 MarchingGlory	We Are Marching On to Glory
144 SecretPrayer	Secret Prayer	216 WeAreSowing	We Are Sowing
204 SilentNight	Silent Night	23 WePrayforThee	We Ever Pray for Thee
156 SingWeNowPart	Sing We Now at Parting	22 WeListenVoice	We Listen to a Prophet's Voice
160 NowLightofDay	Softly Now the Light of Day	19 ThankGodPropht	We Thank Thee, O God, for A Prophet

<b>GeniSys™ Controller</b>	<b>Full Title</b>	<b>GeniSys™ Controller</b>	<b>Full Title</b>
142 SwtHourPrayer	Sweet Hour of Prayer	280 SabbathMorn	Welcome, Welcome, Sabbath Morning
14 SweetPeaceGosp	Sweet Is the Peace the Gospel Brings	182 SingHailJesus	We'll Sing All Hail to Jesus' Name
147 SweetIsWork	Sweet Is the Work	16 GloriousScenes	What Glorious Scenes Mine Eyes Behold
304 TeachMetoWalk	Teach Me to Walk in the Light	11 WitnessHeavens	What Was Witnessed in the Heavens?
137 Testimony	Testimony	128 FaithEndures	When Faith Endures
52 DawnIsBreaking	The Day Dawn Is Breaking	129 ITurnforPeace	Where Can I Turn for Peace?
213TheFirstNoel	The First Noel	174 EmblemPartake	While of These Emblems We Partake
274 TheIronRod	The Iron Rod	210 WonderingAwe	With Wondering Awe
305 TheLightDvine	The Light Divine	319 YeElderIsrael	Ye Elders of Israel (Men)
89 LordIsMyLight	The Lord Is My Light	321 YeCalltoLabor	Ye Who Are Called to Labor (Men)
108 LordIsShephrd	The Lord Is My Shepherd	228 PathwayBright	You Can Make the Pathway Bright

Specifications subject to change without notice or obligation.

Copyright © 2016, Allen Organ Company LLC, All Rights Reserved

## APPENDIX D: GNU PUBLIC LICENSE INFORMATION

### NOTICE:

Portions (but not all) of the software contained within this device are covered by the GNU General Public License shown below. As Such, for a period of three years after the manufacture date, you are entitled to a machine-readable copy of the applicable source code for a fee that covers the distribution costs. You may request a copy by sending that request in writing to:

GENISYS GPL REQUEST  
ALLEN ORGAN COMPANY LLC  
150 LOCUST ST.  
MACUNGIE, PA 18062

Please include your name, address, and phone number.

All portions not covered by the GNU GPL are to be considered Copyright (C) 2008, Allen Organ Company LLC, all rights reserved.

GNU GENERAL PUBLIC LICENSE  
Version 2, June 1991  
Copyright (C) 1989, 1991 Free Software Foundation, Inc.  
51 Franklin St, Fifth Floor, Boston, MA 02110-1301 USA

Everyone is permitted to copy and distribute verbatim copies of this license document, but changing it is not allowed.

### PREAMBLE

The licenses for most software are designed to take away your freedom to share and change it. By contrast, the GNU General Public License is intended to guarantee your freedom to share and change free software--to make sure the software is free for all its users. This General Public License applies to most of the Free Software Foundation's software and to any other program whose authors commit to using it. (Some other Free Software Foundation software is covered by the GNU Library General Public License instead.) You can apply it to your programs, too. When we speak of free software, we are referring to freedom, not price. Our General Public Licenses are designed to make sure that you have the freedom to distribute copies of free software (and charge for this service if you wish), that you receive source code or can get it if you want it, that you can change the software or use pieces of it in new free programs; and that you know you can do these things. To protect your rights, we need to make restrictions that forbid anyone to deny you these rights or to ask you to surrender the rights. These restrictions translate to certain responsibilities for you if you distribute copies of the software, or if you modify it. For example, if you distribute copies of such a program, whether gratis or for a fee, you must give the recipients all the rights that you have. You must make sure that they, too, receive or can get the source code. And you must show them these terms so they know their rights. We protect your rights with two steps: (1) copyright the software, and (2) offer you this license which gives you legal permission to copy, distribute and/or modify the software. Also, for each author's protection and ours, we want to make certain that everyone understands that there is no warranty for this free software. If the software is modified by someone else and passed on, we want its recipients to know that what they have is not the original, so that any problems introduced by others will not reflect on the original authors' reputations. Finally, any free program is threatened constantly by software patents. We wish to avoid the danger that redistributors of a free program will individually obtain patent licenses, in effect making the program proprietary. To prevent this, we have made it clear that any patent must be licensed for everyone's free use or not licensed at all. The precise terms and conditions for copying, distribution and modification follow.

## GNU GENERAL PUBLIC LICENSE

### TERMS AND CONDITIONS FOR COPYING, DISTRIBUTION AND MODIFICATION

- This License applies to any program or other work which contains a notice placed by the copyright holder saying it may be distributed under the terms of this General Public License. The "Program", below, refers to any such program or work, and a "work based on the Program" means either the Program or any derivative work under copyright law: that is to say, a work containing the Program or a portion of it, either verbatim or with modifications and/or translated into another language. (Hereinafter, translation is included without limitation in the term "modification".) Each licensee is addressed as "you". Activities other than copying, distribution and modification are not covered by this License; they are outside its scope. The act of running the Program is not restricted, and the output from the Program is covered only if its contents constitute a work based on the Program (independent of having been made by running the Program). Whether that is true depends on what the Program does.
- You may copy and distribute verbatim copies of the Program's source code as you receive it, in any medium, provided that you conspicuously and appropriately publish on each copy an appropriate copyright notice and disclaimer of warranty; keep intact all the notices that refer to this License and to the absence of any warranty; and give any other recipients of the Program a copy of this License along with the Program. You may charge a fee for the physical act of transferring a copy, and you may at your option offer warranty protection in exchange for a fee.
- You may modify your copy or copies of the Program or any portion of it, thus forming a work based on the Program, and copy and distribute such modifications or work under the terms of Section 1 above, provided that you also meet all of these conditions:
  - a. You must cause the modified files to carry prominent notices stating that you changed the files and the date of any change.
  - b. You must cause any work that you distribute or publish, that in whole or in part contains or is derived from the Program or any part thereof, to be licensed as a whole at no charge to all third parties under the terms of this License.
  - c. If the modified program normally reads commands interactively when run, you must cause it, when started running for such interactive use in the most ordinary way, to print or display an announcement including an appropriate copyright notice and a notice that there is no warranty (or else, saying that you provide a warranty) and that users may redistribute the program under these conditions, and telling the user how to view a copy of this License. (Exception: if the Program itself is interactive but does not normally print such an announcement, your work based on the Program is not required to print an announcement.) These requirements apply to the modified work as a whole. If identifiable sections of that work are not derived from the Program, and can be reasonably considered independent and separate works in themselves, then this License, and its terms, do not apply to those sections when you distribute them as separate works. But when you distribute the same sections as part of a whole which is a work based on the Program, the distribution of the whole must be on the terms of this License, whose permissions for other licensees extend to the entire whole, and thus to each and every part regardless of who wrote it. Thus, it is not the intent of this section to claim rights or contest your rights to work written entirely by you; rather, the intent is to exercise the right to control the distribution of derivative or collective works based on the Program. In addition, mere aggregation of another work not based on the Program with the Program (or with a work based on the Program) on a volume of a storage or distribution medium does not bring the other work under the scope of this License.
- You may copy and distribute the Program (or a work based on it, under Section 2) in object code or executable form under the terms of Sections 1 and 2 above provided that you also do one of the following:
  - a. Accompany it with the complete corresponding machine-readable source code, which must be distributed under the terms of Sections 1 and 2 above on a medium customarily used for software interchange; or,
  - b. Accompany it with a written offer, valid for at least three years, to give any third party, for a charge no more than your cost of physically performing source distribution, a complete machine-readable copy of the corresponding source code, to be distributed under the terms of Sections 1 and 2 above on a medium customarily used for software interchange; or,



- c. Accompany it with the information you received as to the offer to distribute corresponding source code. (This alternative is allowed only for noncommercial distribution and only if you received the program in object code or executable form with such an offer, in accord with Subsection b above.) The source code for a work means the preferred form of the work for making modifications to it. For an executable work, complete source code means all the source code for all modules it contains, plus any associated interface definition files, plus the scripts used to control compilation and installation of the executable. However, as a special exception, the source code distributed need not include anything that is normally distributed (in either source or binary form) with the major components (compiler, kernel, and so on) of the operating system on which the executable runs, unless that component itself accompanies the executable. If distribution of executable or object code is made by offering access to copy from a designated place, then offering equivalent access to copy the source code from the same place counts as distribution of the source code, even though third parties are not compelled to copy the source along with the object code.
- You may not copy, modify, sub-license, or distribute the Program except as expressly provided under this License. Any attempt otherwise to copy, modify, sub-license or distribute the Program is void, and will automatically terminate your rights under this License. However, parties who have received copies, or rights, from you under this License will not have their licenses terminated so long as such parties remain in full compliance.
  - You are not required to accept this License, since you have not signed it. However, nothing else grants you permission to modify or distribute the Program or its derivative works. These actions are prohibited by law if you do not accept this License. Therefore, by modifying or distributing the Program (or any work based on the Program), you indicate your acceptance of this License to do so, and all its terms and conditions for copying, distributing or modifying the Program or works based on it.
  - Each time you redistribute the Program (or any work based on the Program), the recipient automatically receives a license from the original licensor to copy, distribute or modify the Program subject to these terms and conditions. You may not impose any further restrictions on the recipients' exercise of the rights granted herein. You are not responsible for enforcing compliance by third parties to this License.
  - If, as a consequence of a court judgment or allegation of patent infringement or for any other reason (not limited to patent issues), conditions are imposed on you (whether by court order, agreement or otherwise) that contradict the conditions of this License, they do not excuse you from the conditions of this License. If you cannot distribute so as to satisfy simultaneously your obligations under this License and any other pertinent obligations, then as a consequence you may not distribute the Program at all. For example, if a patent license would not permit royalty-free redistribution of the Program by all those who receive copies directly or indirectly through you, then the only way you could satisfy both it and this License would be to refrain entirely from distribution of the Program. If any portion of this section is held invalid or unenforceable under any particular circumstance, the balance of the section is intended to apply and the section as a whole is intended to apply in other circumstances. It is not the purpose of this section to induce you to infringe any patents or other property right claims or to contest validity of any such claims; this section has the sole purpose of protecting the integrity of the free software distribution system, which is implemented by public license practices. Many people have made generous contributions to the wide range of software distributed through that system in reliance on consistent application of that system; it is up to the author/donor to decide if he or she is willing to distribute software through any other system and a licensee cannot impose that choice. This section is intended to make thoroughly clear what is believed to be a consequence of the rest of this License.
  - If the distribution and/or use of the Program is restricted in certain countries either by patents or by copyrighted interfaces, the original copyright holder who places the Program under this License may add an explicit geographical distribution limitation excluding those countries, so that distribution is permitted only in or among countries not thus excluded. In such case, this License incorporates the limitation as if written in the body of this License.
  - The Free Software Foundation may publish revised and/or new versions of the General Public License from time to time. Such new versions will be similar in spirit to the present version, but may differ in detail to address new problems or concerns. Each version is given a distinguishing version number. If the Program specifies a version number of this License which applies to it and "any later version", you have the option of following the terms and conditions either of that version or of any later version published by the Free Software Foundation. If the Program does not specify a version number of this License, you may choose any version ever published by the Free Software Foundation.

- If you wish to incorporate parts of the Program into other free programs whose distribution conditions are different, write to the author to ask for permission. For software which is copyrighted by the Free Software Foundation, write to the Free Software Foundation; we sometimes make exceptions for this. Our decision will be guided by the two goals of preserving the free status of all derivatives of our free software and of promoting the sharing and reuse of software generally.

#### **NO WARRANTY**

- Because the program is licensed free of charge, there is no warranty for the program, to the extent permitted by applicable law. Except when otherwise stated in writing the copyright holders and/or other parties provide the program "as is" without warranty of any kind, either expressed or implied, including, but not limited to, the implied warranties of merchantability and fitness for a particular purpose. The entire risk as to the quality and performance of the program is with you. Should the program prove defective, you assume the cost of all necessary servicing, repair or correction.
- In no event unless required by applicable law or agreed to in writing will any copyright holder, or any other party who may modify and/or redistribute the program as permitted above, be liable to you for damages, including any general, special, incidental or consequential damages arising out of the use or inability to use the program (including but not limited to loss of data or data being rendered inaccurate or losses sustained by you or third parties or a failure of the program to operate with any other programs), even if such holder or other party has been advised of the possibility of such damages.

End of terms and conditions.