

# **JOHANNUS WM-47 LDS**

## **USER'S GUIDE**

**This manual and additional videos available  
for download at [www.johannus-lds.com](http://www.johannus-lds.com).**

## INTRODUCTION

---

The Johannus WM-47 LDS organ is custom built for The Church of Jesus Christ of Latter-day Saints. It has been designed primarily as an instrument for accompanying congregational singing as well as to provide a variety of tonal color for prelude music.

Recordings of fine pipe organs from around the world are used to create the beautiful sound of this Johannus organ. When a player presses a key, we hear the actual recording of a pipe, not just an imitation of one.

We hope you enjoy using this instrument as much as we enjoy building it. Should you have any comments or questions, please contact your authorized Johannus dealer.

## TABLE OF CONTENTS

---

Overview .....	5
Basic Functions	
Activating Stops .....	7
Piano .....	7
Couplers .....	8
Controlling Volume Level .....	9
Crescendo Pedal.....	10
General and Divisional Pistons.....	11
Preset General Pistons (Memory 1 and 2) .....	12
Bass & Melody Couplers.....	13
Hymn & Prelude Player .....	14
Advanced Functions	
Programming Pistons.....	17
Transposer .....	18
Tuning .....	19
Chorus Tuning .....	19
Stoplists .....	20
Selecting Harp Style .....	20
Tutti.....	21
Programmable MIDI .....	21
Other Menu Items .....	22
Understanding Stops.....	23
Registration Help.....	26
Hymn Player Contents.....	31
Maintenance .....	33
Warranty .....	33
Troubleshooting.....	34
External Connections.....	35
MIDI Implementation Chart.....	36
MIDI Specifications.....	37
WM-47 LDS Specifications.....	39

## SAFETY PRECAUTIONS

---

- ✓ Place the organ on a stable, horizontal surface.
- ✓ Connect the organ to an electrical outlet with a ground connection.
- ✓ Switch the organ off when it is not in use.
- ✓ Do not place the organ in a damp area.
- ✓ Do not expose the organ to liquids.
- ✓ Follow the instructions and precautionary measures in this user manual.
- ✓ Keep this user manual with the organ.
- ✓ The organ may only be opened by a technician authorized by Johannes Orgelbouw b.v. The organ contains static-sensitive components. The warranty becomes null and void if the organ is opened by a non-authorized person.

## SYMBOLS IN THIS MANUAL

---



Warning or important information.



Note.

## **MANUFACTURER**

---

Johannus Orgelbouw b.v.  
Keplerlaan 2  
6716 BS EDE  
The Netherlands

Telephone: +31 (0)318 63 74 03  
Fax: +31 (0)318 62 22 38  
E-mail: [inform@johannus.com](mailto:inform@johannus.com)  
Website: [www.johannus.com](http://www.johannus.com)

## **TECHNICAL ASSISTANCE AND SERVICE**

---

Johannus-LDS Support  
Telephone: 877-564-9644  
E-mail: [help@johannus-lds.com](mailto:help@johannus-lds.com)  
Website: [www.johannus-lds.com](http://www.johannus-lds.com)

## **© 2010 JOHANNUS ORGELBOUW AND JOHANNUS-LDS SUPPORT**

---

All rights reserved. Nothing in this manual may be reproduced, stored in a data file or made public in any form or in any way either electronically, mechanically, by way of photocopying, recording or in any other way without the prior written permission of Johannus Orgelbouw and Johannus-LDS Support.

## OVERVIEW OF MAIN COMPONENTS

---

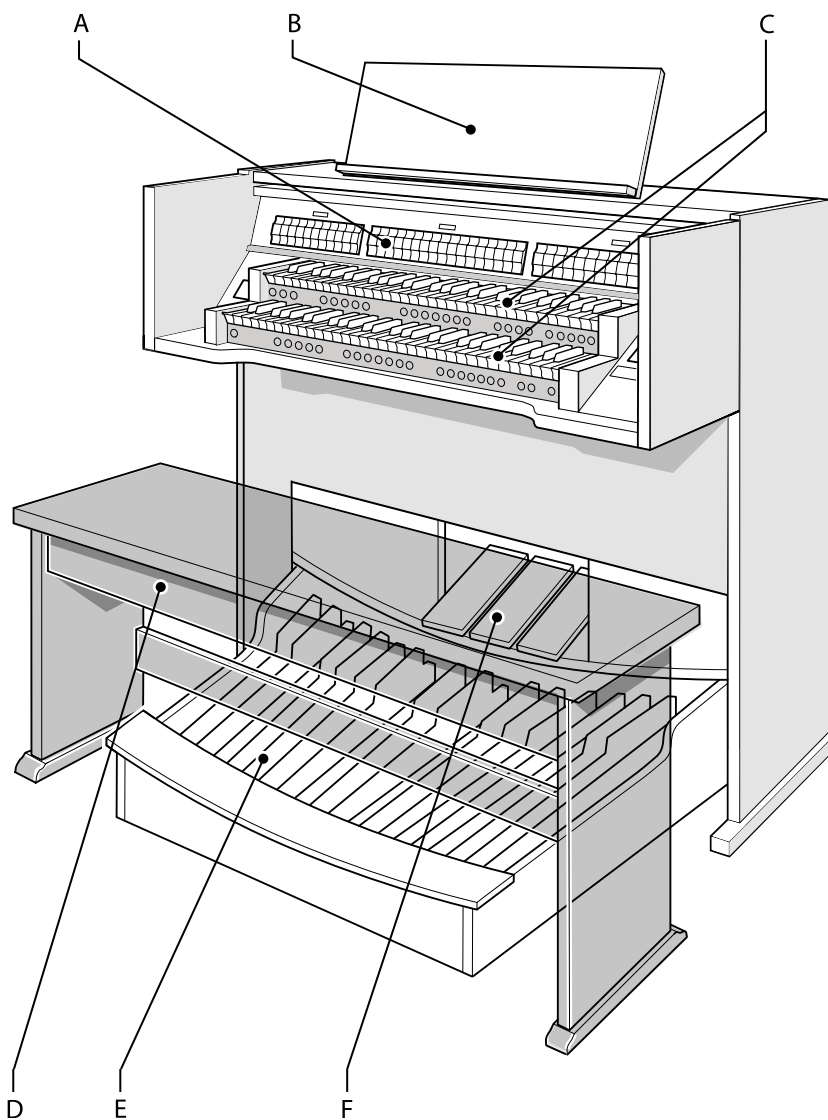

- A Stops
- B Music desk
- C Manuals
- D Bench
- E Pedalboard
- F Expression and Crescendo Shoes

## OVERVIEW OF CONTROLS

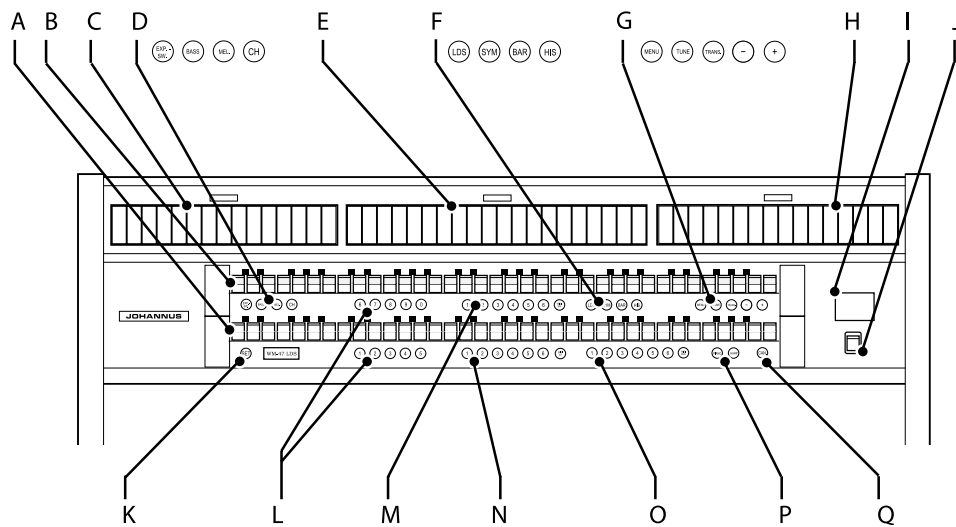

For a detailed description of functions see page number listed next to each feature.

- |                                    |   |
|------------------------------------|---|
| <b>A</b> Great Manual <i>7</i>     | <b>H</b> Great Stops <i>7</i>               |
| <b>B</b> Swell Manual <i>7</i>     | <b>I</b> Display                            |
| <b>C</b> Pedal Stops <i>7</i>      | <b>J</b> Power Switch                       |
| <b>D</b> EXP-SW <i>9</i>           | <b>K</b> SET <i>17</i>                      |
| BASS <i>13</i>                     | <b>L</b> General Pistons <i>11</i>          |
| MEL. <i>13</i>                     | <b>M</b> Great Divisional Pistons <i>11</i> |
| CH <i>19</i>                       | <b>N</b> Swell Divisional Pistons <i>11</i> |
| <b>E</b> Swell Stops <i>7</i>      | <b>O</b> Pedal Divisional Pistons <i>11</i> |
| <b>F</b> Stolist Pistons <i>20</i> | <b>P</b> Piano, Harp <i>7, 20</i>           |
| <b>G</b> MENU <i>14, 22</i>        | <b>Q</b> General CANCEL <i>7</i>            |
| TUNE <i>19</i>                     |   |
| TRANS. <i>18</i>                   |   |
| - / + <i>12</i>                    |   |

## OVERVIEW OF EXPRESSION SHOES

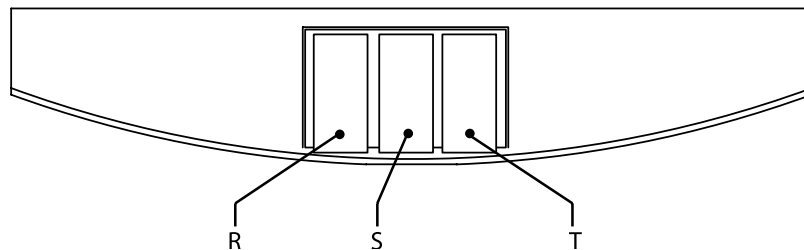

- |  |
|--|
| <b>R</b> Great/Pedal Expression <i>9</i> |
| <b>S</b> Swell Expression <i>9</i>       |
| <b>T</b> General Crescendo <i>10</i>     |

## ACTIVATING STOPS

---

Stops control the voices of the organ and have various names. When a stop is activated you will hear its voice when keys are played. For a more detailed description of each stop and how they can be used, see the section on stops and registration.

Either the top or the bottom of the stop tab may be pressed to turn a stop on or off. When the stop is activated the stop tab lights up.

The stops are grouped into *divisions* related to each of the keyboards and pedalboard. Stops from the Pedal division are heard on the pedalboard. Stops from the Swell division are heard on the Swell *manual* or keyboard. Stops from the Great division are heard on the Great manual.

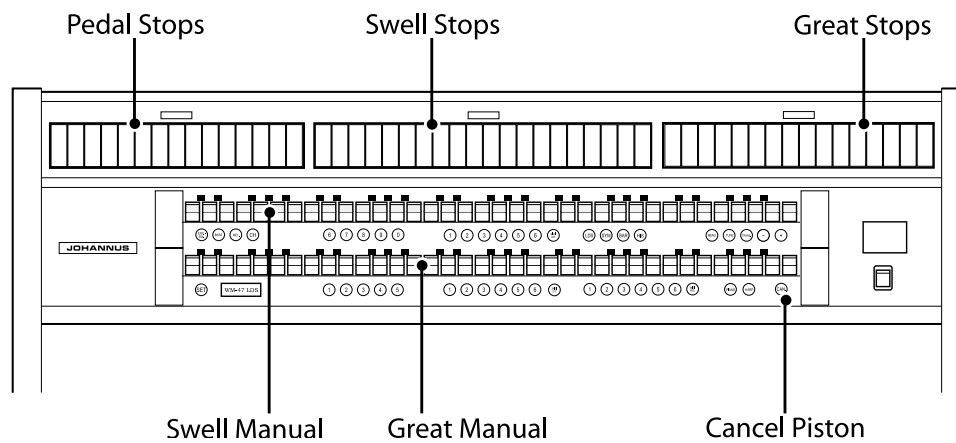

To turn off all stops at once, press the *general cancel piston*.

## PIANO

---

The WM-47 LDS features a piano sample for use where a piano is not available. When the piano is activated all organ stops are deactivated. The piano is playable from the great manual. The middle f# on the pedalboard is functions as a sustain pedal.

Activate the piano by pressing the PIANO piston located below the keyboards on the right.

## COUPLERS

---

Couplers link the stops of one division to another. For example, activate only the Swell Diapason 8'. You will now have sound on the Swell manual but no sound on the Great manual. Now, activate the Swell to Great coupler located to the far right of the Great stops. You will now be able to play the Swell Diapason 8' on the Great manual as well as the Swell.

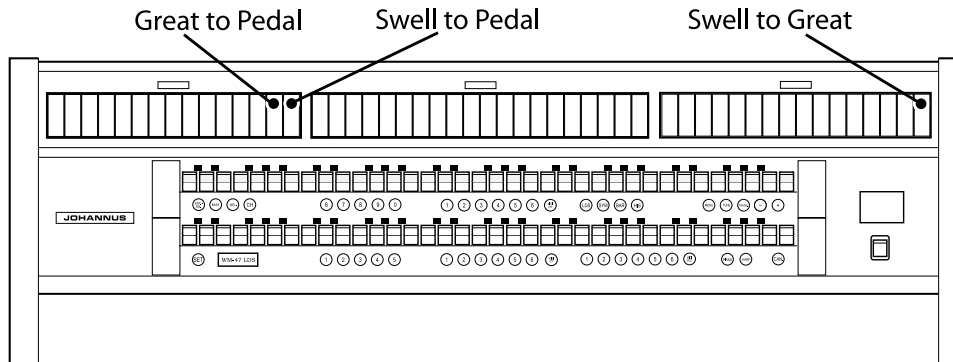

- Great to Pedal links the activated Great stops to the Pedal division.
- Swell to Pedal links the activated Swell stops to the Pedal division.
- Swell to Great links the activated Swell stops to the Great division.



## CONTROLLING VOLUME LEVEL

The volume of the organ can be controlled by adding or removing stops as well as by using the *expression shoes*. Pressing the expression shoe forward (or opening the expression shoe) increases volume. To control the volume of stops on the Great manual and Pedal stops, use the Great/Pedal expression shoe. Volume of stops on the Swell manual are controlled by the Swell expression shoe.

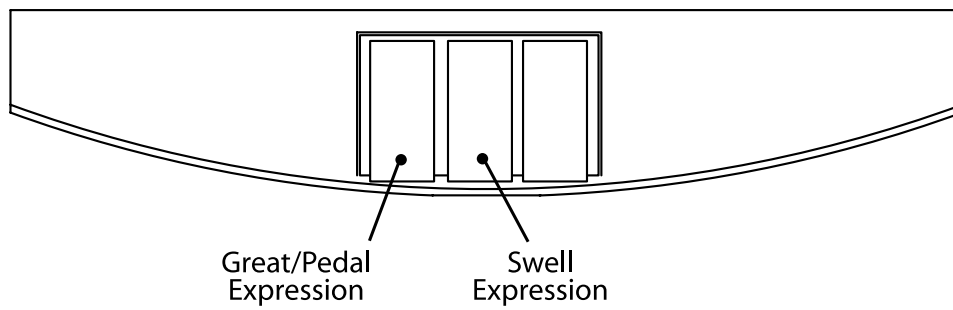

☞ The general volume of your Johannus WM-47 LDS has been set by the installer to successfully accompany congregational singing with the expression shoes fully open or pressed forward.

The positions of the expression shoes are indicated by the bars shown on the display.

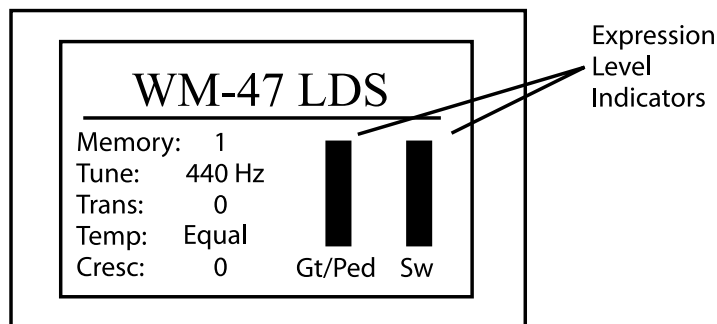

If you would like to control the volume of the entire organ with one expression shoe, use the EXP-SW piston. When the EXP-SW piston is activated, all expression is controlled by the Swell shoe.

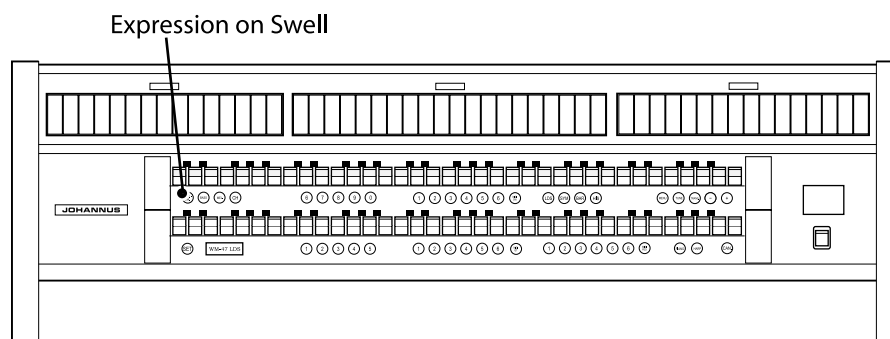

## **CRESCENDO PEDAL**

---

The crescendo pedal or shoe increases volume of the organ by adding stops. The stops light up as the shoe is pressed forward. *The crescendo pedal is normally only used for classical organ literature and choral accompaniment.*

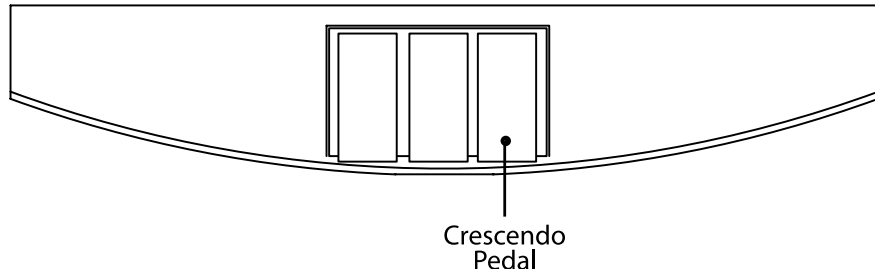

If you cannot get some stops to turn off, check to make sure that the crescendo shoe is not pressed forward.

## GENERAL AND DIVISIONAL PISTONS

---

Pistons (or combination memory) are used to quickly recall stop settings. Pistons can be preset or programmed by the organist. The WM-47 LDS has several sets of pistons to assist you in playing the organ.

*General Pistons* control stops in all divisions (Swell, Great, and Pedal) of the organ.

*Great Divisional Pistons* only control stops in the Great division.

*Swell Divisional Pistons* only control stops in the Swell division.

*Pedal Divisional Pistons* only control stops in the Pedal division.

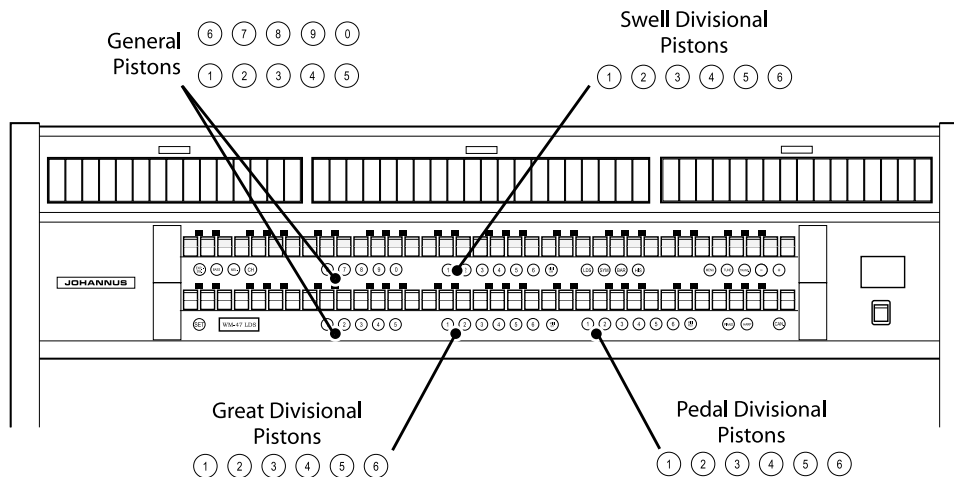

## PRESET GENERAL PISTONS (MEMORY 1 AND 2)

The pistons discussed in the previous section have been preset to help users select stops quickly.

### Preset pistons for congregational singing:

The preset pistons for congregational singing are located on *memory level 1*. Current memory level is indicated in the display.

When the organ is turned on, memory level 1 is selected by default.

On memory level 1 the general pistons are ready for congregational singing. They are programmed from soft (1) to loud (0).

- ☞ The organ will return to these presets every time the organ is turned on. If someone has been using the organ before you, you may wish to turn the organ off, then on again.

### Preset pistons for prelude:

The preset pistons for prelude are located on *memory level 2*. Current memory level is indicated in the display. To advance to memory level 2, press the + piston. Pressing the + and – pistons change memory levels. Current memory level is shown in the display.

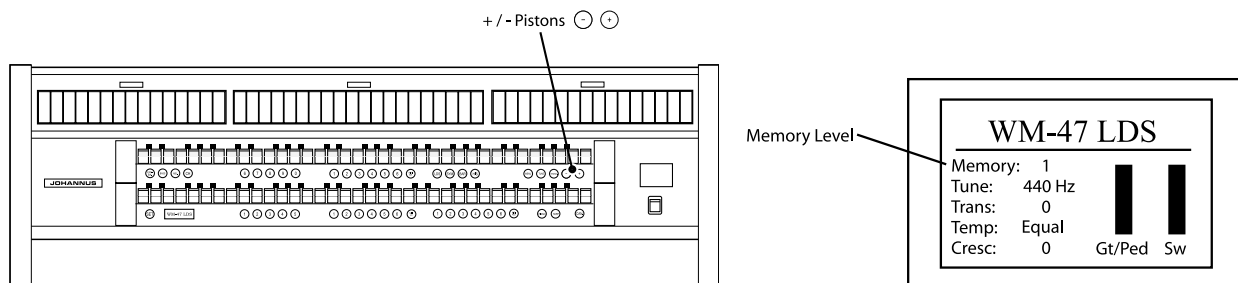

On memory level 2 the general pistons are programmed with combinations suitable for prelude playing.

- ☞ General pistons 1-5 are programmed to play the melody (one note at a time) on the Great manual with the accompaniment on the Swell manual. Alternatively, all parts may be played on the Swell manual only.
- ☞ General pistons 6-0 are programmed to play the melody (one note at a time) on the Swell manual with the accompaniment on the Great manual. Alternatively, all parts may be played on the Great manual only.

The divisional pistons are programmed with additional solo combinations for playing the melody.

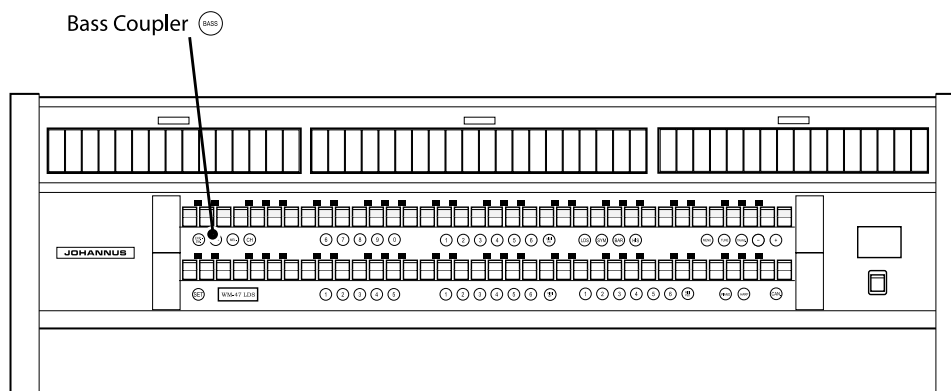
**BASS & MELODY COUPLERS**

The BASS piston activates the *bass coupler*. This is a valuable tool for organists who do not play the pedalboard. When activated, the lowest note played on the Great manual is automatically played on the Pedal stops as well. This imitates the effect of the pedals being played and adds foundation to the organ's sound.

- ☞ The bass coupler only works on the Great manual.
- ☞ Some Pedal stops must be activated for the bass coupler to take effect.
- ☞ The bass coupler will remain active until the BASS piston is pressed again and the light turns off.

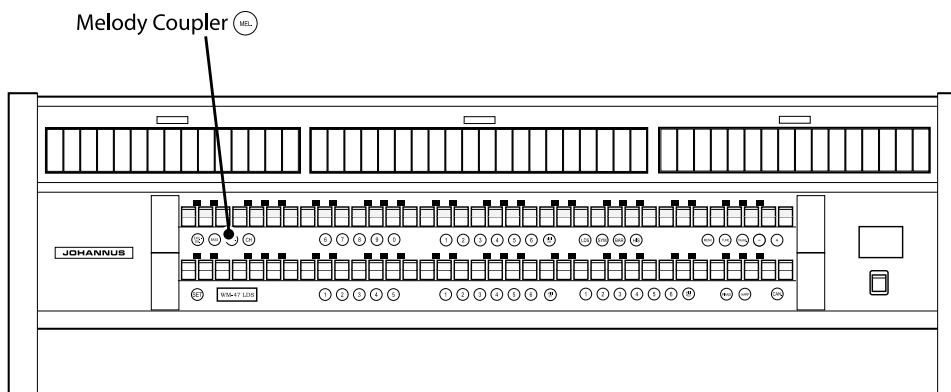

The MEL. piston activates the *melody coupler*. When activated, the highest note played on the Great manual is automatically played on the Swell stops as well. This allows the melody to be heard more clearly. It is also useful for interesting prelude music.

- ☞ The melody coupler only works on the Great manual.
- ☞ At least one Swell stop must be activated for the melody coupler to take effect.
- ☞ The melody coupler will remain active until the MEL. piston is pressed again and the light turns off.

BASIC FUNCTIONS  
**HYMN PLAYER**

---

The Johannus WM-47 LDS organ has the ability to play 162 hymns.

**To activate Hymn Player:**

1. Press the MENU piston.

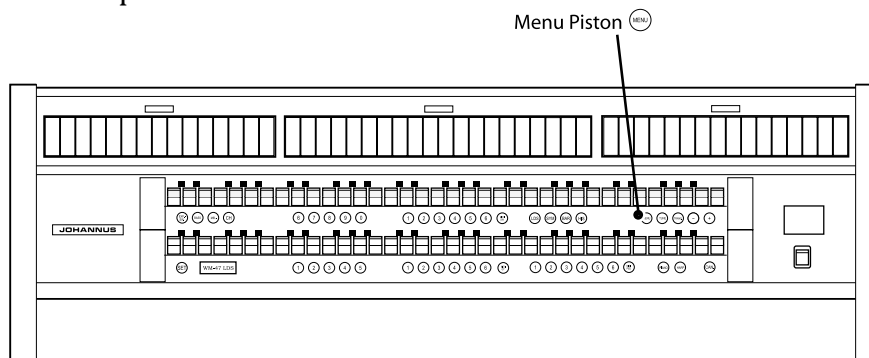

2. The display shows the selection of Hymn Player. If the display does not show Hymn Player as the selection, use the + or – pistons to navigate.
3. Press SET to enter Hymn Player.

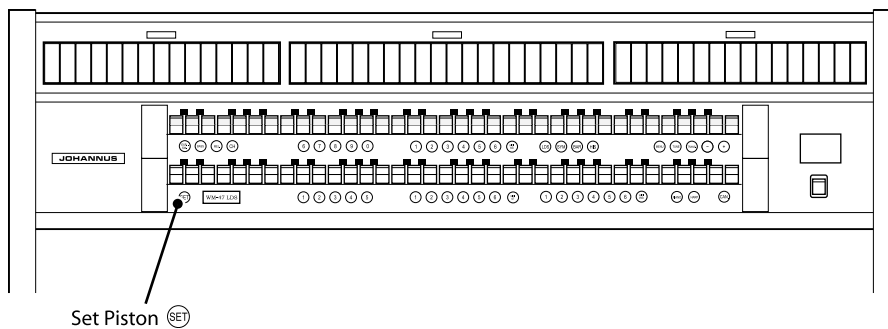

4. Use the + or – pistons to select Hymns, Preludes, or Language Selection as indicated by the arrow on the display.

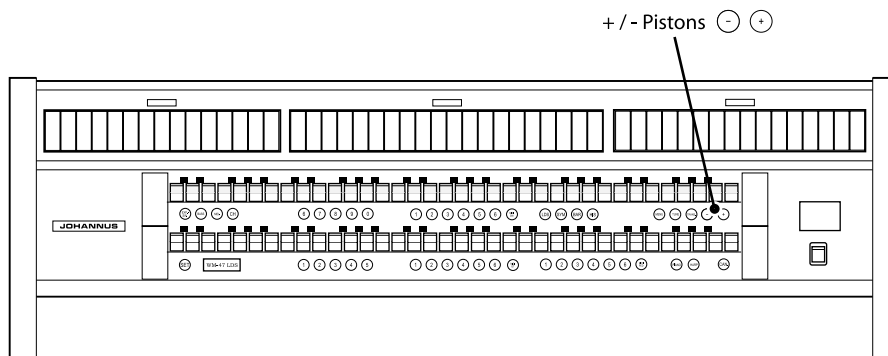

5. Follow instructions for playing hymns or preludes below.

**To play a hymn:**

1. Activate the Hymn Player as described above and select Hymns in step four.

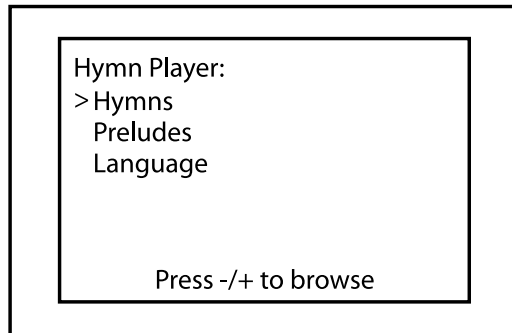

2. Press SET to enter Hymns mode.
3. Enter the hymn number from the English edition of *Hymns* using the general pistons. (If have selected another language from the menu such as Spanish, enter the hymn number from the Spanish hymnal). Three digits must be entered; i.e. to play hymn number 62 you must press general pistons 0, 6, 2.

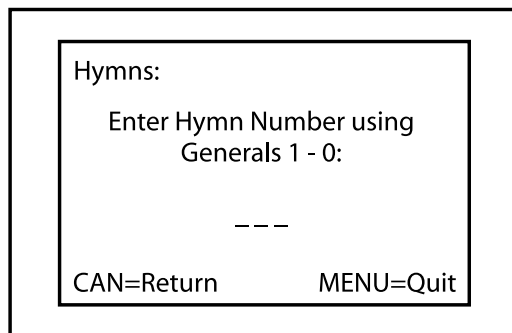

4. Your hymn selection is shown on the display.

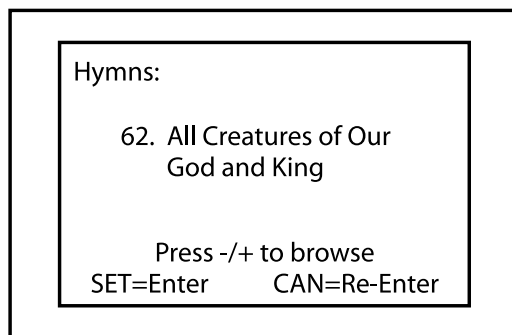

5. Press SET to confirm your selection or press + or – to browse.
6. Select whether to start with an introduction or full verse using the + or – pistons. This is indicated by the arrow on the display pointing to "Play Intro" or "Play Verse".

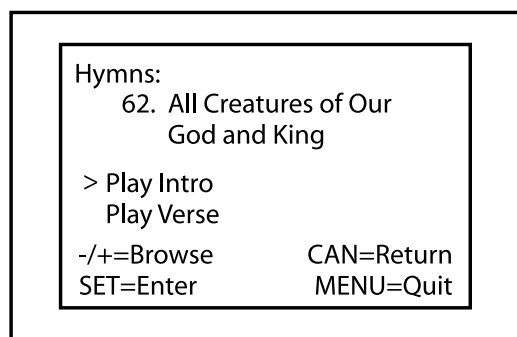

7. Press SET to begin playing the introduction or verse.
8. Adjust the volume using the Swell expression shoe.

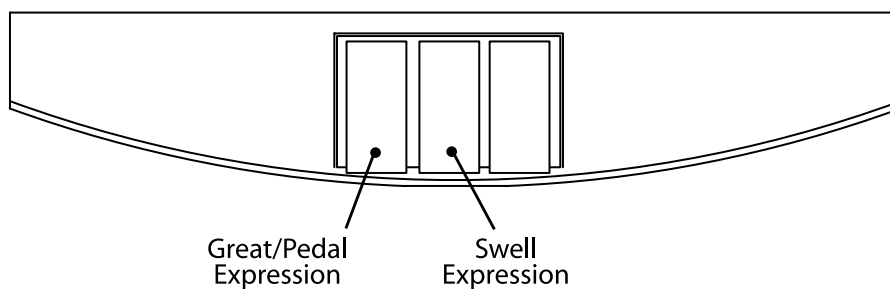

9. Press SET at the end of the introduction or verse to play another verse of the same hymn.
10. Press MENU to return to the main screen.

### To play prelude music:

1. Activate the Hymn Player as described above and select Preludes in step four.
2. Press SET to enter Preludes mode.

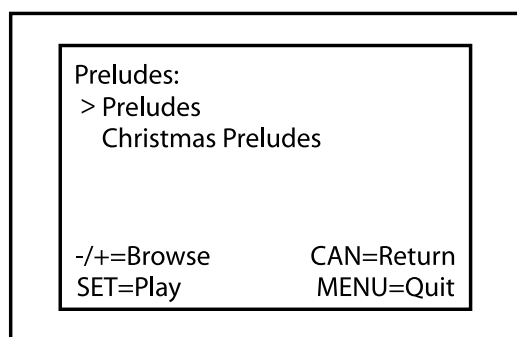

3. Select Preludes or Christmas Preludes using + and - pistons.
4. Press SET to begin prelude playback.



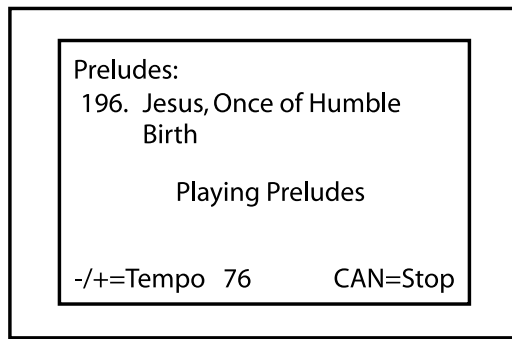

5. Adjust the volume using the Swell expression shoe.
6. Press CAN. to stop Preludes.
7. Press MENU several times to return to the main screen.

☝ The Prelude Player always plays the preludes in the same order for smooth transitions from song to song. However, it always begins with a different hymn to increase variety. The prelude player contains 50 hymns played twice each.

#### ADVANCED FUNCTIONS

### PROGRAMMING PISTONS

The Johannus WM-47 LDS features 100 memory levels. Memory levels 1 and 2 are preset and cannot be changed. However, memory levels 3-100 are available to program as needed.

Program pistons as follows:

1. Select a memory level (3-100) by using the + and - pistons.

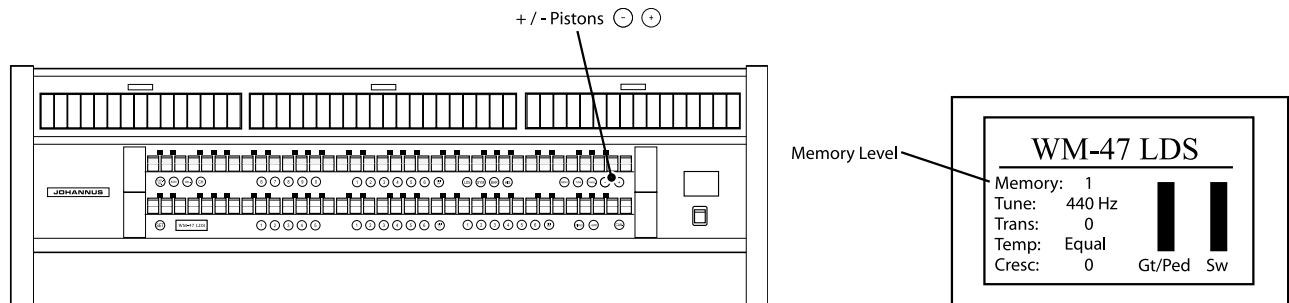

2. Set the desired stops by hand.
3. Press and hold SET.

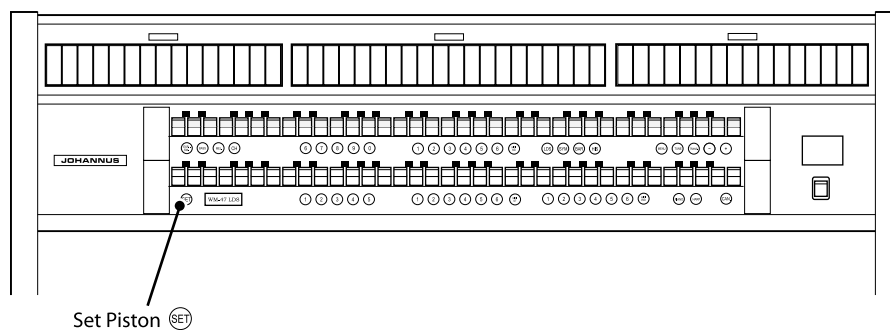

4. Press and release the piston you wish to program.
5. Release SET.

- ☞ Remember that memory levels 1 and 2 are locked. If you try to program a piston on memory level 1 or 2 it will not work.
- ☞ If you wish to program stops on all divisions at once, make sure you use a general piston. Divisional pistons will only recall stops in their respective divisions.
- ☞ You may wish to coordinate assignment of memory levels with other organists in your building in order to avoid confusion.

#### ADVANCED FUNCTIONS

### TRANSPOSER

It is possible to automatically transpose your playing up or down in half-step increments.

1. Press the TRANS. piston.
2. Press + or - to transpose the playing up or down in half-step increments.
3. The position of the transposer is indicated in the display.

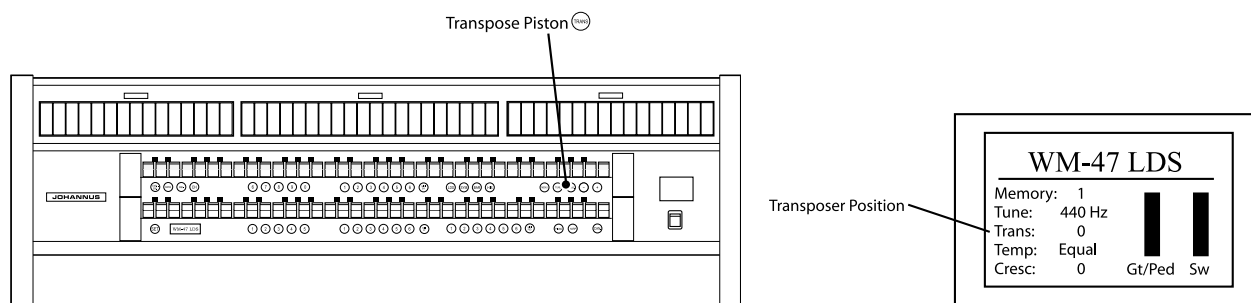

- ☞ You must press + or - before the TRANS. piston light goes out (about 5 seconds). When TRANS. is not lit, + and - change memory levels.
- ☞ When the organ is turned off, the transposer will automatically reset to the 0 position.

## TUNING

It is possible to tune the organ for playing with other instruments (e.g., a piano that is a bit flat).

1. Press the TUNE piston.
2. Press + or - to tune the organ up or down incrementally
3. The position of the tuner is indicated in the display.

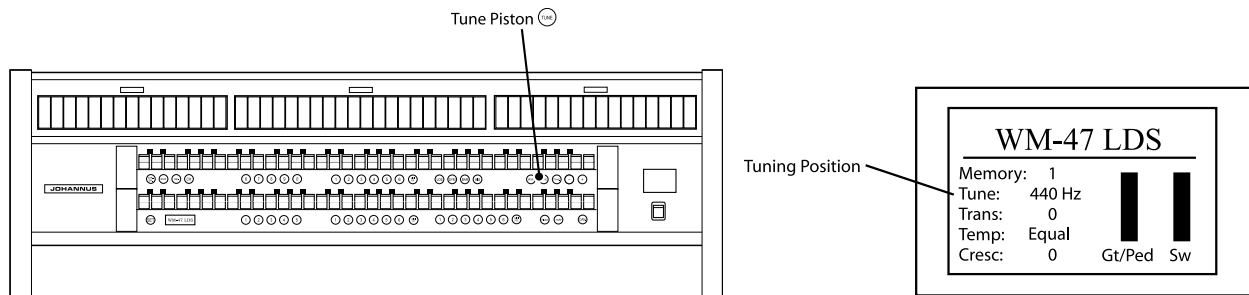

- ☞ You must press + or - before the TUNE piston light goes out (about 5 seconds). When TUNE is not lit, + and - change memory levels.
- ☞ When the organ is turned off, the tuning will automatically return to the standard A440.

## CHORUS TUNING

A pipe organ is never perfectly in tune. That is part of what gives a pipe organ its character. By activating the CHORUS piston, the tuning between different stops on the organ becomes more varied to imitate this characteristic of a pipe organ.

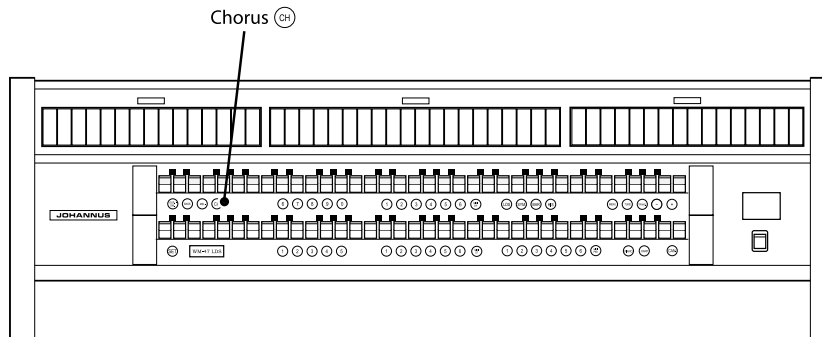

## STOPLISTS

---

Pipe organs are built in many styles. The primary style of the Johannus WM-47 LDS is American Classic. It is possible to change the style of the organ to French Symphonic, Baroque, or Historic by pressing one of the stoplist pistons.

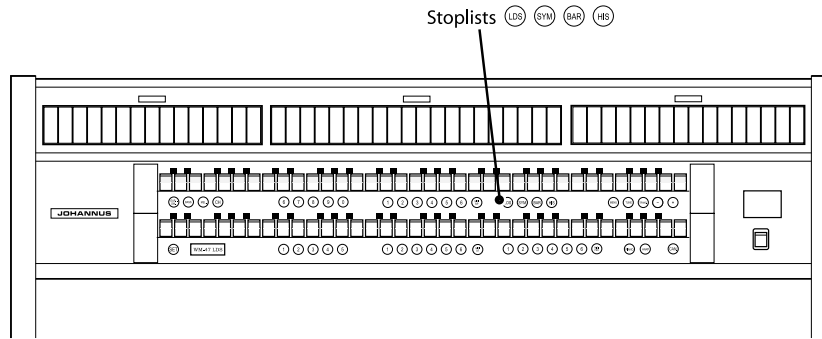

## SELECTING HARP STYLE

---

The organ features three different harp samples. The default sample is the orchestral harp. To change to another harp sample:

1. Press the MENU piston.
2. Use the + / - pistons to select Orchestrals from the menu.
3. Press SET.
4. Use the + / - pistons to select harp.
5. Press SET.
6. Use the + / - pistons to select the harp style.
7. Press SET.

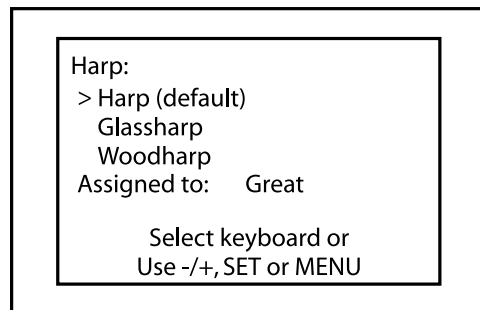

## TUTTI

---

Tutti is used to quickly engage full organ. Press the Tutti thumb piston to engage and disengage Tutti.

## PROGRAMMABLE MIDI

---

The organ features MIDI couplers for controlling external MIDI devices.

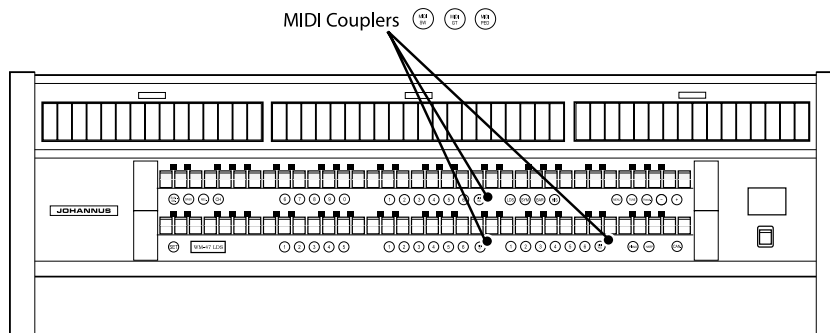

With the programmable MIDI stops, you can control any module voice (1-128) through any MIDI channel (1-16).

1. Press the MENU piston.
2. Select "Programmable MIDI" from the menu.
3. Press SET. "MIDI:" appears on the display.
4. Select the MIDI stop to be programmed (for example, MIDI Swell). On the display, "MIDI: Swell" now appears.
5. Use the + and - pistons to select the desired channel.
6. Press SET.
7. Use the + and - pistons to select the desired MIDI voice number.
8. Press SET. The selected adjustments are now stored in memory.
9. Select another MIDI stop to be programmed if desired.
10. Press MENU to return to the main menu.
11. Press MENU again to exit the Easy Menu.

**OTHER MENU ITEMS**

---

**Reset Procedures**

The Reset Procedures function is used to delete the capture memory, or to reset a number of settings to the factory settings.

1. Push the MENU piston.
2. Use the - and + pistons to select the Reset Procedures function on the display.
3. Push the SET piston. The display shows the menu for the Reset Procedures.
4. Use the - and + pistons to select the desired procedure.
5. Push the SET piston. The display requests confirmation.
6. Use the - and + pistons for No or Yes.
7. Push the SET piston for confirmation.
8. Press the MENU piston to return to the main menu.
9. Press the MENU piston again to exit the Easy Menu.

**Data Dump Mode**

The Data Dump Mode function sends settings from the organ to a storage medium (for example a sequencer) through the MIDI SEQ. output.

1. Push the MENU piston.
2. Use the - and + pistons to select the Data Dump Mode function on the display.
3. Push the SET piston. The Press Set piston text appears on the display.
4. Make sure the desired storage medium is properly connected.
5. Push the SET piston again. When data is being sent, Sending data appears on the display.



Do not use the organ when the text “Sending Data” is on the display.

6. Press the MENU piston in to return to the main menu.
7. Press the MENU piston in again to exit the Easy Menu.

## UNDERSTANDING STOPS

---

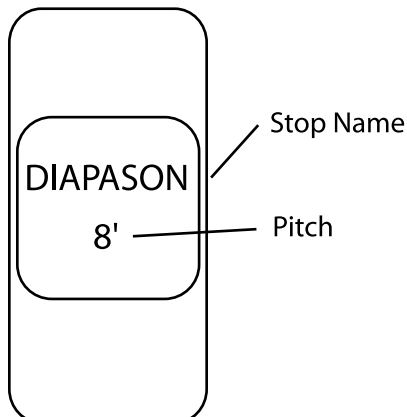

Stops control the voices of the organ and have various names. When a stop is activated you will hear its voice when keys are played.

Each stop is labeled to identify its voice. The words on the stop tab show the name of the stop. The stop name gives you an idea of what sound you will hear from the stop. The number identifies the pitch of the voice.

### FAMILIES OF ORGAN STOPS

Organ stops are divided into four basic families: diapasons/principals, flutes, strings and reeds. We will detail all of the stops on the Johannus WM-47 LDS and place them in their respective families.

#### **Diapasons (Principals)**

The diapason or principal is the basic foundation voice and is unique to the organ. This is the predominate sound in a good full organ ensemble and is essential in accompanying hymn singing. The following diapason names are used on the Johannus LDS organ: diapason, principal, octave, and choral bass.

#### **Flutes**

Flute stops on the organ are imitative of the sound of an orchestral flute. These stops are gentle and sweet in nature, but may vary considerably depending upon the construction of the pipe. The following flute names are used on the Johannus LDS organ: flute, bourdon, and gedeckt.

#### **Strings**

String stops possess more harmonic development than the basic flute stops and are imitative of stringed instruments. Stops in this family are used as warm and ethereal accompaniment stops, mix well with other stops, and are generally the softer stops on the organ. The following string names are used on the Johannus LDS organ: viola di gamba, voix celeste, aeoline celeste, contra violone, and gemshorn (a hybrid stop with flute and string characteristics).

## **Reeds**

The sound from reed pipes is produced by using a brass reed and resonator and imitate many brass and woodwind instruments. These can be either solo reeds or chorus reeds. Solo reeds are somewhat imitative of orchestral reed instruments and are used almost exclusively for solo passages; chorus reeds are used in combination with other reeds or to add "fire" to the Principal/Diapason chorus. The reeds on the Johannus LDS organ are printed in red ink.

## **Harmonic Corroborating Stops**

**MIXTURES** - Mixtures contain multiple pipes sounding simultaneously and are indicated by a roman numeral after the name. These stops add brightness and clarity to the choruses of the organ. For example, adding the Full Mixture IV to the Open Diapason 8', Octave 4' and Super Octave 2' on the Great adds clarity and sparkle needed for large congregations or rousing hymns.

**MUTATIONS** - Mutations is usually a stop of flute or principal tone which speaks at a pitch not related to the fundamental by an octave and are indicated by fractional numbers after the name. A  $2 \frac{2}{3}'$  pipe sounds an octave and a fifth above the note you play;  $1 \frac{3}{5}'$  two octaves and a third. These add interesting color when used with the fundamental pitches (8' flute, etc.) of the organ.

**HYBRIDS** - These are stops that could fall into more than one of the families of stops. The Johannus LDS organ has some gemshorn stops that are hybrid between flute and string, but lean more toward the string sound.

## **Percussion Voices**

The Johannus LDS organ has a percussive solo stop called chimes. They are played from the Great keyboard. If the key is struck and released quickly, the chime will decay quickly. To make the chime ring longer, simply hold the key down longer.



## PITCHES OF ORGAN STOPS

The numbers associated with the names of the stops indicate the pitch at which the stop will sound. 8' (eight foot) is the basic pitch on the manuals (keyboards) and is the pitch at which a piano sounds. Dividing or multiplying the 8' pitch results in higher or lower pitches. For example, if you play middle C on a 4' stop it will sound one octave higher than middle C; 2' would be two octaves higher. 16' stops are an octave lower than 8' stops; 32' stops are two octaves lower. See Mutations under Families of Organ Stops for explanations of fractional pitches.



## BASIC REGISTRATION CONCEPTS

---

In LDS church services, the primary use of the organ is accompaniment of congregational singing. Proper registration will help encourage the congregation to sing. Consider the following items when choosing stops for a hymn:

- Will the registration adequately support the congregation?
- Using stops from the diapason/principal chorus especially at the 8' level is the beginning of a good foundation.
- For singers in a congregation to still be able to hear the organ and be encouraged to sing, stops above the 8' level (i.e. 4' and higher for brighter hymns) in the hands are necessary, except for the softest of hymns, such as some verses of sacrament hymns.
- Using Pedal stops will add necessary support to the hymn. Use at least 16' and 8' Pedal stops.
- Read the text of the hymn.
- Use registrations that reflect the message of the hymn.
- Diapasons/principals at 8', 4', 2' and a Mixture in the hands would be appropriate for a hymn such as "The Spirit of God," but would not be suitable for a sacramental hymn.
- The organ must provide a solid pitch for the singers.
- DO NOT use tremulant for congregational singing. It makes it too difficult for the singers to find their pitches.
- Celestes may also make it difficult for singers to find their proper pitches.
- Inspire the congregation to sing.
- Change registration between verses when appropriate.
- Don't be timid. Play loud enough that the congregation doesn't feel "alone," however, do not overpower the congregation. Remember that you are closer to the source of organ sound than the singers are and the organ may sound too loud to you but may not be supporting the congregation adequately.

## SUGGESTED HYMN REGISTRATIONS

---

### Quiet Hymn

Great		Swell		Pedal	
Open Diapason	8'	Gedeckt	8'	Bourdon	16'
Harmonic Flute	4'	Chimney Flute	4'	Bass Flute	8'
Swell to Great					

### Moderately Quiet Hymn

Great		Swell		Pedal	
Open Diapason	8'	Diapason	8'	Open Diapason	16'
Octave	4'	Gedeckt	8'	Octave	8'
Swell to Great		Principal	4'		
		Chimney Flute	4'		

### Medium Hymn

Great		Swell		Pedal	
Open Diapason	8'	Diapason	8'	Open Diapason	16'
Stopped Flute	8'	Gedeckt	8'	Octave	8'
Octave	4'	Principal	4'	Choral Bass	4'
Harmonic Flute	4'	Chimney Flute	4'		
Swell to Great		Piccolo	2'		

### Moderately Strong Hymn

Great		Swell		Pedal	
Open Diapason	8'	Diapason	8'	Open Diapason	16'
Stopped Flute	8'	Gedeckt	8'	Octave	8'
Octave	4'	Principal	4'	Choral Bass	4'
Harmonic Flute	4'	Chimney Flute	4'		
Super Octave	2'	Piccolo	2'		
Swell to Great					

### Moderately Strong Hymn

Great		Swell		Pedal	
Open Diapason	8'	Diapason	8'	Open Diapason	16'
Stopped Flute	8'	Gedeckt	8'	Octave	8'
Octave	4'	Principal	4'	Choral Bass	4'
Harmonic Flute	4'	Chimney Flute	4'	Swell to Pedal	
Super Octave	2'	Piccolo	2'		
Swell to Great		Oboe	8'		

## Strong Hymn

<b>Great</b>		<b>Swell</b>		<b>Pedal</b>	
Open Diapason	8'	Diapason	8'	Open Diapason	16'
Stopped Flute	8'	Gedeckt	8'	Bourdon	16'
Claribel Flute	8'	Principal	4'	Octave	8'
Octave	4'	Chimney Flute	4'	Bass Flute	8'
Harmonic Flute	4'	Piccolo	2'	Choral Bass	4'
Octave Quint	2 2/3'	Mixture	IV	Mixture	III
Super Octave	2'			Great to Pedal	
Full Mixture	IV			Swell to Pedal	
Swell to Great					

## Strong Hymn

<b>Great</b>		<b>Swell</b>		<b>Pedal</b>	
Open Diapason	8'	Diapason	8'	Open Diapason	16'
Stopped Flute	8'	Gedeckt	8'	Bourdon	16'
Octave	4'	Principal	4'	Octave	8'
Harmonic Flute	4'	Chimney Flute	4'	Bass Flute	8'
Octave Quint	2 2/3'	Piccolo	2'	Choral Bass	4'
Super Octave	2'	Mixture	IV	Mixture	III
Full Mixture	IV	Trumpet	8'	Fagotto	16'
Swell to Great				Great to Pedal	
				Swell to Pedal	

## Strong Hymn (Perhaps Final Verse)

<b>Great</b>		<b>Swell</b>		<b>Pedal</b>	
Bourdon	16'	Diapason	8'	Contra Violone	32'
Open Diapason	8'	Gedeckt	8'	Open Diapason	16'
Stopped Flute	8'	Principal	4'	Bourdon	16'
Octave	4'	Chimney Flute	4'	Octave	8'
Harmonic Flute	4'	Piccolo	2'	Bass Flute	8'
Octave Quint	2 2/3'	Mixture	IV	Choral Bass	4'
Super Octave	2'	Trumpet	8'	Mixture	III
Full Mixture	IV	Clarion	4'	Fagotto	16'
Posaune	8'			Trumpet	8'
Swell to Great				Clarion	4'
				Great to Pedal	
				Swell to Pedal	

## SUGGESTED PRELUDE REGISTRATIONS

---

### Both Hands on One Manual

<b>Great</b>		<b>Swell</b>		<b>Pedal</b>	
Gemshorn	8'	Gedeckt	8'	Echo Bourdon	16'
Gemshorn Celeste	8'	Flute Celeste	8'	Swell to Pedal	
Swell to Great		Viola di Gamba	8'		
		Voix Celeste	8'		

---

<b>Great</b>		<b>Swell</b>		<b>Pedal</b>	
Stopped Flute	8'	Viola di Gamba	8'	Echo Bourdon	16'
		Voix Celeste	8'		

---

<b>Great</b>		<b>Swell</b>		<b>Pedal</b>	
Stopped Flute	8'	Gedeckt	8'	Echo Bourdon	16'
Harmonic Flute	4'	Flute Celeste	8'	Great to Pedal	
Swell to Great					

### Melody on Great, Accompaniment on Swell

<b>Great</b>		<b>Swell</b>		<b>Pedal</b>	
Cromorne	8'	Viola di Gamba	8'	Echo Bourdon	16'
		Voix Celeste	8'	Swell to Pedal	

---

<b>Great</b>		<b>Swell</b>		<b>Pedal</b>	
Bourdon	16'	Gedeckt	8'	Echo Bourdon	16'
Harmonic Flute	4'				
Tremulant					

---

<b>Great</b>		<b>Swell</b>		<b>Pedal</b>	
Chimes		Viola di Gamba	8'	Echo Bourdon	16'
		Voix Celeste	8'	Swell to Pedal	
		Aeoline Celeste II	8'		

---

<b>Great</b>		<b>Swell</b>		<b>Pedal</b>	
Posaune	8'	Gedeckt	8'	Echo Bourdon	16'
		Chimney Flute	4'	Bass Flute	8'

## Melody on Swell, Accompaniment on Great

<b>Great</b>		<b>Swell</b>		<b>Pedal</b>	
Gemshorn	8'	English Horn	8'	Echo Bourdon	16'
Gemshorn Celeste	8'			Great to Pedal	

---

<b>Great</b>		<b>Swell</b>		<b>Pedal</b>	
Stopped Flute	8'	Gedeckt	8'	Echo Bourdon	16'
		Nasard	2 2/3'	Great to Pedal	
		Tremulant			

---

<b>Great</b>		<b>Swell</b>		<b>Pedal</b>	
Stopped Flute	8'	Gedeckt	8'	Echo Bourdon	16'
Gemshorn	8'	Chimney Flute	4'	Great to Pedal	
Gemshorn Celeste	8'	Nasard	2 2/3'		
		Piccolo	2'		
		Tierce	1 3/5'		

---

<b>Great</b>		<b>Swell</b>		<b>Pedal</b>	
Gemshorn	8'	Gemshorn	16'	Echo Bourdon	16'
Gemshorn Celeste	8'	Gedeckt	8'	Bass Flute	8'
		Chimney Flute	4'		
		Piccolo	2'		
		Tremulant			

---

<b>Great</b>		<b>Swell</b>		<b>Pedal</b>	
Stopped Flute	8'	Oboe	8'	Echo Bourdon	16'
Harmonic Flute	4'			Great to Pedal	

## HYMN PLAYER CONTENTS

---

### A

A Mighty Fortress Is Our God.....	68
A Poor Wayfaring Man of Grief.....	29
Abide with Me!.....	166
Abide with Me; 'Tis Eventide.....	165
All Creatures of Our God and King.....	62
All Glory, Laud, and Honor.....	69
An Angel from on High.....	13
Angels We Have Heard on High.....	203
As I Search the Holy Scriptures.....	277
As Sisters in Zion.....	309
As the Dew from Heaven Distilling.....	149
Away in a Manger.....	206

### B

Be Thou Humble.....	130
Because I Have Been Given Much.....	219
Behold! A Royal Army.....	251
Behold the Great Redeemer Die.....	191

### C

Called to Serve.....	249
Carry On.....	255
Children of Our Heavenly Father.....	299
Choose the Right.....	239
Christ the Lord Is Risen Today.....	200
Come, All Ye Sons of God.....	322
Come, Come, Ye Saints.....	30
Come, Follow Me.....	116
Come, Listen to a Prophet's Voice.....	21
Come, O Thou King of Kings.....	59
Come, Thou Glorious Day of Promise.....	50
Come unto Jesus.....	117
Come, We That Love the Lord.....	119
Come, Ye Children of the Lord.....	58
Come, Ye Thankful People.....	94
Count Your Blessings.....	241

### D

Dear to the Heart of the Shepherd.....	221
Dearest Children, God Is Near You.....	96
Did You Think to Pray?.....	140
Do What Is Right.....	237

### E

Each Life That Touches Ours for Good.....	293
---	-----

### F

Families Can Be Together Forever.....	300
Far, Far Away on Judea's Plains.....	212
Father in Heaven.....	133
For the Beauty of the Earth.....	92
For the Strength of the Hills.....	35

### G

Gently Raise the Sacred Strain.....	146
Glory to God on High.....	67
Go Forth with Faith.....	263
God Be with You Till We Meet Again.....	152
God Bless Our Prophet Dear.....	24

God Is Love.....	87
God Loved Us, So He Sent His Son.....	187
God of Our Fathers, Whose Almighty Hand.....	78
God, Our Father, Hear Us Pray.....	170
God's Daily Care.....	306
Guide Us, O Thou Great Jehovah.....	83

### H

Hark, All Ye Nations!.....	264
Hark! The Herald Angels Sing.....	209
Have I Done Any Good?.....	223
He Is Risen!.....	199
Help Me Teach with Inspiration.....	281
High on the Mountain Top.....	5
Home Can Be a Heaven on Earth.....	298
Hope of Israel.....	259
How Firm a Foundation.....	85
How Gentle God's Commands.....	125
How Great the Wisdom and the Love.....	195
How Great Thou Art.....	86
How Wondrous and Great.....	267

### I

I Am a Child of God.....	301
I Believe in Christ.....	134
I Heard the Bells on Christmas Day.....	214
I Know My Father Lives.....	302
I Know That My Redeemer Lives.....	136
I Need Thee Every Hour.....	98
I Stand All Amazed.....	193
I'll Go Where You Want Me to Go.....	270
Improve the Shining Moments.....	226
In Humility, Our Savior.....	172
In Memory of the Crucified.....	190
In Our Lovely Deseret.....	307
Israel, Israel, God Is Calling.....	7
It Came upon the Midnight Clear.....	207

### J

Jehovah, Lord of Heaven and Earth.....	269
Jesus, Lover of My Soul.....	102
Jesus of Nazareth, Savior and King.....	181
Jesus, Once of Humble Birth.....	196
Jesus, the Very Thought of Thee.....	141
Joseph Smith's First Prayer.....	26
Joy to the World.....	201

### K

Keep the Commandments.....	303
----------------------------	-----

### L

Lead, Kindly Light.....	97
Let the Holy Spirit Guide.....	143
Let Us All Press On.....	243
Let Us Oft Speak Kind Words.....	232
Lord, Dismiss Us with Thy Blessing.....	163
Lord, I Would Follow Thee.....	220
Lord, We Ask Thee Ere We Part.....	153
Love at Home.....	294
Love One Another.....	308

<hr/>	
M	
Master, the Tempest Is Raging .....	105
More Holiness Give Me .....	131
My Redeemer Lives .....	135
<hr/>	
N	
Nearer, My God, to Thee .....	100
Now Let Us Rejoice .....	3
Now the Day Is Over .....	159
<hr/>	
O	
Oh, Come, All Ye Faithful .....	202
O God, the Eternal Father .....	175
O Little Town of Bethlehem .....	208
O Love That Glorifies the Son .....	295
O My Father .....	292
Oh Say, What Is Truth? .....	272
O Thou Kind and Gracious Father .....	150
Onward, Christian Soldiers .....	246
Our Savior's Love .....	113
<hr/>	
P	
Praise God, from Whom All Blessings Flow .....	242
Praise to the Man .....	27
Prayer Is the Soul's Sincere Desire .....	145
Prayer of Thanksgiving .....	93
Press Forward, Saints .....	81
Put Your Shoulder to the Wheel .....	252
Redeemer of Israel .....	6
Rejoice, the Lord Is King! .....	66
Rise, Ye Saints, and Temples Enter .....	287
<hr/>	
S	
Scatter Sunshine .....	230
Secret Prayer .....	144
Silent Night .....	204
Sing We Now at Parting .....	156
Softly Now the Light of Day .....	160
Sweet Hour of Prayer .....	142
Sweet Is the Work .....	147

<hr/>	
T	
Teach Me to Walk in the Light .....	304
Testimony .....	137
The Day Dawn Is Breaking .....	52
The First Noel .....	213
The Iron Rod .....	274
The Light Divine .....	305
The Lord Is My Light .....	89
The Lord Is My Shepherd .....	108
The Morning Breaks .....	1
The Spirit of God .....	2
The Time Is Far Spent .....	266
There Is a Green Hill Far Away .....	194
There Is Sunshine in My Soul Today .....	227
Though Deepening Trials .....	122
Thy Spirit, Lord, Has Stirred Our Souls .....	157
Today, While the Sun Shines .....	229
True to the Faith .....	254
Truth Reflects upon Our Senses .....	273
Turn Your Hearts .....	291
<hr/>	
U	
Upon the Cross of Calvary .....	184
<hr/>	
W	
We Are All Enlisted .....	250
We Are Marching on to Glory .....	225
We Are Sowing .....	216
We Ever Pray for Thee .....	23
We Thank Thee, O God, for a Prophet .....	19
We'll Sing All Hail to Jesus= Name .....	182
Welcome, Welcome, Sabbath Morning .....	280
When Faith Endures .....	128
Where Can I Turn for Peace? .....	129
While of These Emblems We Partake .....	174
With Wondering Awe .....	210
<hr/>	
Y	
Ye Elders Of Israel .....	319
Ye Who Are Called to Labor .....	321
You Can Make the Pathway Bright .....	228



## MAINTENANCE

---

### Cabinet Maintenance

The cabinet is made of solid wood and wood veneer.



Do not use furniture polish or teak oil to clean the organ cabinet.  
Direct sunlight may discolor the organ cabinet.

1. Clean the organ with a damp cloth.
2. Rub the cabinet dry with a lint-free cloth.

### Keyboard Maintenance

The keyboards are made of man-made synthetic.



Do not use aggressive cleaning agents such as paint thinner or acetone to remove dirt.

1. Clean the keyboards with a damp cloth.
2. Rub the manuals dry with a lint-free cloth.
3. Remove any scratches with car polish.

## WARRANTY

---

The conditions are specified in the warranty certificate. The warranty becomes null and void if changes or repairs are made to the organ by persons or organizations that are not authorized by Johannus Orgelbouw b.v.

## TROUBLESHOOTING

---

If you are experiencing problems with the organ, check here first. If your problem is not listed or the recommended solution does not correct the problem, please contact your Johannus dealer or Johannus-LDS Support.

Symptom: Some or all of the pedals don't work.

Solution: Make sure that the pedalboard is slid tightly against the organ console.

Symptom: Some stops are stuck on.

Solution: Make sure the general crescendo pedal is in the zero position (off). The crescendo pedal lights stops as they are activated and cannot be canceled manually or with the cancel piston.

Symptom: I cannot program a piston.

Solution: Make sure you are not trying to program pistons on memory level one or two. Both memory levels one and two are locked and cannot be changed. Please select a memory level between 3 and 100.

Symptom: My programmed piston does not recall all of the stops I selected.

Solution: Make sure you are using a general piston if you would like to store and recall stops on all divisions of the organ.

## EXTERNAL CONNECTIONS

---

The external connections are located under the left side of the keyboards.

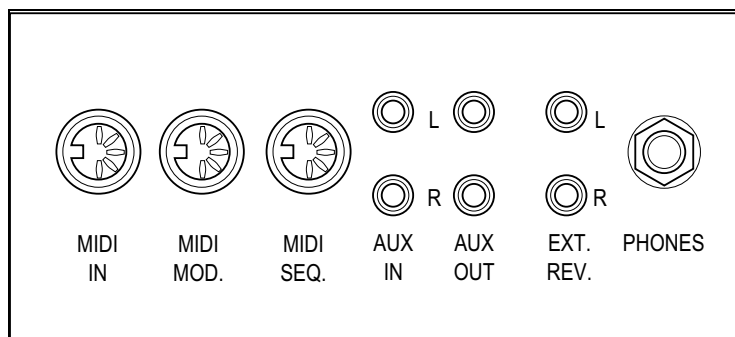

**MIDI IN:** This is an input for receiving MIDI codes from other devices.

**MIDI MOD:** This is a programmable MIDI output for connecting a module or expander.

**MIDI SEQ:** This is a non-programmable MIDI output for connecting a sequencer or PC (with the Johannus Intonat voicing software).

**AUX IN:** This is a stereo input for playing the sound of an external device through the amplifiers of the organ. For example, an expander that is connected to the organ through MIDI MOD can be played through the instrument's loudspeakers.



The volume of the device that is connected through the AUX IN cannot be adjusted with the general volume or the expression pedals. However, this is possible if the volume setting of the external device is controlled by means of MIDI codes through the MIDI MOD. connection of the instrument.

**AUX OUT:** This is an output for connecting an external stereo amplifier or recording device.

**EXT. REV.:** This is an output for connecting Johannus external acoustics. This is a system that imitates the spatial effect of a concert hall or cathedral.



Do not use this output for other purposes.

**PHONES:** This connection for a stereo headphone is suited for a headphone with an impedance of 30Ω or higher (see headphone specifications).



When the headphone is used, the internal and/or external loudspeakers of the organ are automatically switched off.

## MIDI IMPLEMENTATION CHART

Functions		Transmitted	Recognized	Remarks
<b>Basic Channel</b>	Default Changes	See MIDI Specs See MIDI Specs	See MIDI Specs Y	See MIDI Specs
<b>Mode</b>	Default Messages Altered	Mode 3 N *****	Mode 3 N N	
<b>Note Number</b>	True Voice	36-96 *****		
<b>Velocity</b>	Note ON  Note OFF	9nH=1-127 9nH (v=64) 9nH (v=0)	9nH=1-127 9nH=1-127 9nH=0, 8nH v=*	Velocity ON Velocity OFF  *=irrelevant
<b>After Touch</b>	Keys Channels	N N		
<b>Pitch Bend</b>		N		
<b>Control Change</b>	7 11 100/101/6 100/101/6	Y Y Y Y	Y Y Y Y	General Volume Expr. Pedals Pitch Transposer
<b>Program Change</b>	: True # *****	See MIDI Specs	See MIDI Specs See MIDI Specs	See MIDI Specs See MIDI Specs
<b>System Exclusive</b>		See MIDI Specs	See MIDI Specs	See MIDI Specs
<b>Common</b>	: Song Pos : Song Sel : Tune	N N N	N N N	
<b>System Real Time</b>	: Clock : Commands	N N	N N	
<b>Aux</b>	: Reset All Contr. : Local ON/OFF : All Notes OFF : Active Sense : Reset	N N Y N N	N N Y N N	

Mode 1: OMNY ON, POLY  
Mode 3: ONMY OFF, POLY

Mode 2: OMNY ON, MONO  
Mode 4: OMNY OFF, MONO

Y = YES  
N = NO

**MIDI SPECIFICATIONS**

---

**Default Basic Channels (transmitted/recognized)**

- 1: Great Notes
- 2: Swell Notes
- 3: Pedal Notes
- 12: Stops

**Basic Channel Changes (transmitted)**

Can be programmed in the Programmable MIDI menu.

**Control Changes (transmitted)**

Controller 7 (07h)	General volume, with volume values 40 (28h) – 127 (7Fh).
Controller 11 (0Bh)	Expression pedals, with volume values 63 (3Fh) – 127 (7Fh).
Controller 6 (06h)	Pitch, with pitch values 33 (21h) – 95 (5Fh). Pitch value 64 (40h) = A = 440 Hz. The following applies to pitch: LSB 100(64h) 1(01h) MSB 101(65h) 0(00h)
	Transposer, with transposer values 61 (3Dh) – 67 (43h). Transposer value 64 (40h) = A = 440 Hz. The following applies to the transposer: LSB 100(64h) 2(01h) MSB 101(65h) 0(00h)

**Control Changes (recognized)**

Controller 7 (07h)	General volume, transposer 0 (00h) – 127 (7Fh).
Controller 11 (0Bh)	Expression pedals, transposer 0 (00Fh) – 127 (7Fh).

**Program Changes (transmitted/recognized)**

Organ stops: This depends on the number of stops and the sequence of stops.  
MIDI stops (programmable): 1-128

## System Exclusive Messages (transmitted/recognized)

Each 'sys ex' (system exclusive) message largely looks the same. The first 7 bytes and the last byte are always the same. Only the value of the 8th byte varies. This is the 'sys ex message' that Johannus generally uses: F0 00 4A 4F 48 41 53 XX F7 (hexadecimal).

Therefore, with the 'sys ex messages' described below, only the value of the 8th byte (XX) is given, and from which output it is transmitted.

### *All stops off*

The 'all stops off' sys ex code is 7F. This sys ex code is transmitted through the MIDI SEQ. output when the 0 piston is pressed for a long time.

When an 'all stops off' sys ex code is received, all stops on the instrument are switched off.

### *Thumb piston values*

When a piston is pressed, a sys ex code is transmitted with the value of the piston that is pressed (for example PP = 00 P = 01) through the MIDI MOD. output.

These sys ex codes are only important when the Johannus sound module CSM 128 is connected to your instrument.

### *Other MIDI codes (transmitted)*

Press the 0 piston to transmit the sys ex code, 'all stops off' and all volume settings through the MIDI SEQ. output.

### *Sys ex code stops (Program Changes)*

When a MIDI stop is switched on and off, besides the usual Program Change, an extra Program Change code (preceded by the sys ex code 3F) is transmitted through the MIDI SEQ. output. This is to distinguish between a 'normal' organ stop and a MIDI stop before transmitting a module.

When a stop is switched on and off, the following codes are transmitted:

Organ stop:	Through MIDI SEQ. :	CB XX
MIDI stop:	Through MIDI MOD. :	CX XX
	Through MIDI SEQ. :	CB XX and 3F CX XX

## WM-44 LDS SPECIFICATION

<b>Great</b>		<b>Swell</b>		<b>Pedal</b>	
Bourdon	16'	Gemshorn	16'	Contra Violone	32'
Open Diapason	8'	Diapason	8'	Open Diapason	16'
Stopped Flute	8'	Gedeckt	8'	Bourdon	16'
Claribel Flute	8'	Flute Celeste	8'	Echo Bourdon	16'
Gemshorn	8'	Viola di Gamba	8'	Octave	8'
Gemshorn Celeste	8'	Voix Celeste	8'	Bass Flute	8'
Octave	4'	Principal	4'	Choral Bass	4'
Harmonic Flute	4'	Chimney Flute	4'	Mixture	III
Octave Quint	2 2/3'	Aeoline Celeste II	4'	Contra Trombone	32'
Super Octave	2'	Nasard	2 2/3'	Trombone	16'
Full Mixture	IV	Piccolo	2'	Fagotto	16'
Cromorne	8'	Tierce	1 3/5'	Trumpet	8'
Posaune	8'	Mixture	IV	Clarion	4'
Chimes		Double Trumpet	16'	Great to Pedal	
Tremulant		Trumpet	8'	Swell to Pedal	
Swell to Great		Oboe	8'		
		English Horn	8'	Chorus	
		Clarion	4'	MIDI Great	
		Tuba	8'	MIDI Swell	
		Tremulant		MIDI Pedal	

### Specification

45 LDS Classic Voices  
 45 French Symphonic Voices  
 45 German Baroque Voices  
 45 Historic Voices  
 Orchestral: Chimes, Harp, Piano  
 100-level full capture system  
 10 generals / 6 per division  
 1 Tutti  
 General crescendo pedal  
 ASR-12 Acoustic Reverberation\*  
 3 programmable MIDI pistons  
 Melody coupler piston  
 Bass coupler piston  
 16-key transposer  
 Pitch control, +/- half step  
 General volume control\*  
 SET, +/- and Cancel pistons  
 Menu piston

### Technical Data

Audio 6.1 system:  
 7 amplifiers total 900 Watts  
 19 loudspeakers  
 7 speaker cabinets

Connections:  
 Headphone out  
 Stereo auxiliary in  
 Stereo auxiliary out  
 Stereo auxiliary out (XLR)  
 MIDI in, mod. (out), seq. (out)

Graphical display:  
 2 expression level indicators  
 General crescendo level  
 Pitch & transposer status  
 162-hymn player system  
 Prelude Player

### AGO Console

3 custom finishes:  
 - Dark Oak, LDS-95  
 - Medium Oak, LDS-110  
 - Cherry on Oak  
 Solid wooden console  
 32-note AGO pedalboard  
 2 x 61-note keyboards

Music rack with page holders

Adjustable bench

Intonat 5.128 Voicing Software

\* control accessible only to installer