

KAWAI

CL26 Owner's Manual

Preparation Before Use

Playing the Piano

Internal Songs

Settings

Appendix

Thank you for purchasing this Kawai digital piano.

This owner's manual contains important information regarding the usage and operation of the CL26 digital piano.

Please read all sections carefully, keeping this manual handy for future reference.

Preface

■ About this Owner's Manual

Before attempting to play this instrument, please read the **Preparation Before Use** section from page 10 of this owner's manual. This section explains the name and function of each part, how to connect the power cable, and how to turn on the power.

The **Playing the Piano** section (page 12) provides an overview of the instrument's most commonly used functions, allowing the CL26 digital piano to be enjoyed almost immediately after being connected, while the **Internal Songs** section (page 15) includes information regarding the built-in demonstration songs, and Concert Magic feature.

The **Settings** section (page 20) details the settings that can be used to adjust a number of sound and keyboard characteristics, and explains the instrument's basic MIDI functionality. Finally, the **Appendix** section (page 34) includes assembly and connectivity instructions, a troubleshooting guide, MIDI reference information, and full specification details.

■ CL26 Feature Highlights

Advanced Hammer Action IV-F weighted-key keyboard action

The *Advanced Hammer Action IV-F* (AHA IV-F) keyboard action has been developed to represent the distinctive touch of an acoustic grand piano, with its remarkable springless design providing consistent upward and downward motion for a smooth, natural, piano playing experience.

Moreover, just as acoustic pianos utilise heavier bass hammers and lighter treble hammers, the AHA IV-F keyboard action also employs different hammer weights, appropriately graded for each playing range. Such attention to detail allows greater stability during fortissimo passages, while preserving delicate pianissimo control, to satisfy the demands of even the most discerning pianist.

Harmonic Imaging™ (HI) sound technology, 88-key piano sampling

The CL26 digital piano captures the beautiful sound of Kawai's highly acclaimed hand-built concert grand piano, with all 88 keys of this exceptional instrument meticulously recorded, analysed and faithfully reproduced using proprietary *Harmonic Imaging™* technology. This unique process accurately recreates the broad dynamic range of the original grand piano, affording pianists an extraordinary level of expressiveness ranging from the softest pianissimo to the strongest, boldest fortissimo.

Additional reverberation effects that simulate the acoustic environment of a recital room, stage, or concert hall are also applied, resulting in a rich, vibrant piano tone that delivers breathtaking realism and authenticity.

Useful features, MIDI functionality

The CL26 offers a selection of useful digital piano features that further enhance one's musical enjoyment. Transpose and Tuning controls allow the pitch of the instrument to be conveniently adjusted, while Touch settings alter the keyboard's sensitivity to match different playing styles. The unique *Concert Magic* function encourages even non-players to enjoy making music, while standard MIDI connectivity ensures the CL26 can integrate with other digital audio hardware.

Compact cabinet, Slimline design

With elegant curves and graceful simplicity, the stylish CL26 cabinet represents another modern classic from Kawai's award winning design group. At under 27 cm deep, this ultra-compact digital piano occupies a minimal amount of floor space, while its fashionable wooden finishes blend effortlessly into today's modern living environments.

Important Safety Instructions

SAVE THESE INSTRUCTIONS

INSTRUCTIONS PERTAINING TO A RISK OF FIRE, ELECTRIC SHOCK, OR INJURY TO PERSONS



WARNING

TO REDUCE THE RISK OF FIRE OR ELECTRIC SHOCK, DO NOT EXPOSE THIS PRODUCT TO RAIN OR MOISTURE.

AVIS : RISQUE DE CHOC ELECTRIQUE - NE PAS OUVRIR.

TO REDUCE THE RISK OF ELECTRIC SHOCK, DO NOT REMOVE COVER (OR BACK). NO USER-SERVICEABLE PARTS INSIDE. REFER SERVICING TO QUALIFIED SERVICE PERSONNEL.



The lightning flash with arrowhead symbol, within an equilateral triangle, is intended to alert the user to the presence of uninsulated "dangerous voltage" within the product's enclosure that may be of sufficient magnitude to constitute a risk of electric shock to persons.



The exclamation point within an equilateral triangle is intended to alert the user to the presence of important operating and maintenance (servicing) instructions in the literature accompanying the product.

Examples of Picture Symbols



denotes that care should be taken.
The example instructs the user to take care not to allow fingers to be trapped.



denotes a prohibited operation.
The example instructs that disassembly of the product is prohibited.



denotes an operation that should be carried out.
The example instructs the user to remove the power cord plug from the AC outlet.

Read all the instructions before using the product.

- 1) Read these instructions.
- 2) Keep these instructions.
- 3) Heed all warnings.
- 4) Follow all instructions.
- 5) Do not use this apparatus near water.
- 6) Clean only with dry cloth.
- 7) Do not block any ventilation openings. Install in accordance with the manufacturer's instructions.
- 8) Do not install near any heat sources such as radiators, heat registers, stoves, or other apparatus (including amplifiers) that produce heat.
- 9) Do not defeat the safety purpose of the polarized or grounding-type plug. A polarized plug has two blades with one wider than the other. A grounding type plug has two blades and a third grounding prong. The wide blade or the third prongs are provided for your safety. If the provided plug does not fit into your outlet, consult an electrician for replacement of the obsolete outlet.
- 10) Protect the power cord from being walked on or pinched particularly at plugs, convenience receptacles, and the point where they exit from the apparatus.
- 11) Only use attachments/accessories specified by the manufacturer.
- 12) Use only with the cart, stand, tripod, bracket, or table specified by the manufacturer, or sold with the apparatus. When a cart is used, use caution when moving the cart/apparatus combination to avoid injury from tip-over. 
- 13) Unplug this apparatus during lightning storms or when unused for long periods of time.
- 14) Refer all servicing to qualified service personnel. Servicing is required when the apparatus has been damaged in any way, such as power-supply cord or plug is damaged, liquid has been spilled or object have fallen into the apparatus, the apparatus has been exposed to rain or moisture, does not operate normally, or has been dropped.

WARNING - When using electric products, basic precautions should always be followed, including the following.



WARNING

Indicates a potential hazard that could result in death or serious injury if the product is handled incorrectly.

The product should be connected to an AC outlet of the specified voltage.



- If you are going to use an AC power cord, make sure that its has the correct plug shape and conforms to the specified power voltage.
- Failure to do so may result in fire.

Do not insert or disconnect the power cord plug with wet hands.



Doing so may cause electric shock.

Take care not to allow any foreign matter to enter the product.

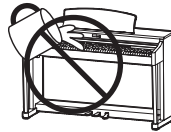

Entry of water, needles or hair pins may result in breakdown or short-circuit. The product shall not be exposed to dripping or splashing. No objects filled with liquids, such as vases, shall be placed on the product.

The chair must be used properly (it must be used only when playing the product).

- Do not play with it or stand on it.
- Only one person is allowed to sit on it.
- Do not sit on it when opening the lid.
- Re-tighten the bolts occasionally.

Doing so may cause the chair to fall over or your fingers to be trapped, resulting in injury.

When using the headphones, do not listen for long periods of time at high volume levels.

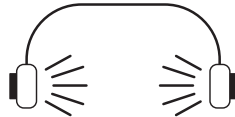

Doing so may result in hearing problems.

Do not lean against the keyboard.

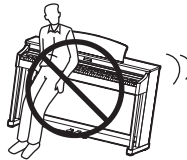

Doing so may cause the product to fall over, resulting in injury.

Do not disassemble, repair or modify the product.

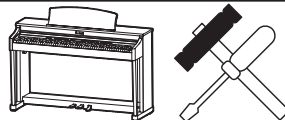

Doing so may result in product breakdown, electric shock or short-circuit.

When disconnecting the AC power cord's plug, always hold the plug and pull it to remove it.



- Pulling the AC power cord itself may damage the cord, causing a fire, electric shock or short-circuit.

The product is not completely disconnected from the power supply even when the power switch is turned off. If the product will not be used for a long time, unplug the AC power cord from the AC outlet.



- Failure to do so may cause fire in case of lightning.
- Failure to do so may over-heat the product, resulting in fire.

This product may be equipped with a polarized line plug (one blade wider than the other). This is a safety feature. If you are unable to insert the plug into the outlet, contact an electrician to replace your obsolete outlet. Do not defeat the safety purpose of the plug.

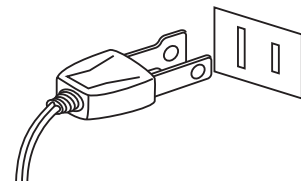

This product shall be near the AC outlet and the power cord plug in a position so that it can readily be disconnected in an emergency because electricity is always charging while the plug is in the AC outlet even in a power switch off condition.



CAUTION

Indicates a potential hazard that could result in injury or damage to the product or other property if the product is handled incorrectly.

Do not use the product in the following areas.

- Areas, such as those near windows, where the product is exposed to direct sunlight
- Extremely hot areas, such as near a heater
- Extremely cold areas, such as outside
- Extremely humid areas
- Areas where a large amount of sand or dust is present
- Areas where the product is exposed to excessive vibrations

Using the product in such areas may result in product breakdown. Use the product only in moderate climates (not in tropical climates).

When you close the keyboard cover, close it gently.



Closing it roughly may trap your fingers, resulting in injury.

Before connecting cords, make sure that the power to this product and other devices is turned OFF.

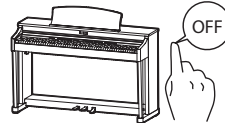

Failure to do so may cause breakdown of this product and other devices.

Do not drag the product on the floor. Take care not to drop the product.

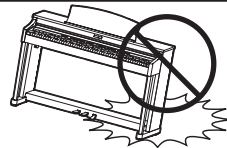

Please lift up the product when moving it. Please note that the product is heavy and must be carried by more than two persons. Dropping the product may result in breakdown.

Do not place the product near electrical appliances such as TVs and radios.

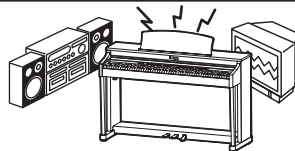

- Doing so may cause the product to generate noise.
- If the product generates noise, move the product sufficiently away from the electrical appliance or connect it to another AC outlet.

When connecting the AC power cord and other cords, take care not to get them tangled.



Failure to do so may damage them, resulting in fire, electric shock or short-circuit.

Do not wipe the product with benzene or thinner.



- Doing so may result in discoloration or deformation of the product.
- When cleaning the product, put a soft cloth in lukewarm water, squeeze it well, then wipe the product.

Do not stand on the product or exert excessive force.



- Doing so may cause the product to become deformed or fall over, resulting in breakdown or injury.

Do not place naked flame, such as lighted candles on the product.

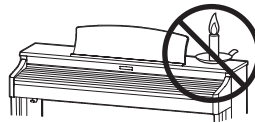

Doing so may cause the illumination to fall over, resulting in fire.

Ensure that the ventilation is not impeded by covering the ventilation openings with items, such as newspaper, table-cloths, curtains, etc.

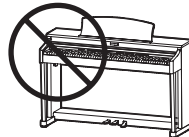

Failure to do so may over-heat the product, resulting in fire.

The product should be located so that its location or position does not interfere with its proper ventilation. Ensure a minimum distance of 5cm around the product for sufficient ventilation.

The product should be serviced by qualified service personnel when:

- The power supply cord or the plug has been damaged.
- Objects have fallen, or liquid has been spilled into the product.
- The product has been exposed to rain.
- The product does not appear to operate normally or exhibits a marked change in performance.
- The product has been dropped, or the enclosure damaged.

Notes on Repair

Should an abnormality occur in the product, immediately turn the power OFF, disconnect the power cord plug, and then contact the shop from which the product was purchased.

Instruction for AC power cord (U.K.)

IMPORTANT: THE WIRES IN THIS MAINS LEAD ARE COLOURED IN ACCORDANCE WITH THE FOLLOWING CODE:

- BLUE: NEUTRAL
- BROWN: LIVE

As the colours of the wires in the mains lead of this apparatus may not correspond with the coloured markings identifying the terminals in your plug, proceed as follows.

- The wire which is coloured BLUE must be connected to the terminal which is marked with the letter N or coloured BLACK.
- The wire which is coloured BROWN must be connected to the terminal which is marked with the letter L or coloured RED.
- Do not plug either terminal of the power cord to the the ground of AC outlet on the wall.



An information on Disposal for users

If your product is marked with this recycling symbol it means that, at the end of its life, you must dispose of it separately by taking it to an appropriate collection point. You should not mix it with general household waste. Disposing of this product correctly will prevent potential negative effects on the environment and human health which could otherwise arise due to inappropriate waste handling. For further details, please contact your local authority. (European Union only)

Canadian Radio Interference Regulations

This instrument complies with the limits for a class B digital apparatus, pursuant to the Radio Interference Regulations, C.R.C., c.1374.

FCC Information (U.S.A)

CAUTION: Changes or modifications not expressly approved by the party responsible for compliance could void the user's authority to operate the equipment.

NOTE: This equipment has been tested and found to comply with the limits for a Class B digital device, pursuant to Part 15 of the FCC Rules. These limits are designed to provide reasonable protection against harmful interference in a residential installation. This equipment generates, uses and can radiate radio frequency energy and, if not installed and used in accordance with the instructions, may cause harmful interference to radio communications. However, there is no guarantee that interference will not occur in a particular installation. If this equipment does cause harmful interference to radio or television reception, which can be determined by turning the equipment off and on, the user is encouraged to try to correct the interference by one or more of the following measures:

- Reorient or relocate the receiving antenna.
- Increase the separation between the equipment and receiver.
- Connect the equipment into an outlet on a circuit different from that to which the receiver is connected.
- Consult the dealer or an experienced radio/TV technician for help.

The nameplate label is located on the underside of the instrument, as indicated below.

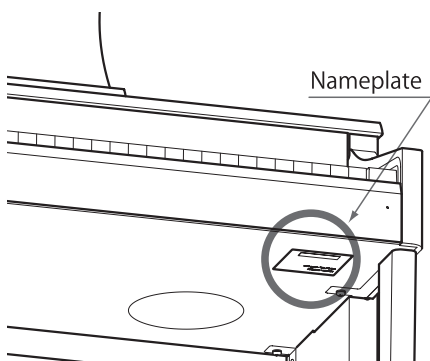

Table of Contents

Preface	3
Important Safety Instructions	4
Table of Contents	9

Preparation Before Use

Part Names and Functions	10
Setting Up the Piano	11

Playing the Piano

Selecting Sounds	12
Dual Mode	13
Metronome	14

Internal Songs

Demo Songs	15
Concert Magic	16
Concert Magic demo modes	17
Concert Magic song arrangement types	18
Concert Magic song list	19

Settings

Keyboard and Sound Settings	20
1. Touch	21
2. Transpose	22
3. Tuning	23
4. Reverb	24
5. Concert Magic Mode	25

MIDI Settings	26
MIDI Overview	26
1. MIDI Channel	28
2. Local Control	29
3. Multi-timbral Mode	30
4. Transmit MIDI Program Change	31
Program Change Number List	32

Power Settings	33
1. Auto Power Off	33

Appendix

Assembly Instructions	34
Connecting to Other Devices	36
Troubleshooting	36
Specifications	37
MIDI Implementation Chart	38

Part Names and Functions

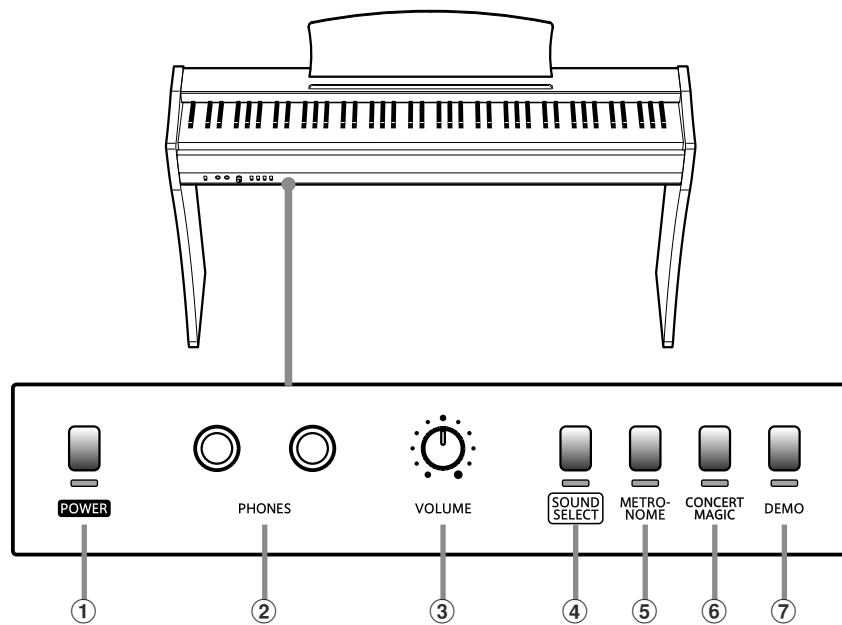

① POWER button

This button is used to turn the CL26 digital piano on/off. Be sure to turn off the instrument after playing.

② PHONES jacks

These jacks are used to connect stereo headphones to the CL26 digital piano. Two pairs of headphones can be connected and used simultaneously.

③ VOLUME knob

This knob is used to adjust the volume level of the CL26 digital piano's built-in speakers or headphones, if connected.

④ SOUND SELECT button

This button is used to select the sound(s) that will be heard when the keys are pressed.

⑤ METRONOME button

This button is used to turn the metronome function on/off, and also to adjust the tempo and time signature settings.

⑥ CONCERT MAGIC button

This button is used to select the desired Concert Magic song.

⑦ DEMO button

This button is used to start/stop playback of the CL26 digital piano's built-in Demonstration and Concert Magic songs.

■ Function Labels

The three function labels included with the CL26 digital piano provide a convenient reference for the instrument's various functions and can be attached to either the front or the back of the keyboard.

Position the function label so that the left end marked 'PIANO 1' is aligned with the lowest key (A-1). Next, position the second function label beside the first, so that the left end marked 'TOUCH' is aligned with the second 'F' key (F1). Finally, position the third, smaller label so that 'AUTO POWER OFF' is aligned with the highest key (C7).

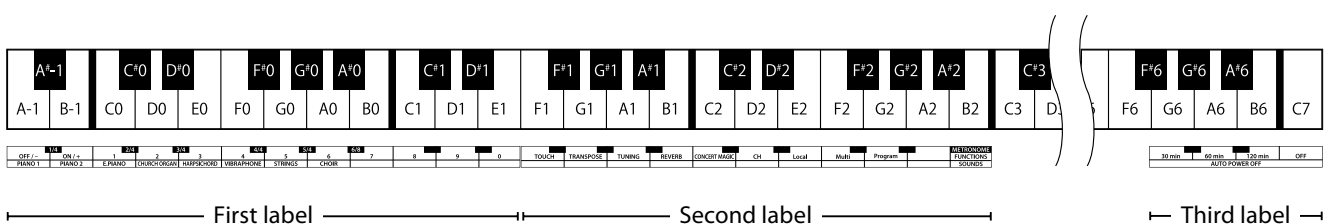

Setting Up the Piano

1. Connecting the power adaptor and pedal unit

Connect the included AC power adaptor and F-10H pedal unit to the 'DC IN' and 'PEDAL' jacks located on the underside of the instrument, as indicated below.

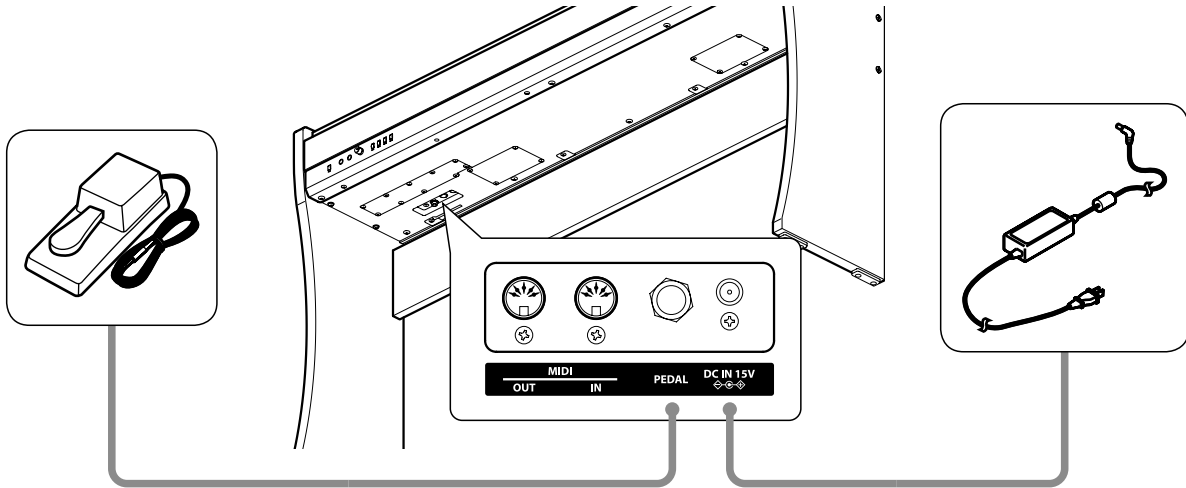

2. Connecting the power adaptor to an outlet

Connect the AC power adaptor to an AC outlet.

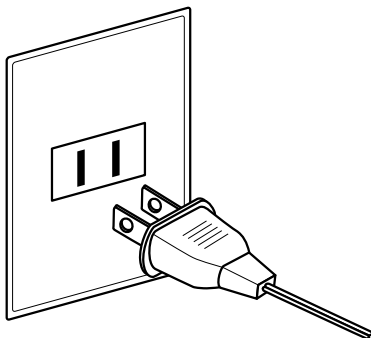

3. Turning on the power

Press the POWER button located on the left hand side of the instrument's front panel. The LED indicators for the POWER and SOUND SELECT buttons will turn on and the Concert Grand sound will be selected automatically.

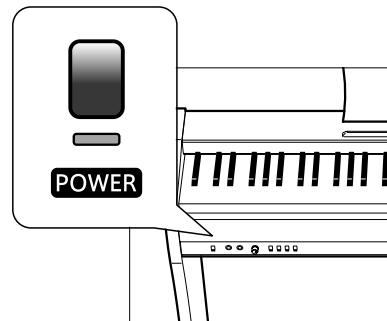

* The CL26 features a power saving function that can automatically turn off the instrument after a specified period of inactivity. For more information, please refer to the Auto Power Off setting on page 33.

4. Adjusting the volume

Turn the VOLUME knob clockwise or anti-clockwise to increase or decrease the volume level of the instrument's speakers, or headphones if connected.

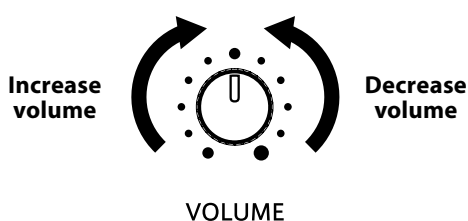

Adjust the volume to a comfortable listening level - the middle is often a good starting point.

■ Using headphones

Use the jacks located beneath the keyboard on the left hand side, to connect stereo headphones to the instrument.

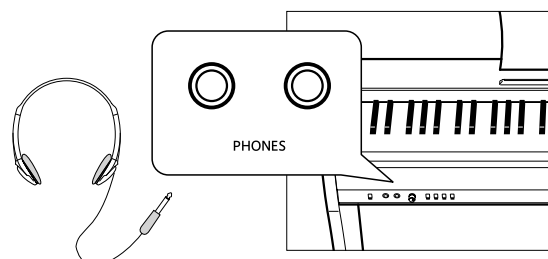

When a pair of headphones is connected, sound will not be produced by the speakers.

Selecting Sounds

The CL26 digital piano features 8 different instrument sounds, which can be selected in one of two ways. By default the 'Concert Grand' sound will be selected automatically when the instrument is turned on.

Instrument Sounds

Sound name	Description	Key
Concert Grand	A concert grand piano with a rich, expansive tone.	A-1
Studio Grand	A grand piano with a brightly voiced tone.	B-1
Electric Piano	A vintage electric piano.	C0
Church Organ	A traditional pipe organ.	D0
Harpichord	A baroque period plucked instrument.	E0
Vibraphone	A percussive, tuned instrument played using mallets.	F0
Strings	A string ensemble.	G0
Choir	An ensemble of singing voices.	A0

Selecting a sound: Method 1

Press the SOUND SELECT button repeatedly to cycle through the 8 available instrument sounds.

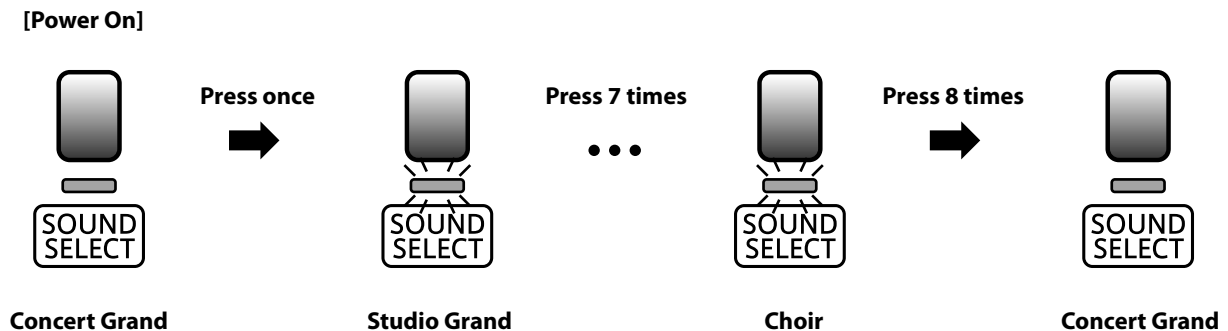

* When the Concert Grand sound is selected, the LED indicator for the SOUND SELECT button will turn on. When a sound other than Concert Grand is selected, the LED indicator for the SOUND SELECT button will start to flash.

Selecting a sound: Method 2

Press and hold the SOUND SELECT button, then press one of the lowest eight white keys to selected the desired instrument sound.

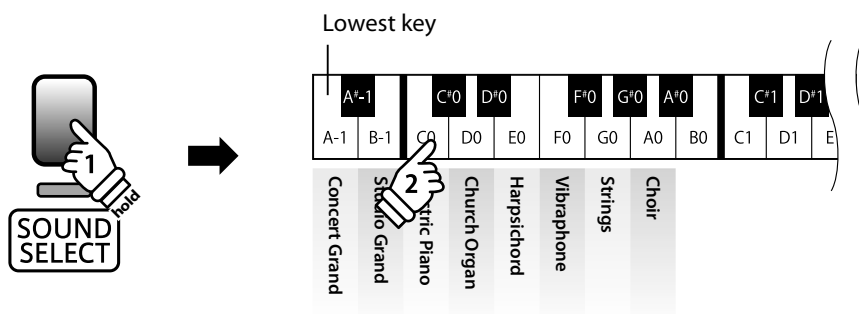

* To return to the Concert Grand sound immediately, press and hold the SOUND SELECT button for more than one second.

Dual Mode

The Dual Mode function allows two sounds to be layered together, creating a more complex sound. For example, a piano sound layered with strings, or an electric piano combined with a harpsichord, etc.

■ Enabling Dual Mode

Press and hold the SOUND SELECT button, then press two of the lowest eight keys simultaneously.

The sounds corresponding to the two keys will be layered together.

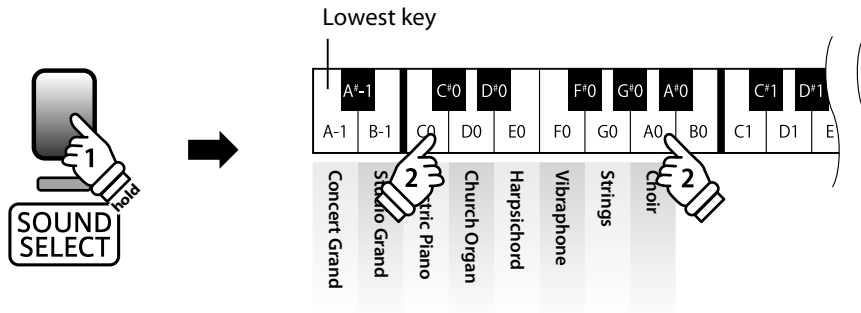

■ Exiting Dual Mode

Press the SOUND SELECT button.

The Concert Grand sound will be selected automatically and the instrument will return to normal operation.

Metronome

The Metronome function provides a steady beat to aid practicing the piano at a consistent tempo. The time signature and tempo of the metronome can be freely adjusted.

■ Turning the metronome on/off

Press the METRONOME button.

The metronome will start to count and the LED indicator for the METRONOME button will turn on, indicating that the metronome is in use.



* By default the metronome will count with a 1/4 beat at 120 bpm.

Press the METRONOME button again to stop the metronome.

■ Changing the metronome time signature

Press and hold the METRONOME button, then press one of the 6 lowest black keys, as shown in the illustration below.

* The metronome can be set to one of six time signatures: 1/4, 2/4, 3/4, 4/4, 5/4, and 6/8.

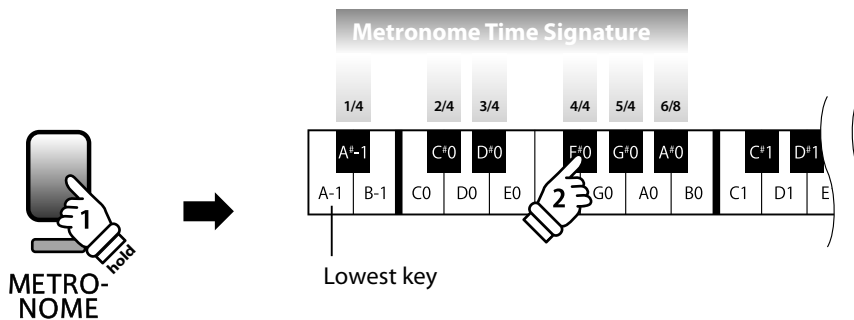

■ Adjusting the metronome tempo

Press and hold the METRONOME button, enter the desired tempo using the lowest 12 white keys marked below, then release the METRONOME button.

* The metronome tempo can be adjusted within the range of 10-300 bpm.

* The metronome tempo can be entered precisely, or decreased and increased gradually.

Method 1:

While pressing the METRONOME button, press keys 1, 5, and 0 to set the tempo to 150 bpm, or keys 8 and 5 to set the tempo to 85 bpm.

Method 2:

While pressing the METRONOME button, press the - / + keys to gradually decrease or increase the tempo in 2 bpm increments.

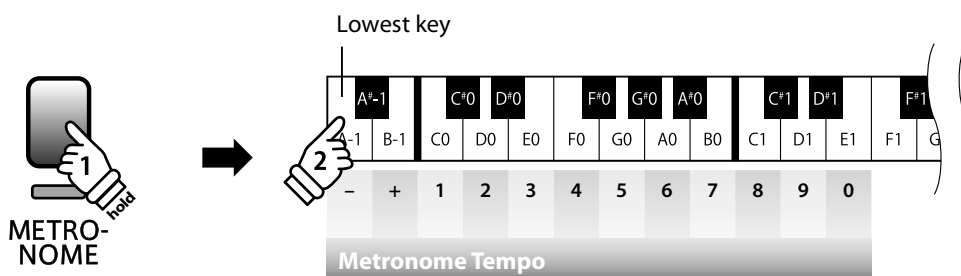

Demo Songs

The CL26 digital piano includes a selection of demonstration songs to introduce each internal sound.

■ Demo songs

Sound name	Song name	Composer
Concert Grand	Golliwogg's Cakewalk	Debussy
Studio Grand	Kawai original	Kawai
Electric Piano	Kawai original	Kawai
Church Organ	Toccata	Eugene Gigout
Harpichord	French Suite No.6	Bach
Vibraphone	Kawai original	Kawai
Strings	Le quattoro stagioni "La Primavera"	Vivaldi
Choir	Kawai original	Kawai

* Kawai regrets that sheet music for Kawai original demo songs is not available.

1. Playing the demo songs

Press the DEMO button.

The LED indicator for the DEMO button will start to flash and the Concert Grand demo song will start to play.

* When the Concert Grand demo song has finished, another demo song will be selected at random. This process will continue until all of the demo songs have been played.



Press the DEMO button again to stop the demo.

2. Selecting a demo song to play

While the demo is playing:

Press and hold the SOUND SELECT button, then press the white key assigned to the desired demo song.

* It is also possible to skip to the next demo song by pressing the SOUND SELECT button while the demo is playing.

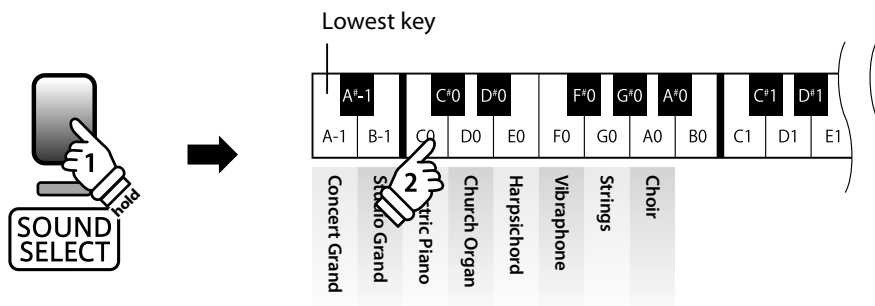

Concert Magic

The Concert Magic function allows complete beginners to enjoy playing the piano by simply selecting one of the 40 pre-programmed songs, then tapping the keyboard with a steady rhythm and tempo.

The Concert Magic songs are categorised by group and assigned to the lowest 40 white keys of the keyboard. For a complete listing of available Concert Magic songs, please refer to page 19 of this owner's manual.

1. Selecting a Concert Magic song

Press and hold the CONCERT MAGIC button, then press the white key assigned to the desired Concert Magic song.

The LED indicator for the CONCERT MAGIC button will turn on, indicating that Concert Magic playing mode is in use.

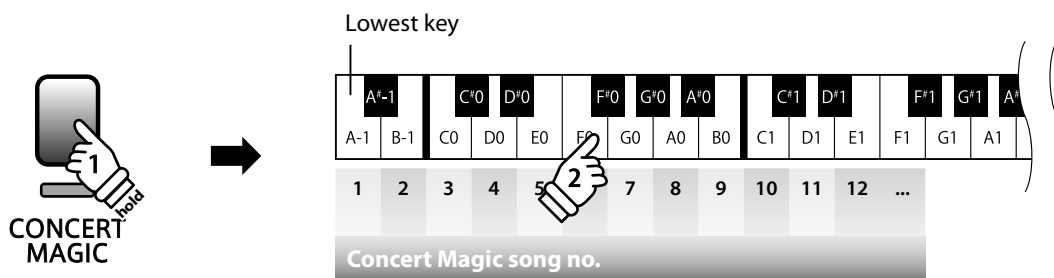

2. Listening to the selected Concert Magic song

Press the DEMO button.

The LED indicator for the DEMO button will turn on and the selected Concert Magic song will start to play.

* To listen to a different Concert Magic song simply repeat step 1 above.

Press either the CONCERT MAGIC or DEMO buttons again to stop the song.



DEMO

3. Performing the selected Concert Magic song

Press keys on the keyboard.

The song will advance with every key that is pressed.

Pressing the keys gently will produce a soft sound, while pressing heavily will produce a loud sound.

Similarly, pressing the keys quickly will increase the tempo of the song, while pressing slowly will decrease the tempo.

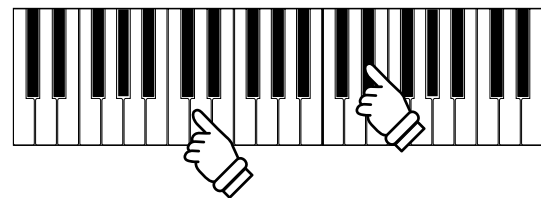

■ Exiting Concert Magic playing mode

Press the CONCERT MAGIC button.

The LED indicator for the CONCERT MAGIC button will turn off and the keyboard will return to normal operation.



CONCERT
MAGIC

Concert Magic demo modes

The Concert Magic demo modes allow the Concert Magic songs to be listened to in one of three ways: All Play, Category Play, and One Song Play

■ All Play

Press the CONCERT MAGIC button, then press the DEMO button.

The LED indicator for the DEMO button will turn on and the Concert Magic songs will start to play in numerical order.

Press either the CONCERT MAGIC or DEMO buttons again to stop song playback.

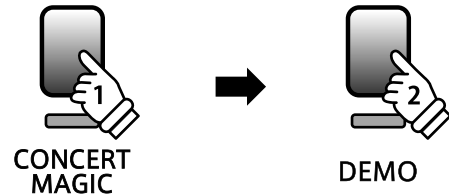

■ Category Play

Press and hold the CONCERT MAGIC button, then press the white key assigned to the desired Concert Magic song. While still holding the CONCERT MAGIC button, press the DEMO button.

The LED indicator for the DEMO button will turn on and the selected Concert Magic song will start to play. When the selected song finishes, the next song in the same category will start to play automatically.

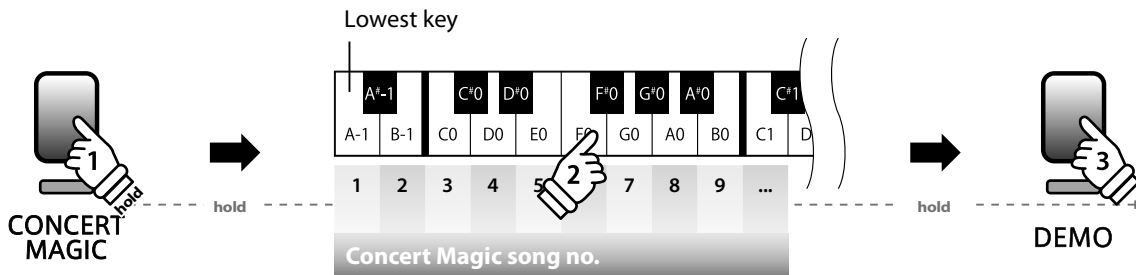

■ One Song Play

Press and hold the CONCERT MAGIC button, then press the white key assigned to the desired Concert Magic song. Release the CONCERT MAGIC button, then press the DEMO button.

The LED indicator for the DEMO button will turn on and the selected Concert Magic song will start to play. The selected song will play continuously until the CONCERT MAGIC or DEMO buttons are pressed again to stop song playback.

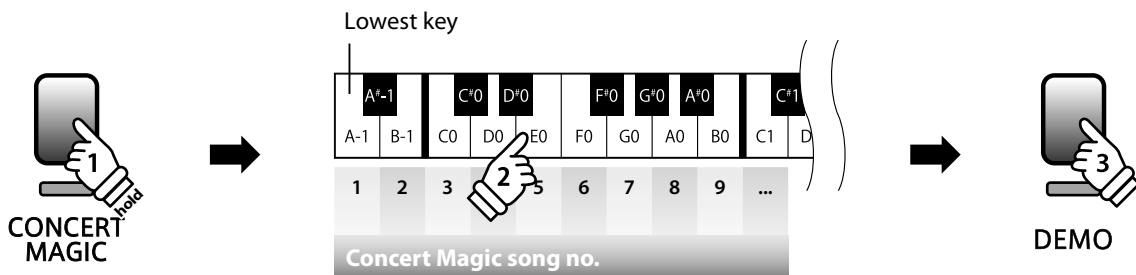

Concert Magic song arrangement types

Concert Magic songs are divided into three different arrangement types: Easy Beat (EB), Melody Play (MP), and Skillful (SK). Each arrangement type requires a different level of skill to be performed correctly.

Easy Beat

EB

These are the easiest songs to play. To perform them, simply tap out a constant, steady beat on any key of the keyboard. For example, when playing the piece 'Für Elise', a constant, steady rhythm should to be maintained throughout the song.

Key on: X X X X X X X X X X X X X X X X X X X X X X

Melody Play

MP

These songs are also relatively easy to play, especially if they are familiar to the player. To perform them, tap out the rhythm of the melody on any key of the keyboard. Singing along as the rhythm is tapped can be helpful.

For example, when playing the piece 'Twinkle, Twinkle, Little Star', the rhythm of the melody should be played.

* When performing fast Concert Magic songs, it may be easier to press different keys with two alternating fingers in order to achieve greater speed.

Key on: X X X X X X X X X X X X X X X

Skillful

SK

These songs range in difficulty from moderately difficult to difficult. To perform them, tap out the rhythm of both the melody and the accompaniment notes on any key of the keyboard.

For example, when playing the piece 'Waltz of the Flowers', the rhythm of both the melody and the accompaniment should be played.

Key on: X X X X X X X X X X X X X

Concert Magic song list

No.	Song Name	Type
Children's Songs		
1	Twinkle, Twinkle, Little Star	MP
2	I'm A Little Teapot	MP
3	Mary Had A Little Lamb	MP
4	London Bridge	MP
5	Row, Row, Row Your Boat	MP
6	Frère Jaques	MP
7	Old MacDonald Had A Farm	MP
Christmas Songs		
8	Hark The Herald Angels Sing	MP
9	Jingle Bells	MP
10	Deck The Halls	MP
11	O Come All Ye Faithful	MP
12	Joy To The World	MP
13	Silent Night	MP
14	We Wish You A Merry Christmas	MP
American Classics		
15	Battle Hymn Of The Republic	MP
16	Yankee Doodle	MP
17	Danny Boy	EB
18	Clementine	MP
19	Auld Lang Syne	MP
20	Oh Susanna	SK
21	Camptown Races	MP
22	When The Saints Go Marching In	EB
23	The Entertainer	SK

No.	Song Name	Type
Classical Selections		
24	William Tell Overture	SK
25	Andante (Haydn)	MP
26	Für Elise	EB
27	Clair De Lune	SK
28	Skater's Waltz	SK
29	Blue Danube Waltz	SK
30	Gavotte (Gossec)	SK
31	Waltz Of The Flowers	SK
Special Occasions		
32	Bridal Chorus	MP
33	Wedding March	SK
34	Pomp And Circumstance	SK
International Songs		
35	When Irish Eyes Are Smiling	EB
36	Chiapenacas	SK
37	Santa Lucia	SK
38	Funicli Funicla	SK
39	Romance De L'amour	EB
40	My Wild Irish Rose	EB

Keyboard and Sound Settings

The CL26's keyboard and sound settings allow various aspects of the instrument to be adjusted. When the instrument is turned on, these settings will return to the default values indicated below.

Keyboard and Sound Settings

Setting name	Explanation	Default setting
Touch	Change the touch sensitivity of the keyboard.	Normal
Transpose	Increase or decrease the pitch of the keyboard in semi-tone steps.	0
Tuning	Increase or decrease the pitch of the keyboard in 0.5 Hz steps.	A4 = 440.0 Hz
Reverb	Change the type of reverberation added to the sound.	Room
Concert Magic Mode	Change the Concert Magic playing mode	Normal

Changing settings

Press and hold the METRONOME and CONCERT MAGIC buttons simultaneously, then press the key assigned to the desired setting.

While still holding the METRONOME and CONCERT MAGIC buttons, press the key assigned to the desired setting's value/type. The selected settings will be applied immediately.

* It is possible to adjust multiple settings while holding the METRONOME and CONCERT MAGIC buttons.

* Use the included Function Labels (page 10) to reference the CL26's keyboard and sound settings more conveniently.

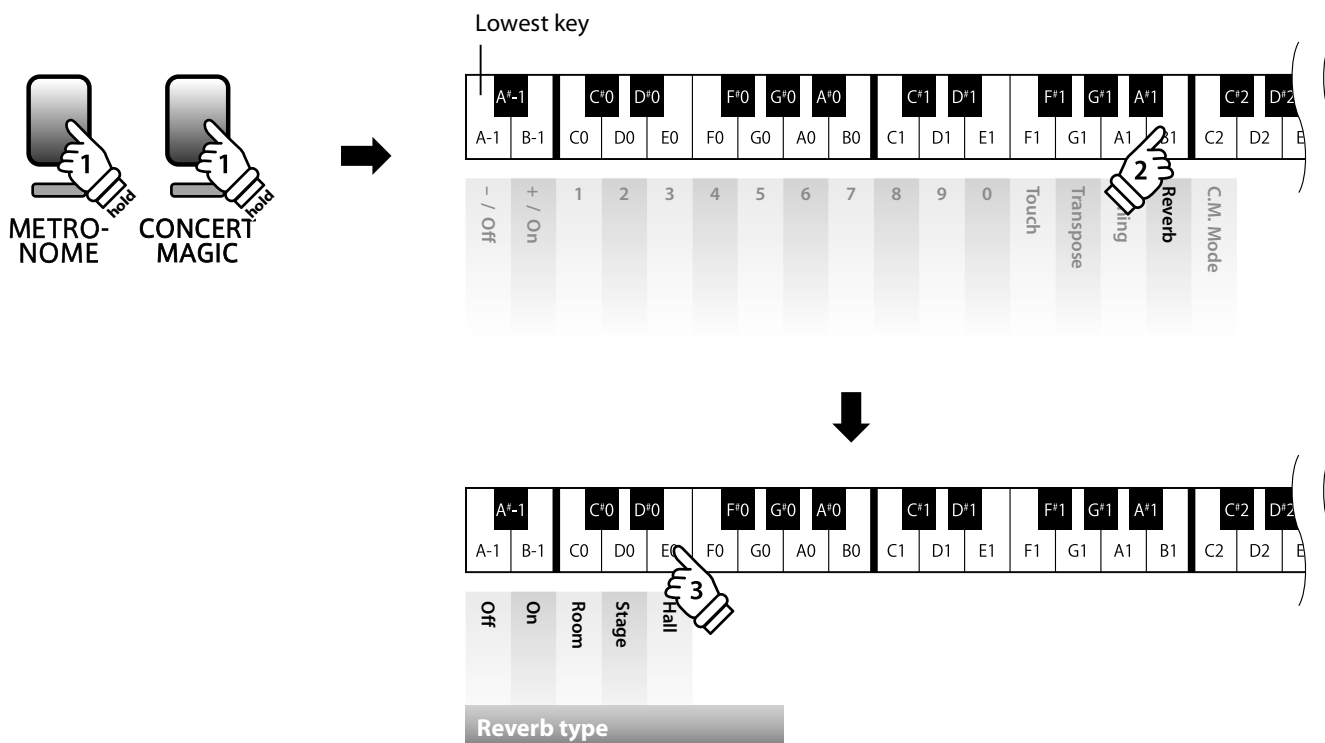

1 Touch

As with an acoustic piano, the CL26 digital piano produces a louder sound when the keys are struck with force, and a softer sound when the keys are played gently. The volume and tonal character change in relation to the strength and speed of playing - on a digital piano this system is referred to as 'touch sensitivity'.

The Touch setting allows the touch sensitivity of the keyboard to be conveniently adjusted. There are four different preset touch settings available.

■ Touch type

Touch type	Description	Key
Light	A louder volume is produced even when playing with a soft touch. This setting is recommended for children and organ players, or for those still developing finger strength.	C0
Normal (default)	Reproduces the standard touch sensitivity of an acoustic piano.	D0
Heavy	Requires a heavier touch to produce a loud volume. This setting is recommended for players with stronger fingers.	E0
Constant	A constant volume is produced regardless of how hard the keys are struck. This setting is recommended for sounds that have a fixed dynamic range such as organ and harpsichord.	F0

■ Changing the Touch type

Press and hold the METRONOME and CONCERT MAGIC buttons simultaneously, then press the F1 key to select the Touch setting.

While still holding the METRONOME and CONCERT MAGIC buttons, press the key assigned to the desired Touch type. The selected Touch type will be applied immediately.

* When the instrument is turned on, the Touch setting will return to the default type of 'Normal'.

* Use the included Function Labels (page 10) to reference the CL26's keyboard and sound settings more conveniently.

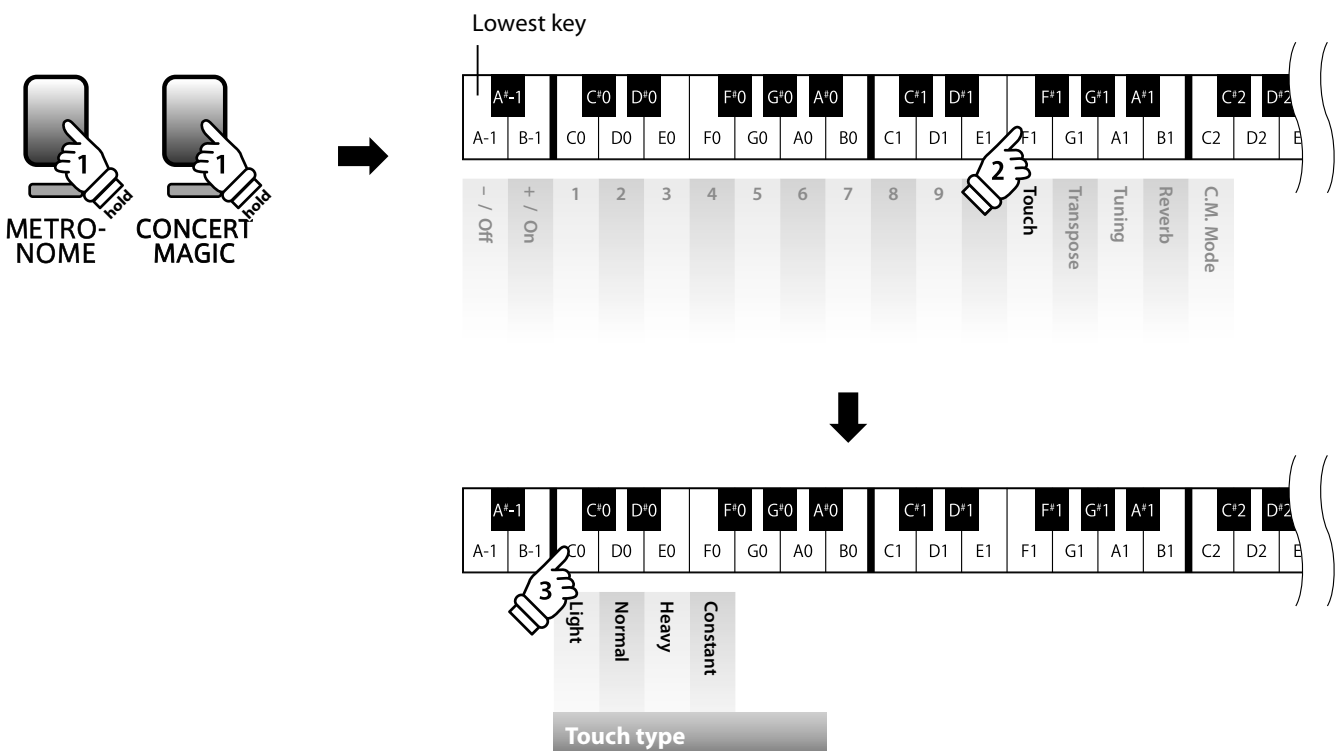

2 Transpose

The Transpose setting allows the pitch of the CL26 digital piano keyboard to be raised or lowered in semi-tone steps. This is particularly useful when accompanying instruments with different tones, or when a song learned in one key must be played in another key. When transposed, the song can be played in the original key, yet heard in a different key.

■ Adjusting the Transpose setting

Press and hold the METRONOME and CONCERT MAGIC buttons simultaneously, then press the G1 key to select the Transpose setting.

While still holding the METRONOME and CONCERT MAGIC buttons, press the key assigned to the desired Transpose value. The adjusted Transpose setting will be applied immediately.

The 'Off' and 'On' keys can also be used to disable/enable the Transpose setting while retaining the specified value.

- * The Transpose setting can be adjusted up to +5 semitones higher (key of F) or -6 semitones lower (key of F[♯]).
- * When the instrument is turned on, the Transpose setting will return to the default value of '0' (C).
- * Use the included Function Labels (page 10) to reference the CL26's keyboard and sound settings more conveniently.

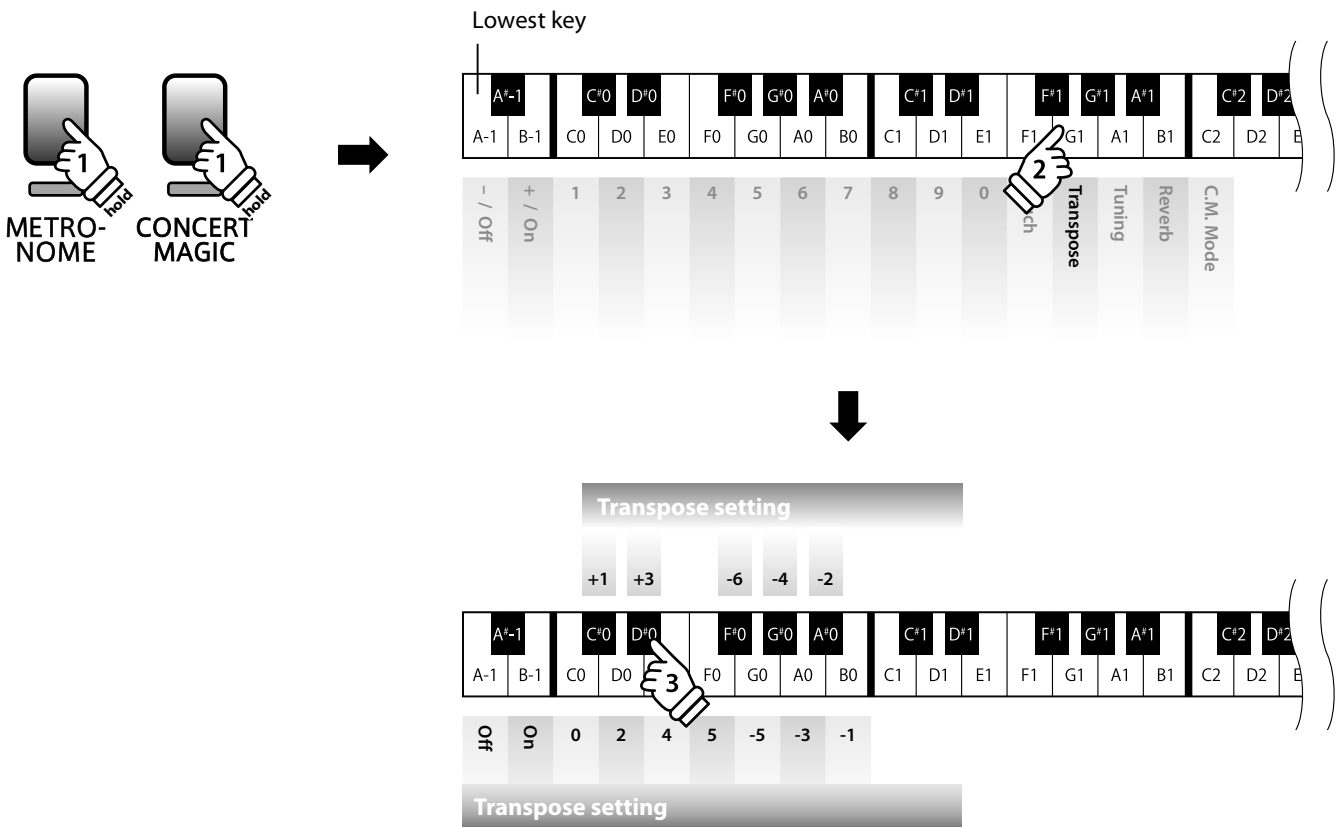

3 Tuning

The Tuning setting allows the overall pitch of the CL26 digital piano to be raised and lowered in 0.5 Hz steps, and may therefore prove useful when playing with other instruments.

■ Adjusting the Tuning setting

Press and hold the METRONOME and CONCERT MAGIC buttons simultaneously, then press the A1 key to select the Tuning setting.

While still holding the METRONOME and CONCERT MAGIC buttons, input the desired pitch using the number keys indicated below.

The '-' and '+' keys can also be used to lower/raise the pitch in 0.5 Hz steps.

The adjusted Tuning setting will be applied immediately.

* The Tuning setting can be adjusted within the range of 427 - 453 Hz.

* When the instrument is turned on, the Tuning setting will return to the default value of 'A4=440'.

* Use the included Function Labels (page 10) to reference the CL26's keyboard and sound settings more conveniently.

The diagram illustrates the process of adjusting the tuning setting. It starts with two buttons: METRONOME and CONCERT MAGIC, each with a '1' and 'hold' icon. An arrow points to a keyboard diagram with function labels. A hand icon with '2' points to the 'Tuning' label on the keyboard. A downward arrow points to a second keyboard diagram where a hand icon with '6' points to the '+' key, a hand icon with '4' points to the '3' key, a hand icon with '3' points to the '4' key, and a hand icon with '5' points to the '0' key. Below this keyboard, a grey bar displays 'Tuning setting'.

Example: A4=430.5 Hz
Enter 4, 3, 0, then press the + key.

4 Reverb

The Reverb setting adds reverberation to the sound, simulating the acoustic environment of a recital room, stage, or concert hall. The most suitable reverb type is applied automatically when selecting each sound, however it is also possible to select a different reverb type manually if desired.

■ Reverb type

Reverb type	Description	Key
Room (default for Concert Grand)	Simulates the ambiance of a living room or small rehearsal room.	C0
Stage	Simulates the ambiance of a small hall or live stage.	D0
Hall	Simulates the ambiance of a concert hall or theater.	E0
Off	Disables the reverb effect.	A-1
On	(Re)Enables the reverb effect.	B-1

■ Changing the Reverb type

Press and hold the METRONOME and CONCERT MAGIC buttons simultaneously, then press the B1 key to select the Reverb setting.

While still holding the METRONOME and CONCERT MAGIC buttons, press the key assigned to the desired Reverb type. The selected Reverb type will be applied immediately.

The 'Off' and 'On' keys can also be used to disable/enable the Reverb setting while retaining the specified type.

* When the instrument is turned on, the Reverb setting will return to the default type of 'Room'.

* Use the included Function Labels (page 10) to reference the CL26's keyboard and sound settings more conveniently.

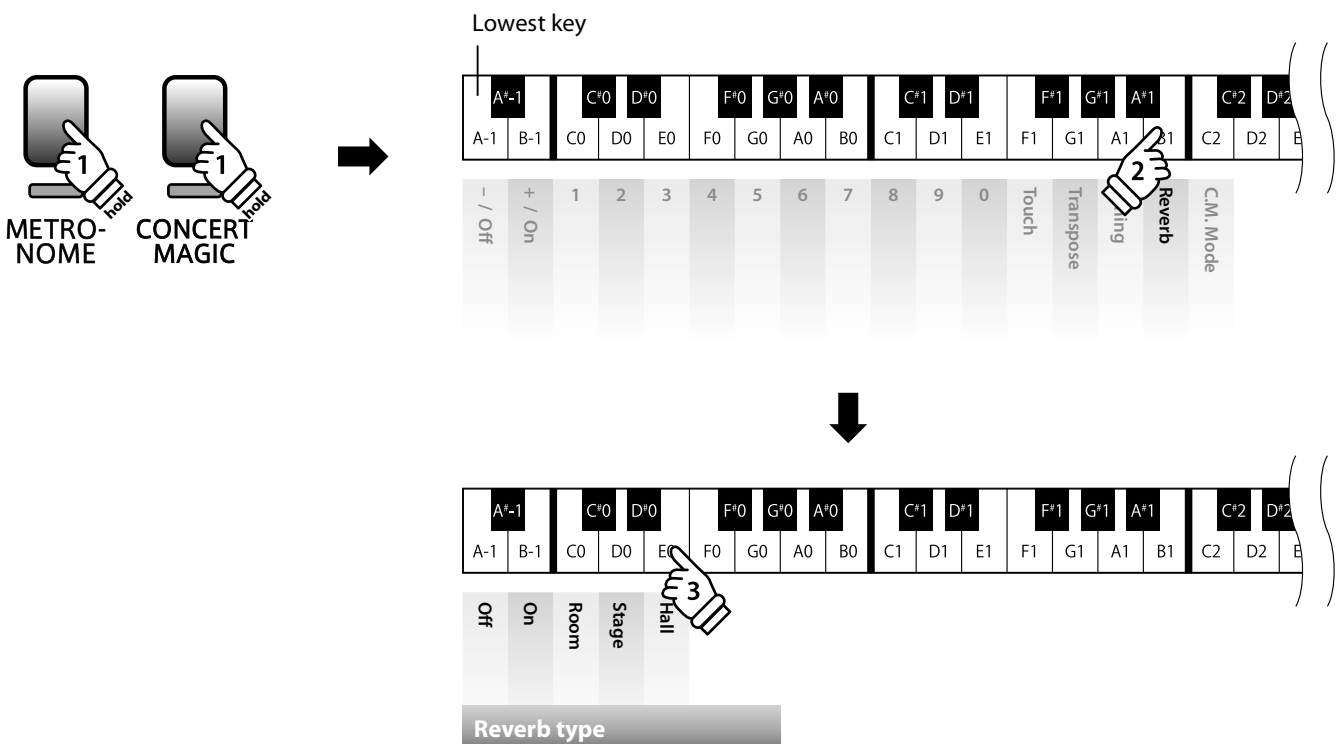

5 Concert Magic Mode

The Concert Magic Mode setting changes the Concert Magic playing mode, allowing all Concert Magic songs to be played by simply tapping any key with a constant steady beat, regardless of the song arrangement type.

■ Concert Magic Mode

Concert Magic Mode	Description	Key
Normal	Concert Magic songs will be performed according to their arrangement type.	A-1
Steady Beat	All Concert Magic songs will be performed by tapping the key with a constant beat.	B-1

■ Changing the Concert Magic Mode

Press and hold the METRONOME and CONCERT MAGIC buttons simultaneously, then press the C2 key to select the Concert Magic Mode setting.

While still holding the METRONOME and CONCERT MAGIC buttons, press the key assigned to the desired Concert Magic Mode. The selected Concert Magic Mode type will be applied immediately.

- * When the instrument is turned on, the Concert Magic Mode setting will return to the default type of 'Normal'.
- * Use the included Function Labels (page 10) to reference the CL26's keyboard and sound settings more conveniently.

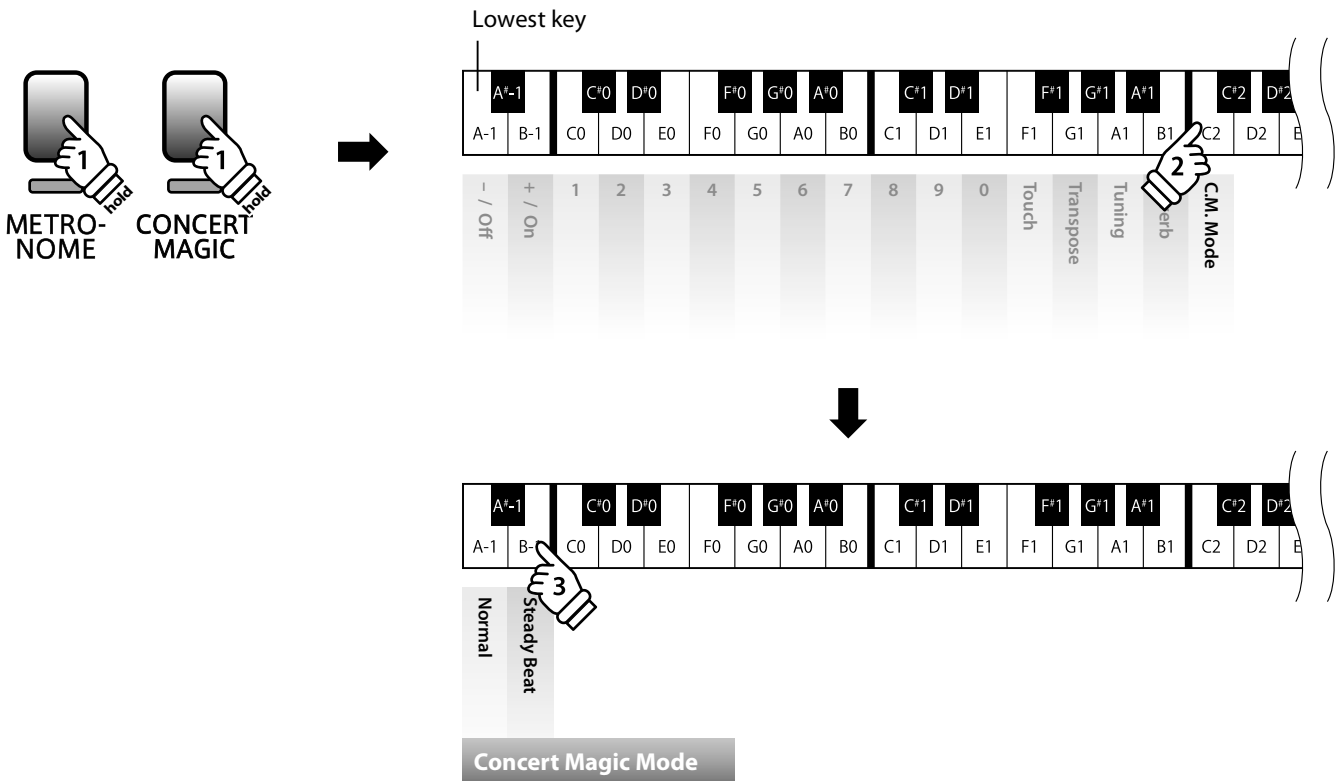

MIDI Settings

The term MIDI is an acronym for Musical Instrument Digital Interface, an international standard for connecting musical instruments, computers, and other devices to allow the exchange of performance data.

■ MIDI terminals

MIDI terminal	Function
MIDI IN	Receiving note, program change, and other data.
MIDI OUT	Sending note, program change, and other data.

■ MIDI channels

MIDI uses channels to exchange data back and forth between MIDI devices. There are receive (MIDI IN) and transmit (MIDI OUT) channels. Most musical instruments or devices with MIDI functions are equipped with both MIDI IN and OUT jacks and are capable of transmitting and receiving data via MIDI. The receive channels are used to receive data from another MIDI device and the transmit channels are used to transmit data to another MIDI device.

The illustration below shows three musical instruments, connected together using MIDI.

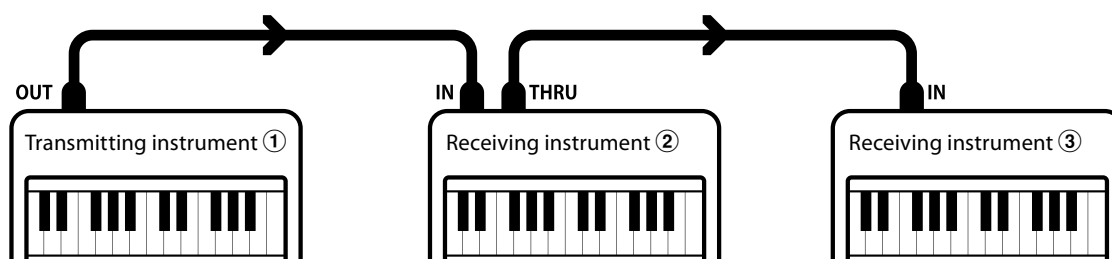

Transmitting instrument ① sends transmit channel and keyboard information to receiving instruments ②/③.

The information arrives at the receiving instruments ②/③.

Receiving instruments ②/③ will respond to MIDI data that is sent if their receive channel is the same as the transmit channel of the transmitting instrument ①.

If the channels do not match, then the receiving instruments ②/③ will not respond to any data that is sent.

For both receiving and transmitting, channels 1-16 can be used.

■ Recording/playing with a sequencer

When connected to a sequencer, the CL26 digital piano can be used to record and playback multi-track songs, with separate sounds playing simultaneously on each channel.

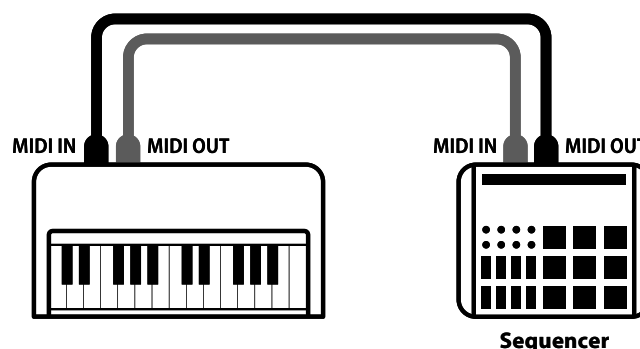

■ MIDI functions

The CL26 digital piano supports the following MIDI functions:

Transmit/receive note information

Transmit/receive note information from a MIDI-connected musical instrument or device.

Transmit/receive channel settings

Specify transmit/receive channels within the range of 1 to 16.

Transmit/receive exclusive data

Transmit/receive front panel or menu function settings as exclusive data.

Multi-timbral mode setting

Receive multiple channel MIDI data from a MIDI-connected musical instrument or device.

* Multi-timbral mode setting must be enabled.

Transmit/receive Program Change number

Transmit/receive program change data to/from a MIDI-connected musical instrument or device.

Transmit/receive pedal data

Transmit/receive sustain, sostenuto, and soft pedal data from a MIDI-connected musical instrument or device.

Receive volume data

Receive MIDI volume data sent from a MIDI-connected musical instrument or device.

* Please refer to the 'MIDI Implementation Chart' on page 38 for further information regarding the MIDI capabilities of the CL26 digital piano.

■ MIDI settings

Function name	Explanation	Default setting
MIDI Channel	Specify the channel used to transmit/receive MIDI information.	01ch
Local Control	Specify whether or not internal sounds will be heard when the keyboard is pressed.	On
Multi-timbral mode	Specify whether or not MIDI information can be received on more than one channel.	Off
Transmit Program Change Number	Specify whether or not program change information is sent when sounds are changed.	Off
Change Number	Send a MIDI program change number from 1 to 128.	

■ Changing MIDI settings

The process for changing MIDI settings is the same as for changing Key and Sound settings (page 20):

Press and hold the METRONOME and CONCERT MAGIC buttons simultaneously, then press the key assigned to the desired setting.

While still holding the METRONOME and CONCERT MAGIC buttons, press the key assigned to the desired MIDI setting's value/type. The changed settings will be applied immediately.

* It is possible to adjust multiple MIDI settings while holding the METRONOME and CONCERT MAGIC buttons.

* Use the included Function Labels (page 10) to reference the CL26's MIDI settings more conveniently.

1 MIDI Channel (transmit/receive)

The MIDI Channel setting allows the transmit/receive channel to be specified. The selected channel will function as both the transmit and receive channel (separate transmit/receive channels cannot be specified).

■ Changing the MIDI Channel setting

Press and hold the METRONOME and CONCERT MAGIC buttons simultaneously, then press the D2 key to select the MIDI Channel setting.

While still holding the METRONOME and CONCERT MAGIC buttons, input the desired MIDI Channel using the number keys indicated below.

The selected MIDI Channel setting will be applied immediately.

- * The MIDI Channel setting can be set within the range of 01 - 16.
- * When the instrument is turned on, the MIDI Channel setting will return to the default value of '01ch'.
- * Use the included Function Labels (page 10) to reference the CL26's MIDI settings more conveniently.

Lowest key

A ⁻¹	C ⁰	D ⁰	F ⁰	G ⁰	A ⁰	C ¹	D ¹	F ¹	G ¹	A ¹	C ²	D ²	F ²	G ²	A ²				
A-1	B-1	C0	D0	E0	F0	G0	A0	B0	C1	D1	E1	F1	G1	A1	B1				
- / Off	+ / On	1	2	3	4	5	6	7	8	9	0	Touch	Transpose	Tuning	Reverb	MIDI Channel	Local Control	Multi-timbral	Transmit PGM#

Example: MIDI Channel 07ch
Press key 0 then key 7.

A ⁻¹	C ⁰	D ⁰	F ⁰	G ⁰	A ⁰	C ¹	D ¹	F ¹	G ¹	A ¹	C ²	D ²	F ²	G ²	A ²
A-1	B-1	C0	D0	E0	F0	G0	A0	B0	C1	D1	E1	F1	G1	A1	B1
		1	2	3	4	5	6	7	8	9	0				

MIDI Channel

2 Local Control

The Local Control setting determines whether the instrument will play an internal sound when the keys are pressed. This setting is useful when using the CL26 digital piano to control an external MIDI device.

Local Control settings

Local Control	Explanation	Key
On (default)	The instrument will play an internal sound and transmit information to an external MIDI device.	B-1
Off	The instrument will transmit information to an external MIDI device only.	A-1

Changing the Local Control setting

Press and hold the METRONOME and CONCERT MAGIC buttons simultaneously, then press the E2 key to select the Local Control setting.

While still holding the METRONOME and CONCERT MAGIC buttons, press the key assigned to the desired Local Control setting. The selected Local Control setting will be applied immediately.

- * When the instrument is turned on, the Local Control setting will return to the default of 'On'.
- * Use the included Function Labels (page 10) to reference the CL26's MIDI settings more conveniently.

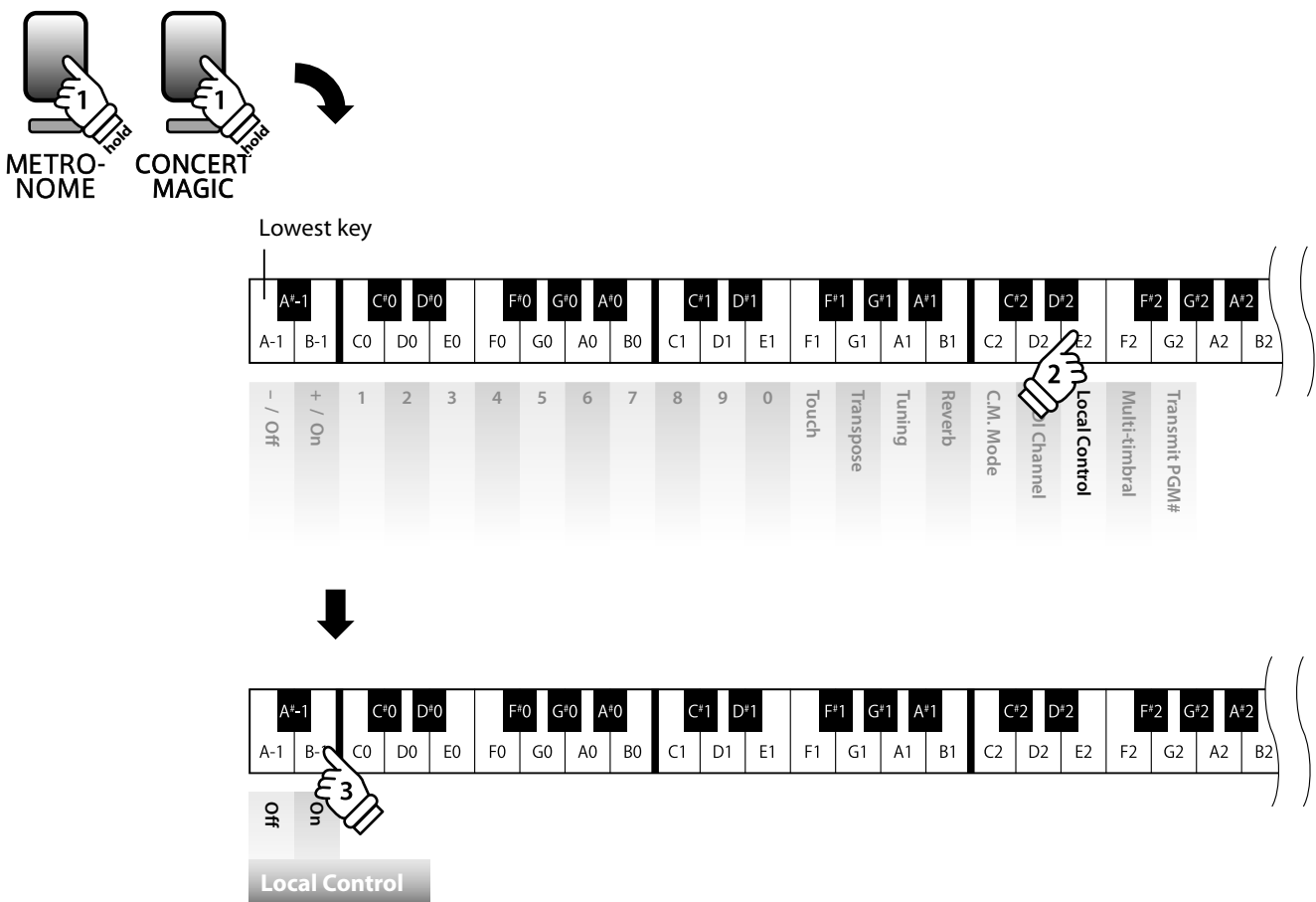

3 Multi-timbral Mode

The Multi-timbral Mode setting determines whether or not the CL26 digital piano is able to receive MIDI information on more than one MIDI channel simultaneously. This allows the instrument to play back multi-track, multi-timbral performance data sent from an external MIDI device.

Multi-timbre Mode settings

Multi-timbre	Explanation	Key
On	Multi-timbral mode enabled*	B-1
Off (default)	Multi-timbral mode disabled	A-1

* Please refer to the 'Program Change Number List' on page 32.

Changing the Multi-timbral Mode setting

Press and hold the METRONOME and CONCERT MAGIC buttons simultaneously, then press the F2 key to select the Multi-timbral Mode setting.

While still holding the METRONOME and CONCERT MAGIC buttons, press the key assigned to the desired Multi-timbral Mode setting. The selected Multi-timbral Mode setting will be applied immediately.

- * When the instrument is turned on, the Multi-timbral Mode setting will return to the default of 'Off'.
- * MIDI data received through channel 10 will not be performed when Multi-timbre is enabled.
- * Use the included Function Labels (page 10) to reference the CL26's MIDI settings more conveniently.

Lowest key

A ⁻¹		C ⁰ D ⁰			F ⁰ G ⁰ A ⁰			C ¹ D ¹			F ¹ G ¹ A ¹			C ² D ²			F ² G ² A ²					
A-1	B-1	C0	D0	E0	F0	G0	A0	B0	C1	D1	E1	F1	G1	A1	B1	C2	D2	E2	F2	G2	A2	B2
- / Off	+ / On	1	2	3	4	5	6	7	8	9	0	Touch	Transpose	Tuning	Reverb	C.M. Mode	MIDI Channel	Local Control	Multi-timbral	Transmit PGM #		

↓

A ⁻¹		C ⁰ D ⁰			F ⁰ G ⁰ A ⁰			C ¹ D ¹			F ¹ G ¹ A ¹			C ² D ²			F ² G ² A ²					
A-1	B-1	C0	D0	E0	F0	G0	A0	B0	C1	D1	E1	F1	G1	A1	B1	C2	D2	E2	F2	G2	A2	B2
Off	On																					

Multi-timbral Mode

4 Transmit MIDI Program Change

The Send Program Change Number setting determines whether or not the CL26 digital piano will transmit program change information when sounds are changes. It is also possible to transmit a program change number (ranging from 1 to 128) in order to change the sound of an external MIDI device.

■ Transmit MIDI Program Change settings

Transmit PGM#	Explanation	Key
On	The instrument will transmit program change numbers when changing sounds.	B-1
Off (default)	The instrument will NOT transmit program change numbers when changing sounds.	A-1

■ Changing the Transmit MIDI Program Change setting

Press and hold the METRONOME and CONCERT MAGIC buttons simultaneously, then press the G2 key to select the Transmit MIDI Program Change setting.

While still holding the METRONOME and CONCERT MAGIC buttons, press the key assigned to the desired Transmit MIDI Program Change setting.

The selected Multi-timbral Mode setting will be applied immediately.

* When the instrument is turned on, the Transmit MIDI Program Change setting will return to the default of 'Off'.

* Use the included Function Labels (page 10) to reference the CL26's MIDI settings more conveniently.

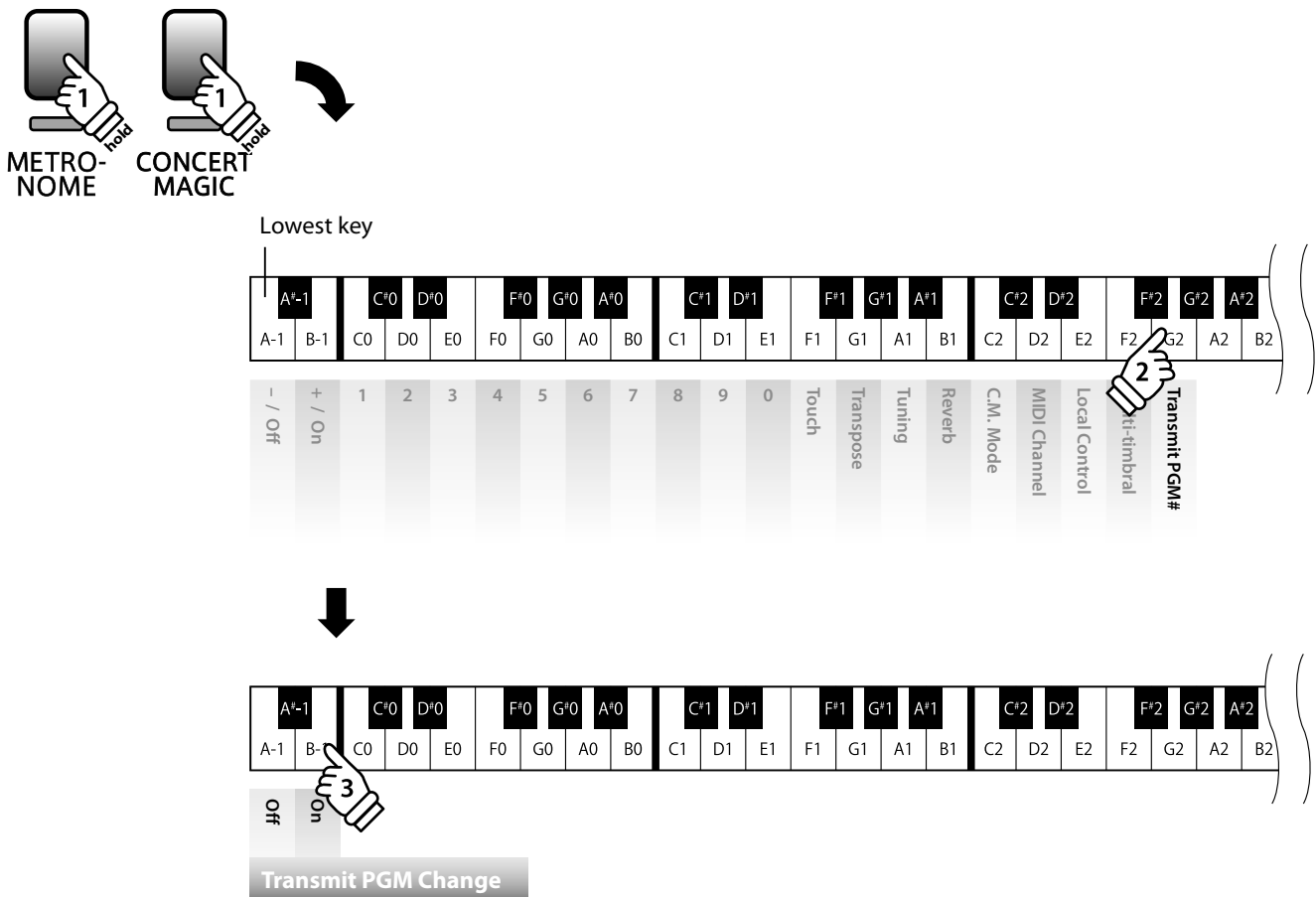

MIDI Settings

Program Change Number List

Sound name	Multi-timbral mode Off		Multi-timbral mode On		
	Program number		Program number	Bank MSB	Bank LSB
Concert Grand	1		1	121	0
Studio Grand	2		1	121	1
Electric Piano	3		5	121	0
Church Organ	4		20	121	0
Harpsichord	5		7	121	0
Vibraphone	6		12	121	0
Strings	7		49	121	0
Choir	8		53	121	0

Sending a MIDI Program Change Number

Press and hold the METRONOME and CONCERT MAGIC buttons simultaneously, then press the G2 key to select the Transmit MIDI Program Change setting.

While still holding the METRONOME and CONCERT MAGIC buttons, input the desired Program Change Number using the number keys indicated below.

The inputted Program Change Number will be sent when the key for the third digit number is pressed.

* Program Change Numbers are specified as three digits within the range of 001 - 128.

* Use the included Function Labels (page 10) to reference the CL26's MIDI settings more conveniently.

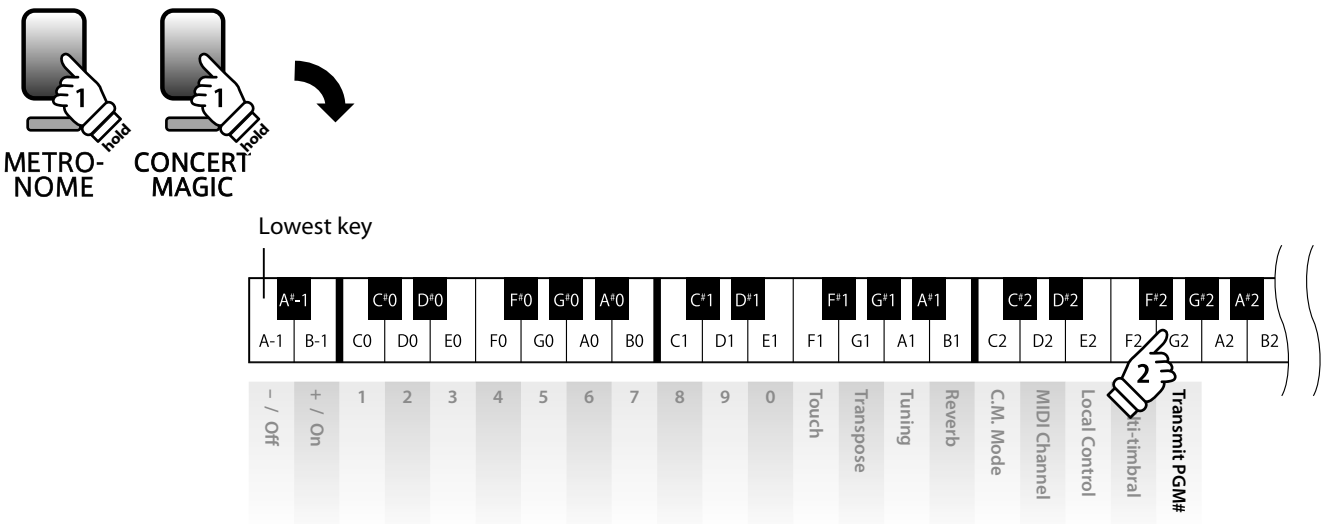

Example: PGM# 120
Press key 1, key 2, then key 0.

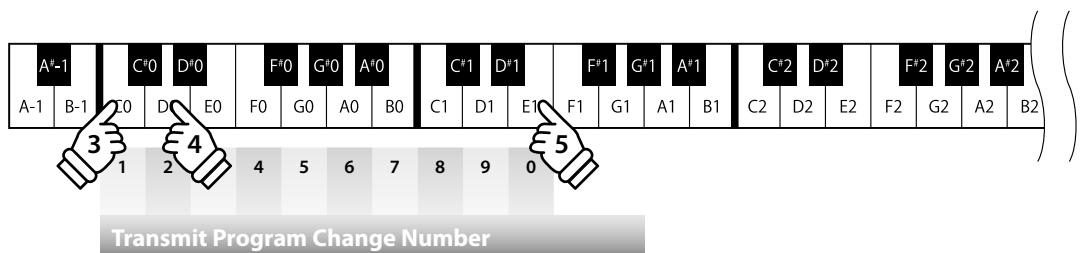

Power Settings

1 Auto Power Off

The CL26 features a power saving function that can be used to automatically turn off the instrument after a specified period of inactivity.

■ Auto Power Off settings

Auto Power Off setting	Explanation	Key
Disabled	The Auto Power Off function is disabled.	C7
120 min.	The instrument will turn off automatically after 120 minutes of inactivity.	B6
60 min.	The instrument will turn off automatically after 60 minutes of inactivity.	A6
30 min.	The instrument will turn off automatically after 30 minutes of inactivity.	G6

■ Changing the Auto Power Off setting

Press and hold the METRONOME and CONCERT MAGIC buttons, then press the key assigned to the desired Auto Power Off setting.

The selected Auto Power Off setting will be applied immediately.

* It is also possible to change the Auto Power Off setting by pressing the key assigned to the desired Auto Power Off setting while pressing and holding the POWER button.

* Use the included Function Labels (page 10) to reference the CL26's Auto Power Off settings more conveniently.

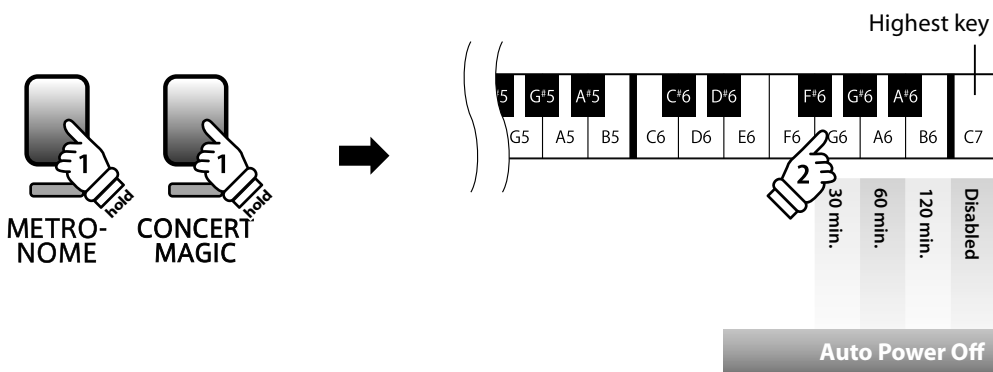

Assembly Instructions



Please read these assembly instructions thoroughly before attempting to assemble the CL26 digital piano.
Please ensure that two or more people work on assembling the CL26 digital piano.

■ Included parts

Before attempting to assemble the CL26 digital piano, please ensure that all parts below are included.

A Phillips-head screwdriver (not included) will also be required in order to assemble the instrument.

To prevent scratches during assembly, it is recommended to cover hard floor surfaces with a towel or blanket.

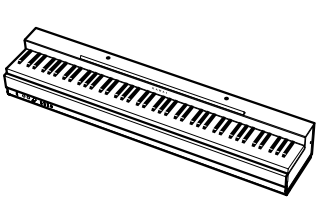

① Main Unit

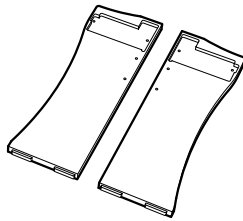

② Side Panels (left, right)

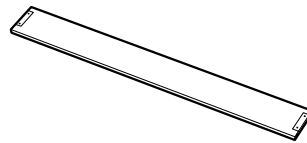

③ Back Board

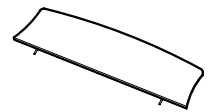

④ Music Rest

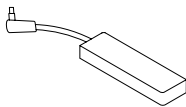

⑤ AC Adaptor



⑥ Power Cable



⑦ Screw (short) x 4



⑧ Screw (long) x 4

1. Attaching the Main Body ①, Side Panels ②, and Back Board ③

Place the Main Unit ① on the floor with its back side facing down, then place the left and right Side Panels ② beside the Main Unit, as shown in the illustration.

Attach the Side Panels ② to the Main Unit ① using four short screws ⑦ in the top two holes on either side.

Attach the Back Board ③ to the Side Panels ② using four long screws ⑧ in the bottom two holes on either side.

Securely tighten all eight screws, ensuring that the Main Unit ①, Side Panels ②, and Bottom Board ③ make close contact, and that there are no large gaps between the assembled parts.



Tighten all screws securely to ensure that the Main Unit and Back Board are firmly attached to the Side Panels.

Failing to do so may result in serious injury.

Remove, reposition, then reattach the glides located on the underside of the left and right Side Panels ② so that they protrude.

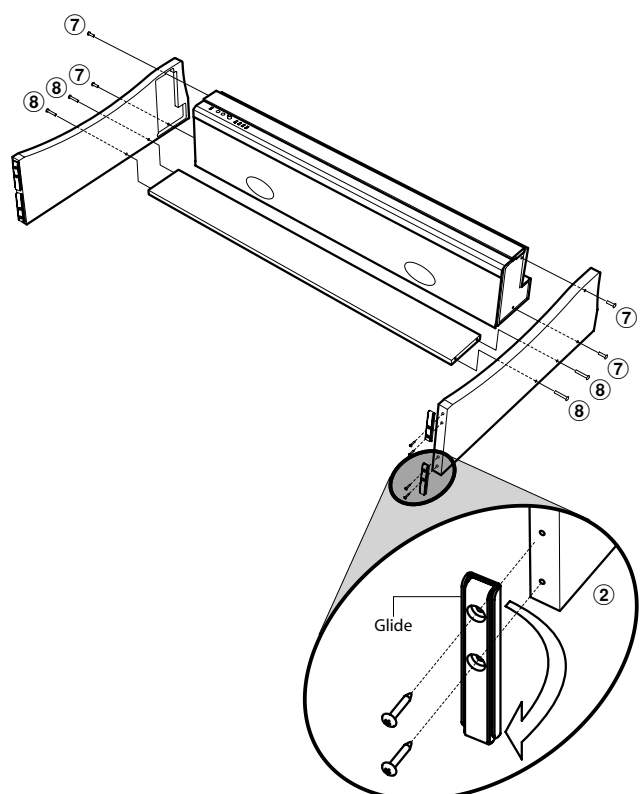

2. Standing the assembly instrument upright

Stand the assembled instrument upright by slowly lifting from the back side of the Main Unit.

Once again, check that all screws are securely fastened, and that the assembled instrument does not wobble from side to side.

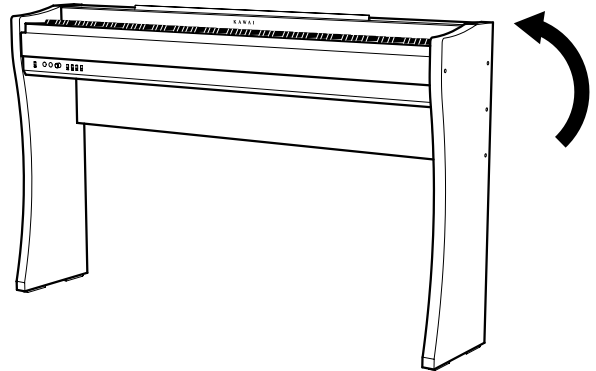

3. Attaching the Music Rest

Attach the Music Rest ④ by carefully inserting the legs into the holes on the top of the Main Unit.

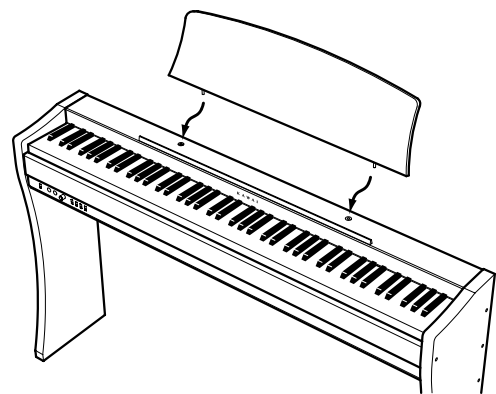

4. Connecting the power adaptor and pedal unit

Connect the Power Cable ⑥ to the AC Adaptor ⑤. Connect the AC Adaptor and F-10H pedal unit to the 'DC IN' and 'PEDAL' jacks located on the underside of the instrument, as indicated below.

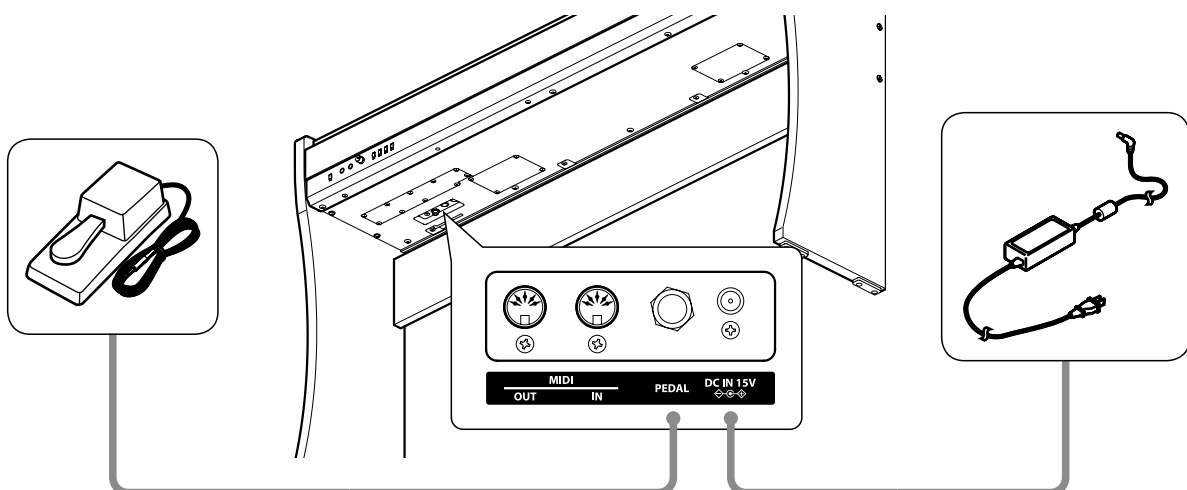

Connecting to Other Devices

■ MIDI IN/OUT jacks

These jacks are located on the underside of the instrument on the left hand side, and used to connect the CL26 digital piano to external MIDI devices, such as a sound module, or a computer with a MIDI interface.

Connect the instrument's MIDI IN jack to the external device's MIDI OUT jack, and the instrument's MIDI OUT jack to the external device's MIDI IN jack.

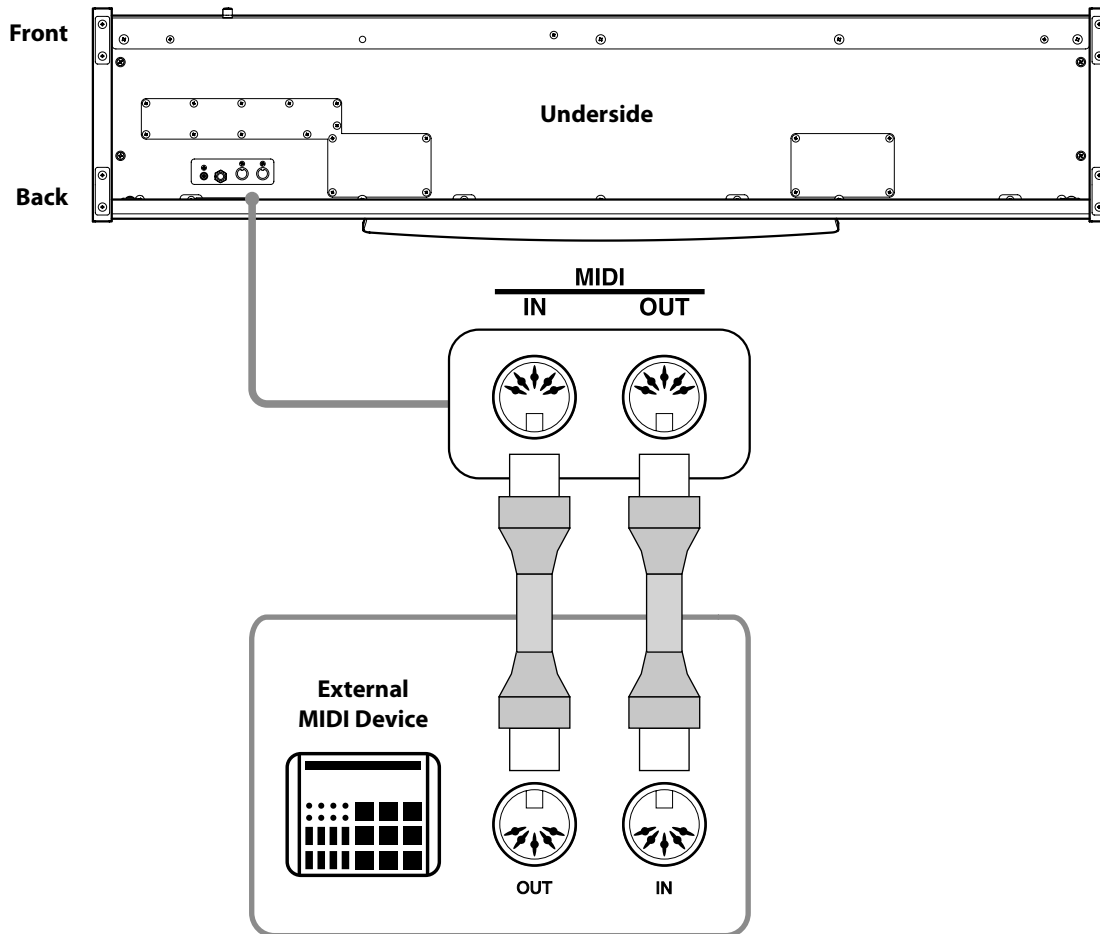

■ Troubleshooting

	Problem	Possible Cause and Solution	Page no.
Power	The instrument does not turn on.	Check that the AC power adaptor is firmly attached to the instrument, and connected to an AC outlet.	p. 11
Sound	The instrument is turned on, however no sound is produced when the keys are played.	Check that the VOLUME knob is not set to the lowest position.	p. 11
		Check that a pair of headphones (or headphone adaptor plug) are not connected to the PHONES jacks.	p. 11
		Check that the 'Local Control' MIDI setting is set to 'On'.	p. 29
	The sound distorts when playing at very loud volume levels.	Check that the VOLUME knob is set to an appropriate level, reducing the volume if excessive distortion is heard.	p. 11
Pedals	The pedal is unreliable or does not function at all.	Check that the pedal cable is firmly connected to the instrument.	p. 11

Specifications

■ Kawai CL26 digital piano

Keyboard	88 weighted keys Advanced Hammer Action IV-F (AHA IV-F)
Sound Source	Harmonic Imaging™ (HI), 88-key piano sampling
Internal Sounds	Concert Grand, Studio Grand, Electric Piano, Church Organ, Harpsichord, Vibraphone, Strings, Choir
Polyphony	max. 96 notes
Reverb	Room, Stage, Hall
Metronome	Beat: 1/4, 2/4, 3/4, 4/4, 5/4, 6/8 Tempo: 10-300 bpm
Demo Songs	8 songs
Concert Magic	40 songs
MIDI Functions	MIDI Channel, Local Control, Multi-timbral mode, Transmit MIDI Program Change
Other Functions	Dual Mode, Touch, Transpose, Tuning, Reverb, Auto Power Off
Pedals	Damper (with half-pedal support) (F-10H unit)
Jacks	Pedal, MIDI (IN/OUT), Headphones x 2
Speakers	(12 x 8 cm) x 2
Output Power	15 W x 2
Power Consumption	30W (AC adaptor PS-154)
Finish	Premium Rosewood Premium Satin Black Premium Satin White
Dimensions (Not including music rack)	1278 (W) x 267 (D) x 770 (H) mm / 50 1/3" (W) x 10 1/2" (D) x 30 1/3" (H) in.
Weight	28.5 kg / 62 lbs., 13 oz.

Specifications are subject to change without notice.

Function...		Transmitted	Recognised	Remarks
Basic Channel	Default Changed	1 1 - 16	1 1 - 16	
Mode	Default Messages Altered	Mode 3 × *****	Mode 1 Mode 1, 3* ×	*The default for the OMNI mode is ON. Specifying MIDI channels automatically turns it OFF.
Note Number	: True voice	15 - 113* *****	0 - 127 15 - 113	* with Transpose
Velocity	Note ON Note OFF	○ 9nH v=1-127 × 9nH v=0	○ ×	
After Touch	Key's Ch's	× ×	× ×	
Pitch Bend		×	×	
Control Change		7 × 64 ○ 67 ×	○ ○ ○	Volume Damper Pedal Soft Pedal
Program Change	True	○ *****	○	See the Program Change Number List on page 32.
System Exclusive		○	○	
Common	: Song Pos. : Song Sel. : Tune	× × ×	× × ×	
System Real time	: Clock : Commands	× ×	× ×	
Aux	: Local ON/OFF : All Notes OFF : Active Sense : Reset	× × ○ ×	○ ○ ○ ×	

Mode 1: OMNI ON, POLY Mode 2: OMNI ON, MONO ○: Yes
Mode 3: OMNI OFF, POLY Mode 4: OMNI OFF, MONO ×: No

KAWAI

THE FUTURE OF THE PIANO

CL26 Owner's Manual

KPSZ-0474 : 817080

OW1054E-J1104

Version 2

Printed in Indonesia

Copyright © 2011 Kawai Musical Instruments Mfg. Co., Ltd. All Rights Reserved.