

KAWAI

DIGITAL PIANO

CN42

Owner's Manual

PART NAMES
AND FUNCTIONS
1

PLAYING THE PIANO
2

LESSON FUNCTION
3

RECORDER
4

USB (TO DEVICE)
OPERATIONS
5

MENU FUNCTIONS
6

APPENDICES
7

Thank you for purchasing a KAWAI CN42 digital piano!

The CN42 digital piano is a revolutionary new instrument that combines the latest digital technology with traditional piano craftsmanship inherited from KAWAI's many years of experience in building fine acoustic pianos. The authentic tone has been created through the stereo sampling of concert grand pianos, and is reproduced using KAWAI's unique Harmonic Imaging™ sound technology, while the Advanced Hammer Action IV-F keyboard action provides the touch response and full dynamic range required for a superb performance of piano, harpsichord, organ, and other instruments.

The CN42 digital piano is also equipped with additional reverb and digital effects processors, delivering a deeper, richer sound, while industry standard MIDI jacks and a USB interface are also provided, allowing the playback of other electronic instruments and connection with personal computers, while the Lesson function helps performers to practice the piano with a collection of etudes from Czerny and Burgmuller, or songs from Alfred's Basic Piano Library and Alfred's Premier Piano Course lesson books (USA, Canada, Australia and UK only).

This owner's manual contains useful information regarding the varied capabilities of the CN42 digital piano. Please read all sections carefully and keep this manual handy for future reference.

Table of Contents

◆ Important Safety Instructions	4	3) TRANSPOSING A SONG.....	36
1. PART NAMES AND FUNCTIONS	8	4) ERASING A SONG	37
◇ FRONT PANEL	8	5. USB (TO DEVICE) OPERATIONS	38
◇ PEDALS	8	1) USB RECORDER.....	38
◇ HEADPHONES.....	9	◇ PLAYING BACK A SONG	38
◇ USB PORT	9	◇ MUTING A PART	39
2. PLAYING THE PIANO	10	◇ RECORDING A SONG	39
1) BASIC OPERATIONS.....	10	◇ ADJUSTING THE VOLUME LEVEL OF THE USB RECORDER... 40	
◇ SETTING UP THE PIANO	10	◇ SAVING THE RECORDED SONG TO THE USB DEVICE... 40	
◇ DEMO SONGS	11	2) USB MENU.....	41
◇ SELECTING A PRESET SOUND	12	◇ 1. INTERNAL SONG SAVE.....	41
2) DUAL.....	13	◇ 2. RENAME.....	41
3) SPLIT.....	14	◇ 3. DELETE	42
4) FOUR HANDS MODE.....	16	◇ 4. SONG COPY	42
◇ ENTERING FOUR HANDS MODE.....	16	◇ 5. MAKE DIR.....	43
◇ EXITING FOUR HANDS MODE	16	◇ 6. FORMAT	43
5) EFFECTS/REVERB	17	6. MENU FUNCTIONS	44
◇ ADDING REVERB	17	1) BRILLIANCE.....	44
◇ ADDING OTHER EFFECTS	18	2) LOWER OCTAVE SHIFT	45
6) SELECTING THE TOUCH SENSITIVITY.....	19	3) LOWER PEDAL ON / OFF	45
7) TRANSPOSING THE PIANO	20	4) LAYER OCTAVE SHIFT.....	46
8) PLAYING WITH CONCERT MAGIC.....	21	5) LAYER DYNAMICS	47
◇ SELECTING A SONG	21	6) DAMPER HOLD ON / OFF.....	48
◇ LISTENING TO THE SONG	21	7) DAMPER EFFECT	49
◇ PERFORMING A SONG	22	8) STRING RESONANCE	50
◇ CONCERT MAGIC PART VOLUME BALANCE.....	23	9) FOUR HANDS ON/OFF	51
◇ CONCERT MAGIC SONG ARRANGEMENT TYPES.....	23	10) TUNING	52
◇ STEADY BEAT	24	11) TEMPERAMENT	53
◇ CONCERT MAGIC DEMO MODES.....	25	12) KEY OF TEMPERAMENT	55
◇ CONCERT MAGIC PLAYBACK SPEED.....	25	◇ MIDI OVERVIEW	56
9) METRONOME / RHYTHM	26	◇ CN42 MIDI FUNCTIONS	56
◇ STARTING THE METRONOME	26	13) MIDI CHANNEL.....	57
◇ CHANGING THE TIME SIGNATURE AND RHYTHM... 26		14) TRANSMIT PROGRAM CHANGE ON / OFF.....	58
◇ ADJUSTING THE METRONOME VOLUME	27	15) LOCAL CONTROL ON / OFF.....	59
◇ RHYTHM LIST	28	16) MULTI-TIMBRAL MODE.....	60
10) PANEL LOCK	29	17) CHANNEL MUTE	61
3. LESSON FUNCTION.....	30	18) SENDING PROGRAM CHANGE NUMBERS	62
1) SELECTING A BOOK/SONG	30	19) MIDI CLOCK.....	63
2) LISTENING TO AND PLAYING A SONG	31	20) USER MEMORY.....	63
◇ EXITING THE LESSON FUNCTION	31	21) FACTORY RESET	64
◇ PRACTICING THE LEFT AND RIGHT-HAND PARTS ... 31		7. APPENDICES.....	65
◇ ADJUSTING THE TEMPO OF A SONG	31	◇ CONNECTING TO OTHER DEVICES.....	65
3) RECORDING A SONG PRACTICE	32	◇ ASSEMBLY INSTRUCTIONS	67
◇ PLAYING BACK THE RECORDING	32	◇ PROGRAM CHANGE NUMBER MAPPING	69
◇ ERASING THE RECORDING.....	32	◇ DRUM SOUND MAPPING.....	76
4. RECORDER	33	◇ SPECIFICATIONS	78
1) RECORDING (REC BUTTON)	33	◇ MIDI EXCLUSIVE DATA FORMAT	79
2) PLAYING BACK A SONG.....	35	◇ MIDI IMPLEMENTATION CHART	80

Important Safety Instructions

SAVE THESE INSTRUCTIONS

INSTRUCTIONS PERTAINING TO A RISK OF FIRE, ELECTRIC SHOCK, OR INJURY TO PERSONS



WARNING

TO REDUCE THE RISK OF FIRE OR ELECTRIC SHOCK, DO NOT EXPOSE THIS PRODUCT TO RAIN OR MOISTURE.

AVIS : RISQUE DE CHOC ELECTRIQUE - NE PAS OUVRIR.

TO REDUCE THE RISK OF ELECTRIC SHOCK, DO NOT REMOVE COVER (OR BACK). NO USER-SERVICEABLE PARTS INSIDE. REFER SERVICING TO QUALIFIED SERVICE PERSONNEL.



The lightning flash with arrowhead symbol, within an equilateral triangle, is intended to alert the user to the presence of uninsulated "dangerous voltage" within the product's enclosure that may be of sufficient magnitude to constitute a risk of electric shock to persons.



The exclamation point within an equilateral triangle is intended to alert the user to the presence of important operating and maintenance (servicing) instructions in the literature accompanying the product.

Examples of Picture Symbols



denotes that care should be taken.
The example instructs the user to take care not to allow fingers to be trapped.



denotes a prohibited operation.
The example instructs that disassembly of the product is prohibited.



denotes an operation that should be carried out.
The example instructs the user to remove the power cord plug from the AC outlet.

Read all the instructions before using the product.

- 1) Read these instructions.
- 2) Keep these instructions.
- 3) Heed all warnings.
- 4) Follow all instructions.
- 5) Do not use this apparatus near water.
- 6) Clean only with dry cloth.
- 7) Do not block any ventilation openings. Install in accordance with the manufacturer's instructions.
- 8) Do not install near any heat sources such as radiators, heat registers, stoves, or other apparatus (including amplifiers) that produce heat.
- 9) Do not defeat the safety purpose of the polarized or grounding-type plug. A polarized plug has two blades with one wider than the other. A grounding type plug has two blades and a third grounding prong. The wide blade or the third prongs are provided for your safety. If the provided plug does not fit into your outlet, consult an electrician for replacement of the obsolete outlet.
- 10) Protect the power cord from being walked on or pinched particularly at plugs, convenience receptacles, and the point where they exit from the apparatus.
- 11) Only use attachments/accessories specified by the manufacturer.
- 12) Use only with the cart, stand, tripod, bracket, or table specified by the manufacturer, or sold with the apparatus. When a cart is used, use caution when moving the cart/apparatus combination to avoid injury from tip-over. 
- 13) Unplug this apparatus during lightning storms or when unused for long periods of time.
- 14) Refer all servicing to qualified service personnel. Servicing is required when the apparatus has been damaged in any way, such as power-supply cord or plug is damaged, liquid has been spilled or object have fallen into the apparatus, the apparatus has been exposed to rain or moisture, does not operate normally, or has been dropped.

WARNING - When using electric products, basic precautions should always be followed, including the following.



WARNING

Indicates a potential hazard that could result in death or serious injury if the product is handled incorrectly.

The product should be connected to an AC outlet of the specified voltage.



- If you are going to use an AC power cord, make sure that it has the correct plug shape and conforms to the specified power voltage.
- Failure to do so may result in fire.

Do not insert or disconnect the power cord plug with wet hands.



Doing so may cause electric shock.

The chair must be used properly (it must be used only when playing the product).

- Do not play with it or stand on it.
- Only one person is allowed to sit on it.
- Do not sit on it when opening the lid.
- Re-tighten the bolts occasionally.

Doing so may cause the chair to fall over or your fingers to be trapped, resulting in injury.

When using the headphones, do not listen for long periods of time at high volume levels.

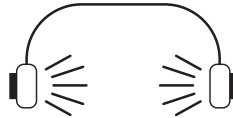

Doing so may result in hearing problems.

Do not lean against the keyboard.

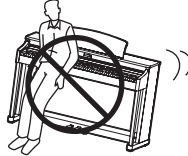

Doing so may cause the product to fall over, resulting in injury.

Do not disassemble, repair or modify the product.

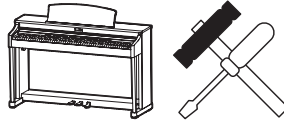

Doing so may result in product breakdown, electric shock or short-circuit.

When disconnecting the AC power cord's plug, always hold the plug and pull it to remove it.



- Pulling the AC power cord itself may damage the cord, causing a fire, electric shock or short-circuit.

The product is not completely disconnected from the power supply even when the power switch is turned off. If the product will not be used for a long time, unplug the AC power cord from the AC outlet.



- Failure to do so may cause fire in case of lightning.
- Failure to do so may over-heat the product, resulting in fire.

This product may be equipped with a polarized line plug (one blade wider than the other). This is a safety feature. If you are unable to insert the plug into the outlet, contact an electrician to replace your obsolete outlet. Do not defeat the safety purpose of the plug.

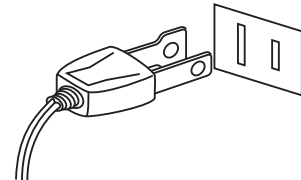

It is a good practice to have the instrument near the AC outlet and the power cord plug in a position so that it can readily be disconnected in an emergency because electricity is always charging while the plug is in the AC outlet even in a power switch off condition.



CAUTION

Indicates a potential hazard that could result in injury or damage to the product or other property if the product is handled incorrectly.

Do not use the product in the following areas.

- Areas, such as those near windows, where the product is exposed to direct sunlight
- Extremely hot areas, such as near a heater
- Extremely cold areas, such as outside
- Extremely humid areas
- Areas where a large amount of sand or dust is present
- Areas where the product is exposed to excessive vibrations

Using the product in such areas may result in product breakdown. Use the product only in moderate climates (not in tropical climates).

When you close the keyboard cover, close it gently.



Closing it roughly may trap your fingers, resulting in injury.

Before connecting cords, make sure that the power to this product and other devices is turned OFF.

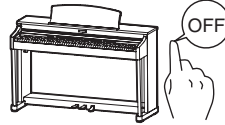

Failure to do so may cause breakdown of this product and other devices.

Take care not to allow any foreign matter to enter the product.

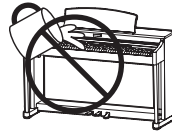

Entry of water, needles or hair pins may result in breakdown or short-circuit. The product shall not be exposed to dripping or splashing. No objects filled with liquids, such as vases, shall be placed on the product.

Do not drag the product on the floor. Take care not to drop the product.

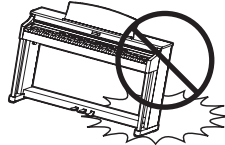

Please lift up the product when moving it. Please note that the product is heavy and must be carried by more than two persons. Dropping the product may result in breakdown.

Do not place the product near electrical appliances such as TVs and radios.

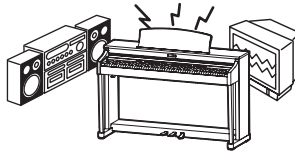

- Doing so may cause the product to generate noise.
- If the product generates noise, move the product sufficiently away from the electrical appliance or connect it to another AC outlet.

When connecting the AC power cord and other cords, take care not to get them tangled.



Failure to do so may damage them, resulting in fire, electric shock or short-circuit.

Do not wipe the product with benzene or thinner.



- Doing so may result in discoloration or deformation of the product.
- When cleaning the product, put a soft cloth in lukewarm water, squeeze it well, then wipe the product.

Do not stand on the product or exert excessive force.



- Doing so may cause the product to become deformed or fall over, resulting in breakdown or injury.

Do not place naked flame, such as lighted candles on the product.

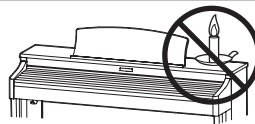

Doing so may cause the illumination to fall over, resulting in fire.

Ensure that the ventilation is not impeded by covering the ventilation openings with items, such as newspaper, table-cloths, curtains, etc.

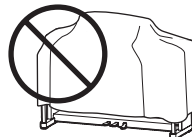

Failure to do so may over-heat the product, resulting in fire.

The product should be located so that its location or position does not interfere with its proper ventilation. Ensure a minimum distance of 5cm around the product for sufficient ventilation.

The product should be serviced by qualified service personnel when:

- The power supply cord or the plug has been damaged.
- Objects have fallen, or liquid has been spilled into the product.
- The product has been exposed to rain.
- The product does not appear to operate normally or exhibits a marked change in performance.
- The product has been dropped, or the enclosure damaged.

Notes on Repair

Should an abnormality occur in the product, immediately turn the power OFF, disconnect the power cord plug, and then contact the shop from which the product was purchased.

CAUTION:

To prevent electric shock, match wide blade of plug to wide slot, fully insert.

ATTENTION:

Pour éviter les chocs électriques, introduire la lame la plus large de la fiche dans la borne correspondante de la prise et pousser jusqu'au fond.

Instruction for AC power cord (U.K.)

Do not plug either terminal of the power cord to the ground of the AC outlet on the wall.

Canadian Radio Interference Regulations

This instrument complies with the limits for a class B digital apparatus, pursuant to the Radio Interference Regulations, C.R.C., c. 1374.

**An information on Disposal for users**

If your product is marked with this recycling symbol it means that, at the end of its life, you must dispose of it separately by taking it to an appropriate collection point.

You should not mix it with general household waste. Disposing of this product correctly will prevent potential negative effects on the environment and human health which could otherwise arise due to inappropriate waste handling.

For further details, please contact your local authority.
(European Union only)

FCC Information

This equipment has been tested and found to comply with the limits for a Class B digital device, pursuant to Part 15 of the FCC Rules. These limits are designed to provide reasonable protection against harmful interference in a residential installation. This equipment generates, uses and can radiate radio frequency energy and, if not installed and used in accordance with the instructions, may cause harmful interference to radio communications. If this equipment does cause harmful interference to radio or television reception, which can be determined by turning the equipment off and on, the user is encouraged to try to correct the interference by one or more of the following measures:

- Reorient or relocate the receiving antenna.
- Increase the separation between the equipment and receiver.
- Connect the equipment into an outlet on a different electrical circuit from the receiver.
- Consult the dealer or an experienced radio/TV technician for help.

FCC WARNING

Changes or modifications not expressly approved by the party responsible for compliance could void the user's authority to operate the equipment.

**Declaration of Conformity**

This device complies with Part 15 of the FCC Rules. Operation is subject to the following two conditions: (1) this device may not cause harmful interference, and (2) this device must accept any interference received, including interference that may cause undesired operation.

Model Name :	CN42
Responsible Party Name :	Kawai America Corporation
Address :	2055 East University Drive Rancho Dominguez, CA 90220
Telephone :	310-631-1771

This applies only to products distributed by Kawai America Corporation.

1. PART NAMES AND FUNCTIONS

This section explains the locations and functions of the panel buttons and sliders.

◇ FRONT PANEL

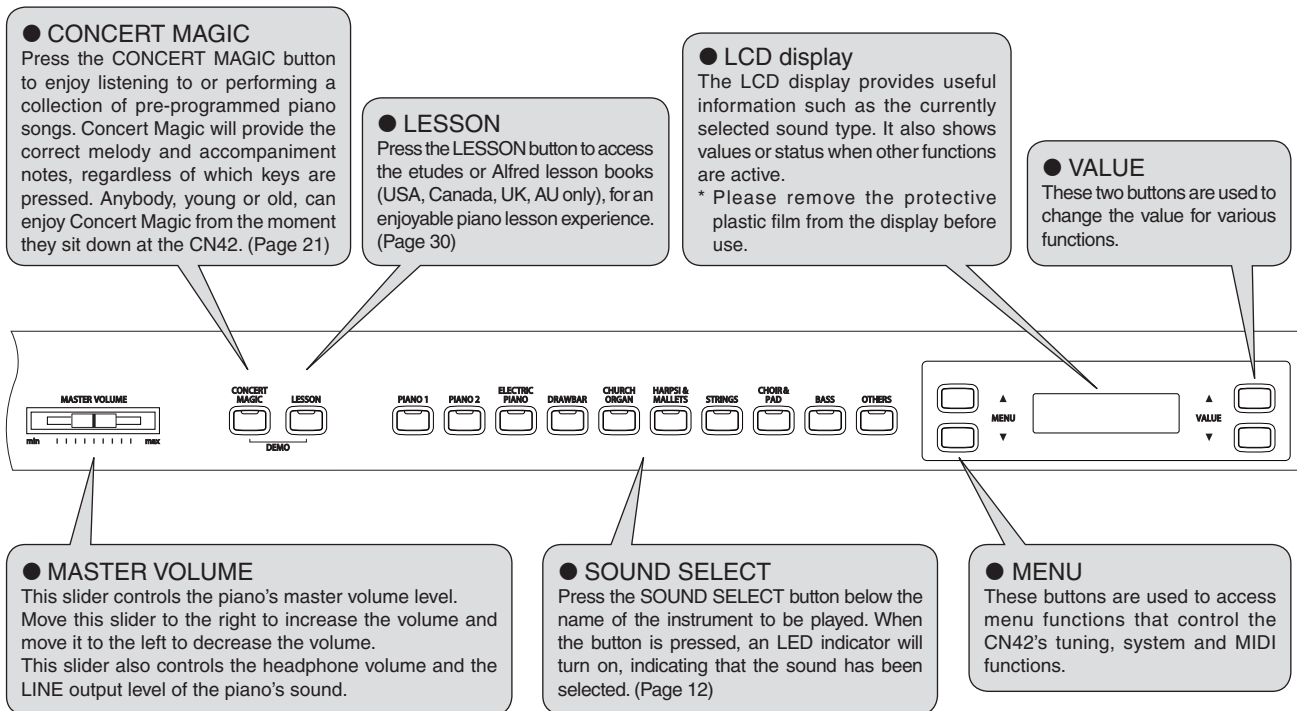

◇ PEDALS

The CN42 piano has three pedals—just like a grand piano. They are Sustain, Sostenuto and Soft.

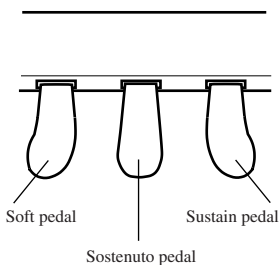

◆ Sustain pedal

Sustains the sound after hands are lifted from the keyboard. The sustain pedal is capable of responding to half pedaling.

◆ Sostenuto pedal

Depressing this pedal after playing the keyboard and before releasing the keys sustains the sound of only the keys just played. Any keys that are pressed after the Sostenuto pedal is depressed will not be sustained after the keys are released.

◆ Soft pedal

Depressing this pedal softens the sound and reduces its volume. When the rotary effect is active the soft pedal is used to change the speed of the rotor between slow and fast.

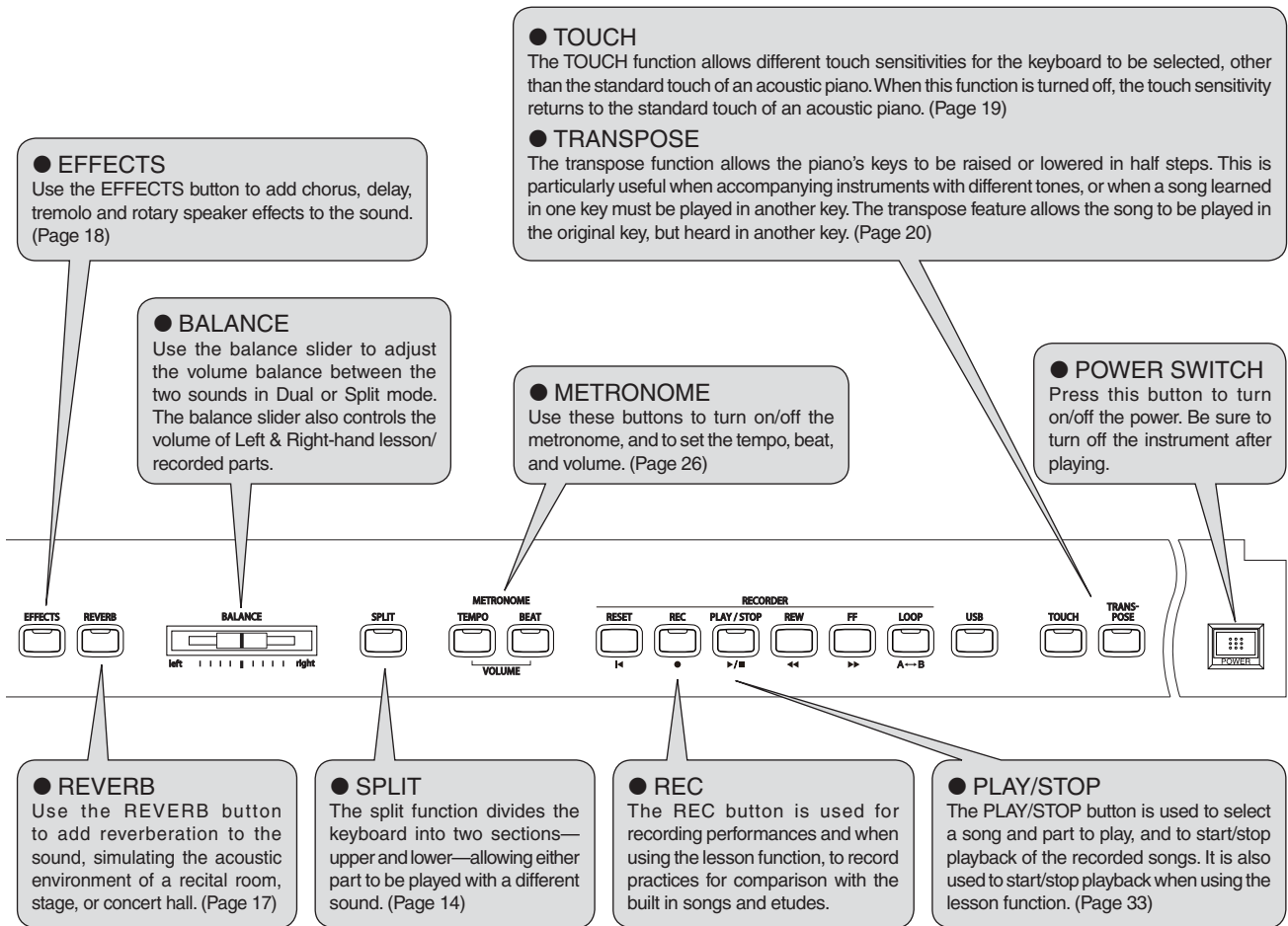

◆ HEADPHONES

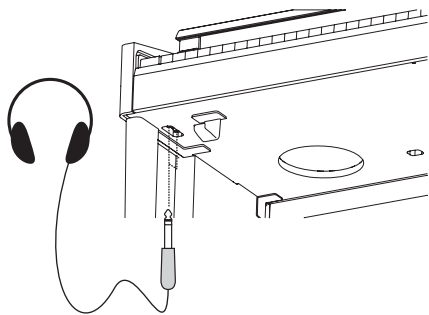

◆ Headphone jack (x 2)

There are two headphone jacks located on the left underside of the piano.

Up to two pairs of headphones can be connected simultaneously.

- See page 68 for information on attaching the headphone hooks.

◆ USB PORT

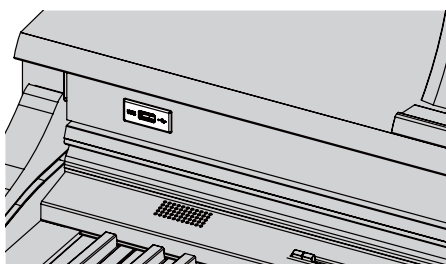

This USB (to Device) port allows USB memory or USB floppy disk drive devices to be connected to the CN42 piano. This provides a convenient way to playback Standard MIDI File (SMF) songs, or access the USB Recorder allowing up to 16 independent tracks to be recorded separately.

2. PLAYING THE PIANO

1) BASIC OPERATIONS

This section provides the basic procedures for turning the power on and playing the CN42 piano.

◇ SETTING UP THE PIANO

The CN42 piano is equipped with stereo speakers and an amplifier—no additional equipment is required to begin playing the instrument, provided AC power is available.

□ Step 1

Connect one end of the AC power cable to the piano's power jack and the other end of the cable to a wall AC outlet.

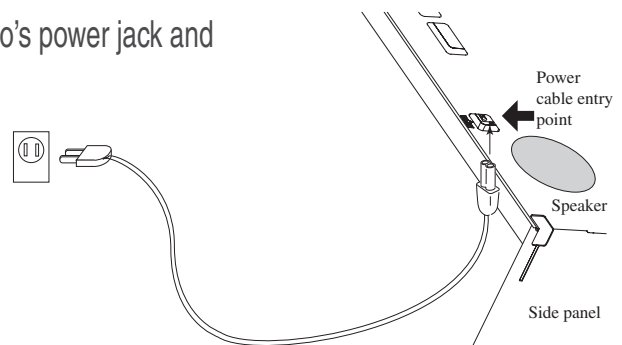

□ Step 2

Press the POWER SWITCH to turn on the power.

The POWER SWITCH is located at the right end of the front panel.

Press the POWER SWITCH again to turn off the power. When the POWER button is pressed, the LED indicator for the PIANO1 button will turn on and the Concert Grand sound will automatically be selected.

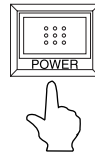

'Concert Grand' will also be shown in the LCD display.

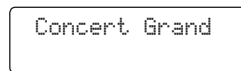

□ Step 3

Adjust the volume level using the MASTER VOLUME slider.

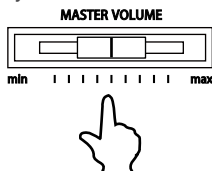

The MASTER VOLUME slider controls the volume level of the speakers and connected headphones.

Move this slider to the right to increase the volume and move it to the left to decrease the volume.

Use this slider to set the volume to a comfortable listening level—the middle is often a good starting point.

◇ DEMO SONGS

The CN42 includes 32 built-in sound demo songs. Each of the demo songs presents a musical piece to introduce the different preset sounds.

■ PIANO 1 Concert Grand : KAWAI Studio Grand : KAWAI Mellow Grand : Sonata No.30 Op.109 / Beethoven Modern Piano : KAWAI		■ HARPSI & MALLETS Harpsichord : French Suite No.6 / Bach Vibraphone : KAWAI Clavi : KAWAI	
■ PIANO 2 Concert Grand 2 : Waltz No.6 Op.64-1 "Petit Chien" / Chopin Studio Grand 2 : KAWAI Mellow Grand 2 : La Fille aux Cheveux de lin / Debussy Rock Piano : KAWAI		■ STRINGS Slow Strings : KAWAI String Pad : KAWAI String Ensemble : Le quattro stagioni La primavera / Vivaldi	
■ ELECTRIC PIANO Classic E.Piano : KAWAI Modern E.P. : KAWAI Modern E.P. 2 : KAWAI		■ CHOIR & PAD Choir : KAWAI Choir 2 : KAWAI New Age Pad : KAWAI Atmospher : KAWAI	
■ DRAWBAR Jazz Organ : KAWAI Drawbar Organ : KAWAI Drawbar Organ 2 : KAWAI		■ BASS Wood Bass : KAWAI Fretless Bass : KAWAI W. Bass & Ride : KAWAI	
■ CHURCH ORGAN Church Organ : Toccata / Gigout Diapason : Wohl mir, daß ich Jesum habe / Bach Full Ensemble : KAWAI		■ OTHERS Rhapsody Op.79 No.2 / Brahms Piano Concerto a minor Op.16 / Grieg	

KAWAI regret that sheet music for KAWAI original demo songs is not available.

□ Step 1

Press the **CONCERT MAGIC** and **LESSON** buttons simultaneously.

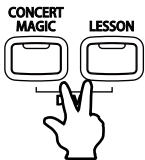

The LED indicators for the **CONCERT MAGIC** button and the **LESSON** button will turn on and the **SOUND SELECT** buttons will start to flash.

The demo song for the **PIANO 1** category will start. After the **PIANO 1** demo songs have finished playing, the demo songs for another sound category will be selected at random.

- There are 4 songs stored for the **PIANO1** sound, which will be played in order. Pressing the **PIANO1** button repeatedly will select the next piano song.

□ Step 2

Press the other **SOUND SELECT** buttons while the demo is playing to listen to demos from each category.

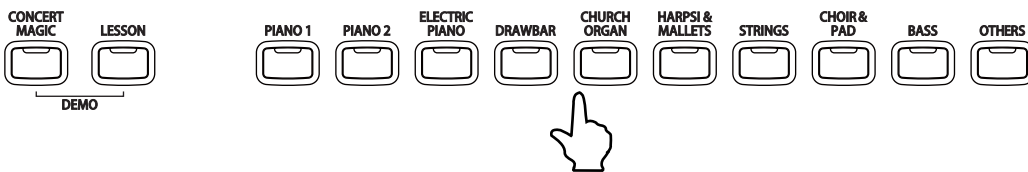

- When this button is pressed, demo songs for the newly selected category will be played. Demo songs from another category will then be selected at random.

□ Step 3

Press the **CONCERT MAGIC** and **LESSON** buttons simultaneously again, or press the **PLAY/STOP** button to exit the demo mode.

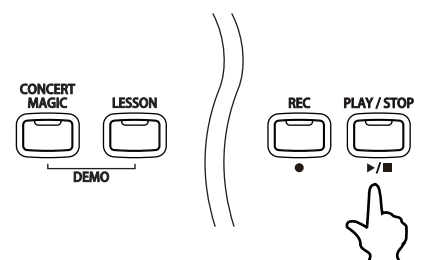

◇ SELECTING A PRESET SOUND

□ Step 1

Press the SOUND SELECT button below the name of the instrument to be played.

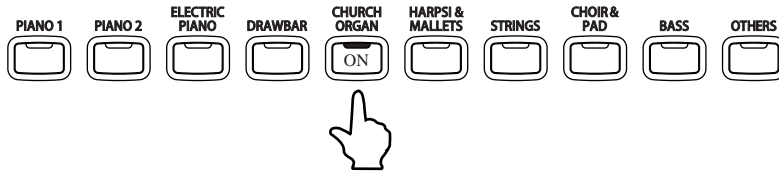

When the button is pressed, the LED indicator will turn on, indicating that this sound has been selected.

The name of the selected preset sound is also shown in the LCD display. Multiple sounds are assigned to each button; pressing the same SOUND SELECT button again will select the next variation sound assigned to that SOUND SELECT button.

To select a Church Organ sound, press the CHURCH ORGAN button as shown above. The LED indicator for the CHURCH ORGAN button will turn on.

- Preset sounds can also be selected by pressing the VALUE buttons.
- The OTHERS button is assigned with 283 sounds, divided into 20 additional categories. While holding down one of the VALUE buttons, pressing the other VALUE button will jump to the next sound category within the OTHERS selection.



■ PRESET SOUNDS

■PIANO 1	Concert Grand	■HARPSI & MALLETS	Harpichord
	Studio Grand		Harpichord 2
	Mellow Grand		Vibraphone
	Modern Piano		Clavi
■PIANO 2	Concert Grand 2	■STRINGS	Slow Strings
	Studio Grand 2		String Pad
	Mellow Grand 2		Warm Strings
	Rock Piano		String Ensemble
■ELECTRIC PIANO	Classic E.P.	■CHOIR & PAD	Choir
	Modern E.P.		Choir 2
	60's E.P.		New Age
	Modern E.P. 2		Atmosphere
■DRAWBAR	Jazz Organ	■BASS	Wood Bass
	Drawbar Organ		Electric Bass
	Drawbar Organ 2		Fretless Bass
	Be 3		W. Bass & Ride
■CHURCH ORGAN	Church Organ	■OTHERS	283 sounds
	Diapason		
	Full Ensemble		
	Diapason Oct.		

Please refer to 'PROGRAM CHANGE NUMBER MAPPING' on page 69 for a complete listing of the additional 283 sounds assigned to the OTHERS button.

□ Step 2

Play the keyboard.

The selected sound will be heard as the keys are pressed.

Use the MASTER VOLUME slider to adjust the volume if necessary.

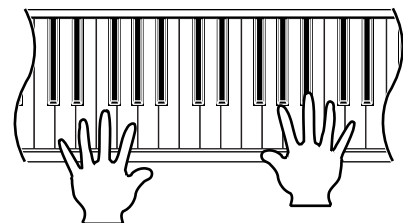

- The CN42 piano is capable of playing up to 192 notes simultaneously (192-note polyphony). However, when playing in dual mode, or when playing a stereo piano sound, the polyphony will be reduced by half because the piano has to produce two sounds for each note.

2) DUAL

The DUAL function allows two preset sounds to be layered together, creating a more complex sound. For example, a piano can be layered with strings, or a church organ with a choir sound.

□ Step 1

Press and hold down a SOUND SELECT button to select the first desired sound. Then press another SOUND SELECT button to select the second desired sound.

The LED indicators for each button will turn on, indicating that the two sounds have been selected, and the names of both instruments will be shown in the LCD display.

For example, to layer a piano sound and a string sound, press the PIANO 1 and STRINGS buttons simultaneously as shown in the diagram.

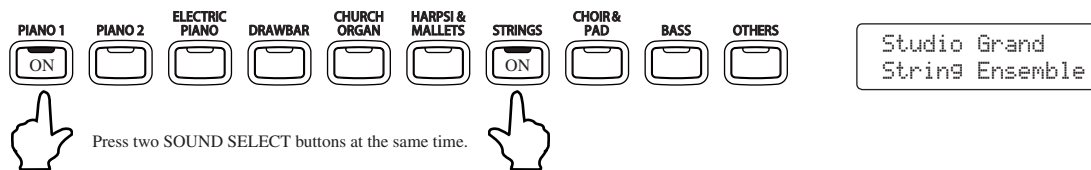

Pressing either of the SOUND SELECT buttons again will select the other sound variations assigned to that button.

For example, to change the String Ensemble sound to Slow Strings, press and hold the PIANO 1 button and press the STRINGS button again.

If two sound variations assigned to the same SOUND SELECT button are to be layered, while pressing the desired SOUND SELECT button, use the VALUE buttons to select the desired sound variation. For example, to layer Concert Grand and Mellow Grand together, first press the PIANO 1 button to select Concert Grand, and then use the VALUE buttons to select Mellow Grand while still holding down the PIANO 1 button.

□ Step 2

Play the keyboard.

Two different sounds will be heard at the same time.

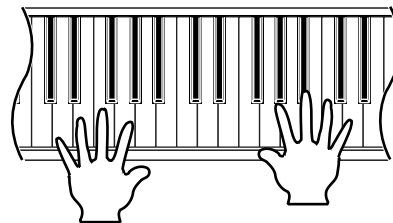

□ Step 3

Use the BALANCE slider to adjust the volume balance between the two sounds.

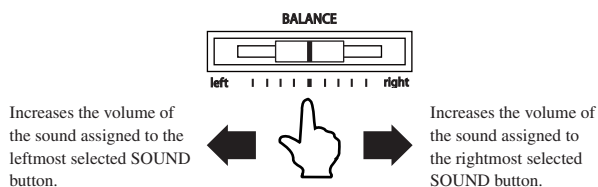

□ Step 4

Press any individual SOUND SELECT button to cancel DUAL mode.

3) SPLIT

The SPLIT function divides the keyboard into two sections—upper and lower—allowing each part to be played with a different sound.

□ Step 1

Press the SPLIT button.

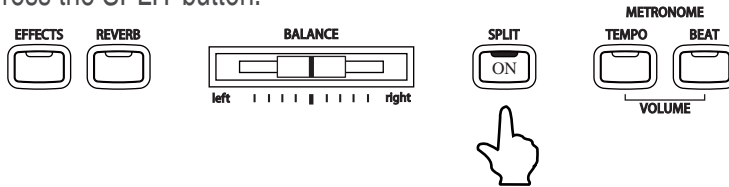

The LED indicator for the SPLIT button will turn on.

The LED indicator for the upper SOUND SELECT button will also be turned on, while the LED indicator for the lower SOUND SELECT button will start to flash.

The names of the selected upper and lower sounds will also be shown in the LCD display.

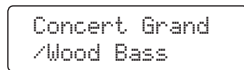

The 'S' symbol will be displayed in the bottom left corner of the LCD display, indicating that split mode has been activated.

The default split point is set between B2 and C3. This point can be moved to any key on the keyboard.

□ Step 2

Press and hold the SPLIT button, then press a key on the keyboard.

The pressed key will become the lowermost note for the upper section.

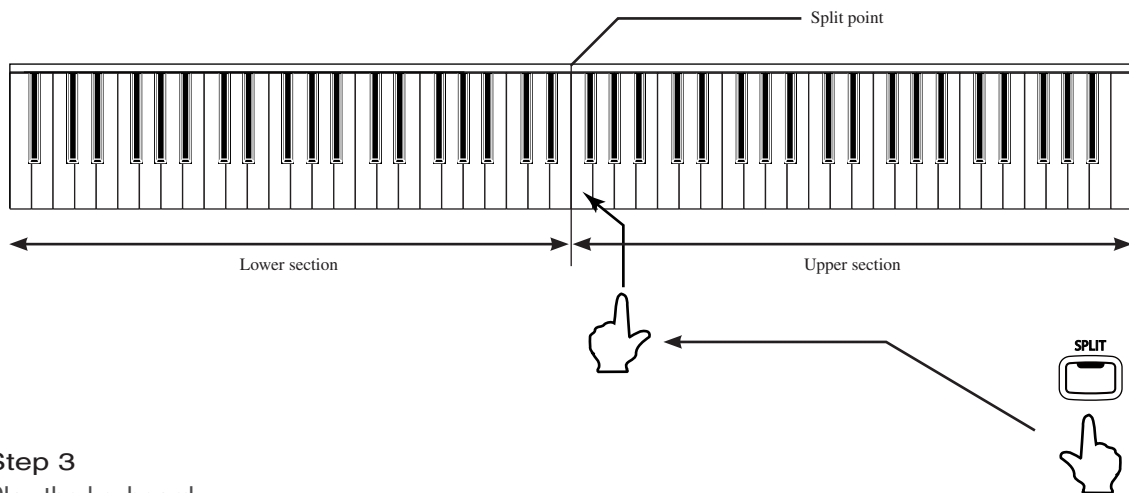

□ Step 3

Play the keyboard.

Different sounds will be produced in the upper and lower sections.

An ensemble performance can be enjoyed by playing the chords and the melody with the right hand, while playing a bass line with the left hand.

□ Step 4

To change the upper sound while SPLIT mode is enabled, press the desired SOUND SELECT button.

The LED indicator for the selected SOUND SELECT button will turn on.

Press the same button repeatedly to select another sound variation assigned to that button.

□ Step 5

To change the lower sound while SPLIT mode is enabled, press and hold the SPLIT button, then press the desired SOUND SELECT button.

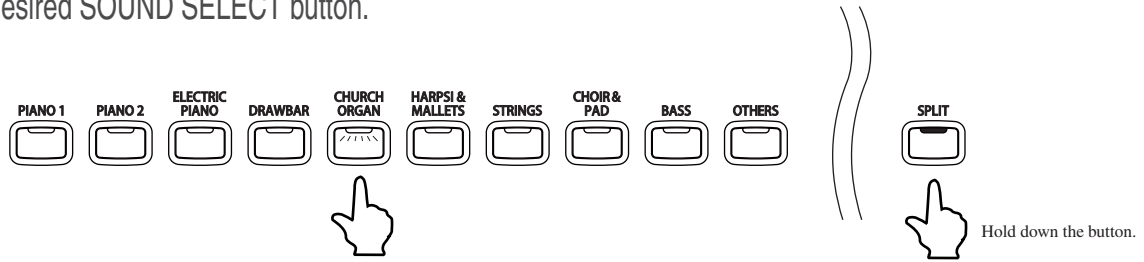

The LED indicator for the selected SOUND SELECT button will start to flash.

Press the same button repeatedly to select another sound variation assigned to that button.

□ Step 6

Use the BALANCE slider to adjust the volume balance between the upper and lower sections.

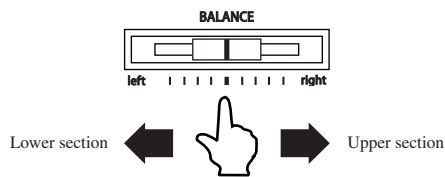

□ Step 7

Press the SPLIT button to exit the split mode.



The LED indicator for the SPLIT button will turn off.

- When SPLIT mode is enabled, 'Lower Octave Shift' can be used to adjust the octave range for the lower section. (Page 45)
- The Sustain pedal can also be turned ON / OFF for the lower section. (Page 45)

4) FOUR HANDS MODE

In FOUR HANDS mode the CN42 piano keyboard is split into upper and lower sections, allowing two players to play the piano together. The sounds in the upper section are transposed two octaves down from the original pitch, while sounds from the lower section are transposed two octaves up from the original pitch, with both players playing in the same key range. The left pedal can also be used as a damper pedal for the player sitting on the left.

◇ ENTERING FOUR HANDS MODE

□ Step 1

Press and hold the SPLIT button, then press the sustain (right) pedal and the soft (left) pedal together.

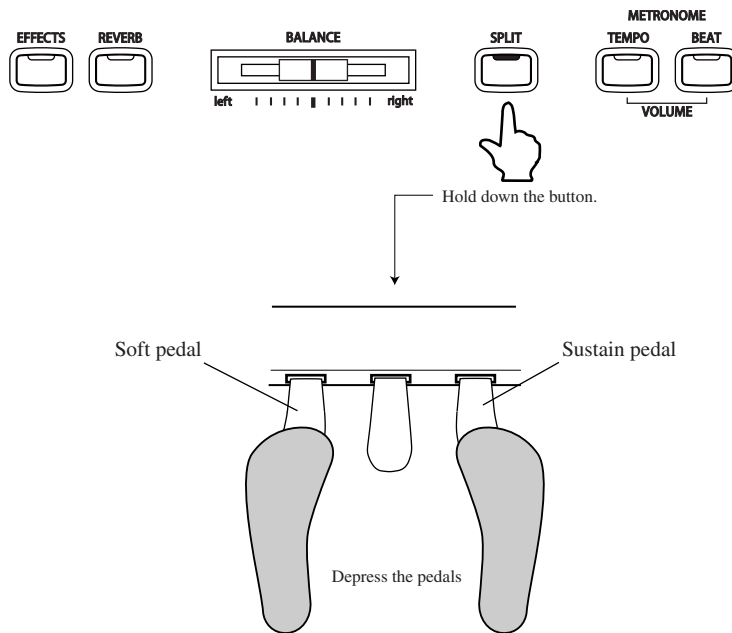

The LED indicator for the SPLIT button will start to flash, indicating that the piano is in FOUR HANDS mode.

◆ Selecting Sounds in FOUR HANDS Mode

When in FOUR HANDS mode, the method for selecting sounds is the same as in SPLIT mode. Press the desired SOUND SELECT button to change the sound for the upper section, or press and hold the SPLIT button, then press the desired SOUND SELECT button to change the sound for the lower section.

◆ Changing Split Point

When in FOUR HANDS mode, the method for changing the SPLIT point is the same as in SPLIT mode. Press and hold the SPLIT button, then press a key on the keyboard. The pressed key becomes the lowermost note for the upper section. The default SPLIT point is set between E3 and F3.

Finally, when in FOUR HANDS Mode, the OCTAVE SHIFT function can also be used to change the octave of the lower section. (Page 45)

- It is also possible to activate FOUR HANDS mode by using the FOUR HANDS ON/OFF function in the Function menu. Please refer to the instructions on page 51 for more information.

◇ EXITING FOUR HANDS MODE

□ Step 1

To exit FOUR HANDS Mode, press the SPLIT button again.

The LED indicator for the SPLIT button will turn off.

5) EFFECTS/REVERB

When selecting some preset sounds, the LED indicator for the EFFECTS or REVERB buttons may turn on automatically. This is because certain preset sounds are prepared with an effect enabled as their default setting. Adding an effect to the sound enhances tonal quality and improves acoustic realism. This CN42 piano features two separate groups of effects. The first is reverb and the second contains chorus, flanger, delay, tremolo and rotary speaker effects.

◇ ADDING REVERB

◆ REVERB

Reverb adds reverberation to the sound, simulating the acoustic environment of a recital room, stage, or concert hall. There are six types of reverb available: Room 1, Room 2, Stage, Hall 1, Hall 2 and Plate.

□ Step 1

Press the REVERB button.

The LED indicator will turn on to indicate that reverb is in use. Press and hold the REVERB button to show the currently selected reverb type in the display.

□ Step 2

To change the reverb type, use the VALUE buttons while holding down the REVERB button.

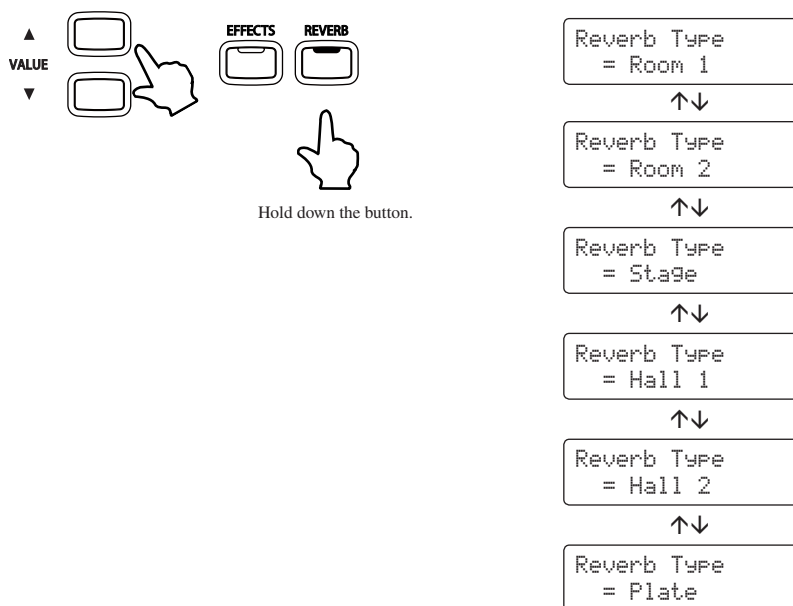

To turn off the reverb, press the REVERB button again.

Press the REVERB button once again to turn the reverb back on. The previously selected reverb type will be used.

Any changes made to the reverb type or on / off status will remain until the power is turned off.

When the power is turned off the reverb settings will return to the default settings.

◇ ADDING OTHER EFFECTS

◆ CHORUS

Chorus is an effect that simulates the rich character of a vocal choir or string ensemble, enriching the original voice by over-layering a slightly detuned version of the sound.

◆ FLANGER

Flanger creates a shifting comb-filter, which adds motion and a 'hollow' tone to the sound.

◆ DELAY

Delay is an effect that adds echoes to the sound. There are three types of delay available (delay 1, delay 2 and delay 3), each with a different length of delay between the echoes.

◆ TREMOLO

This is a vibrato type effect.

◆ ROTARY

This effect simulates the sound of the Rotary Speaker cabinet commonly used with electronic organs. Rotary 1 is normal rotary and Rotary 2 is with distortion effect. The soft pedal is used to change the speed of the rotor between SLOW and FAST.

□ Step 1

Press the EFFECTS button.

The LED indicator will turn on to indicate that the effect is in use. Press and hold the EFFECTS button to show the currently selected effect in the display.

□ Step 2

To change the effect type, press and hold the EFFECTS button and press the VALUE buttons.

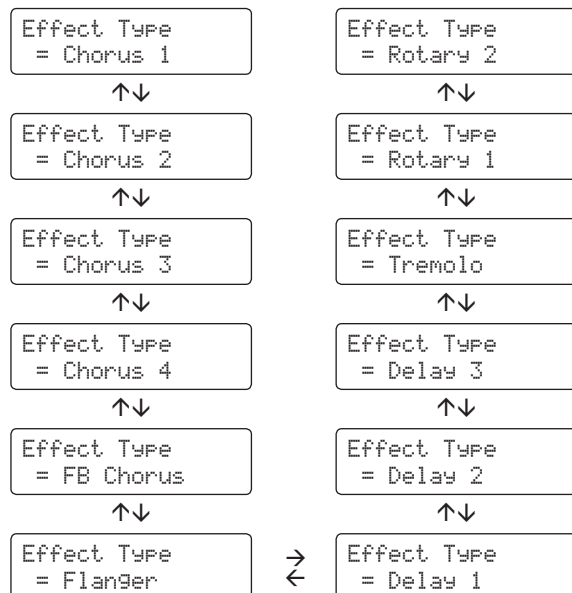
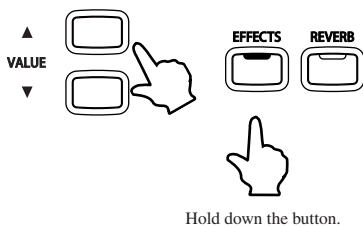

To turn off the effects, press the EFFECTS button again.

Press the EFFECTS button once again to turn the effects back on. The previously selected effect type will be used.

Any changes made to the effect type or on / off status will remain until the power is turned off.

When the power is turned off the effect settings will return to the default settings.

6) SELECTING THE TOUCH SENSITIVITY

The TOUCH function allows different touch sensitivities for the keyboard to be selected, other than the standard touch of an acoustic piano. The sensitivity can be changed to one of five different settings: Light, Light +, Heavy, Heavy + or Off.

①Light +	: For players with a delicate touch. Requires less striking force to achieve a forte note.
②Light	: For those still developing finger strength. A louder volume is produced even when playing with a soft touch.
③Normal	: Reproduces the standard touch sensitivity of an acoustic piano. This touch setting is selected when the LED indicator for the TOUCH button is off.
④Heavy	: Perfect for those with strong fingers. Requires a heavier touch to produce a loud volume.
⑤Heavy +	: Requires more striking force to achieve a loud volume.
⑥Off	: A constant volume is produced regardless of how hard the keys are struck. This setting is suitable for sounds that have a fixed dynamic range such as Organ and Harpsichord.

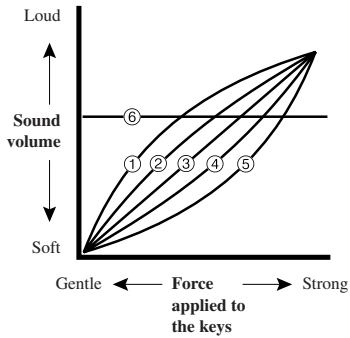

□ Step 1

Press the TOUCH button to change from the standard (Normal) touch setting.

The LED indicator for the TOUCH button will turn on, indicating that the piano is using a different touch setting.

□ Step 2

To change the touch type, press and hold the TOUCH button and press the VALUE buttons.

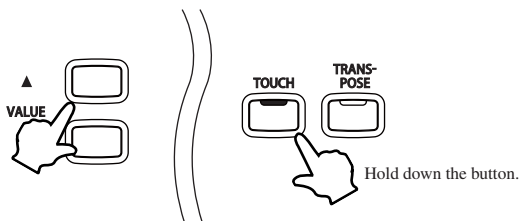

Press and hold the TOUCH button to show the currently selected touch curve in the display.

Touch
= Light

Press the TOUCH button again to return to the standard (Normal) touch setting.

The touch setting is global for all of the preset sounds. It is not possible to have individual touch settings for each preset sound.

When the power is turned off the touch settings will return to the default settings.

- LIGHT and HEAVY do not represent the physical weight of the keys. These are settings that affect the sensitivity of the keys, which determines the volume level in response to the key movement.

7) TRANSPOSING THE PIANO

The transpose function allows the piano's keys to be raised or lowered in half steps. This is particularly useful when accompanying instruments with different tones, or when a song learned in one key must be played in another key. The transpose feature allows the song to be played in the original key, but heard in another key.

□ Step 1

Press and hold the TRANSPOSE button. While holding the TRANSPOSE button, use the VALUE buttons or the keyboard keys from C3 to C5 to specify the transposition amount.

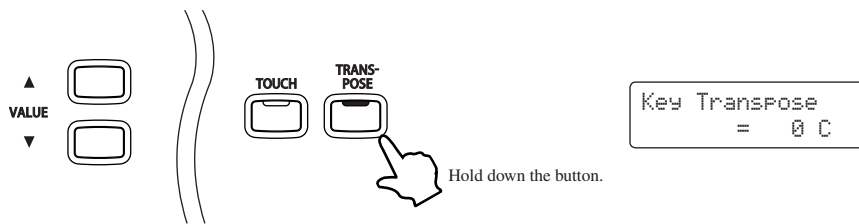

The display will show a number indicating how many half steps up or down the piano has been transposed.

'-5', for example, represents a transposition that is 5 half steps lower.

'0' indicates no transposition.

Each time the VALUE ▲ button is pressed, the transpose value is increased by one half step, while each time the VALUE ▼ button is pressed, the transpose value is decreased by one half step.

The piano can be transposed by up to 12 half steps higher or 12 half steps lower.

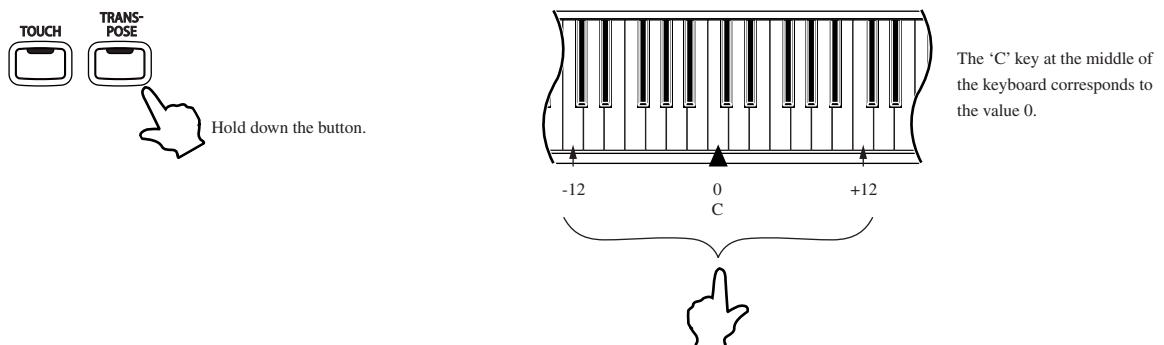

Pressing the TRANSPOSE button again turns the TRANSPOSE function off.

The TRANSPOSE function remembers the current setting as long as the power is on.

- Transpose is active when the LED indicator is on, and the notes are transposed according to the set transpose value. For example if the setting is '-3' and the LED indicator for the TRANSPOSE button is on, the notes will be transposed 3 half steps lower. When the LED indicator for the TRANSPOSE button is turned OFF, the transpose setting will automatically return to '0' (no transposition) with one touch.
- When the value is set to '0', the LED indicator will not turn on.
- The CN42 piano's transpose setting defaults to '0' each time the power is turned on.
- Please refer to page 36 for information regarding the SONG TRANSPOSE function.

8) PLAYING WITH CONCERT MAGIC

The great German composer Johann Sebastian Bach once said “*Playing the keyboard is simple. Just strike the right keys at the right time*”. Many pianists wish it were quite that straightforward. Fortunately, KAWAI have devised a method of playing the keyboard that is very simple, without even needing to strike the right keys.

With CONCERT MAGIC, absolutely anyone can sit at the CN42 piano and make real music - even complete beginners who have never taken a piano lesson in their life. To enjoy performing with Concert Magic, simply select a favorite piece from the 88 pre-programmed songs and tap any key with a steady rhythm and tempo. Concert Magic will provide the correct melody and accompaniment notes, regardless of which keys are pressed. With Concert Magic anybody, young or old, can enjoy playing music from the moment they sit down at the CN42 piano.

◇ SELECTING A SONG

The 88 Concert Magic songs are assigned to each of the 88 keys, and classified by song category into eight groups, such as *Children’s Songs*, *American Classics*, *Christmas Songs* etc. Please refer to the separate ‘Concert Magic Song List/Lesson Song List’ booklet for a complete listing of available Concert Magic songs.

□ Step 1

To select a song, press and hold the CONCERT MAGIC button and press the key to which the desired song is assigned.

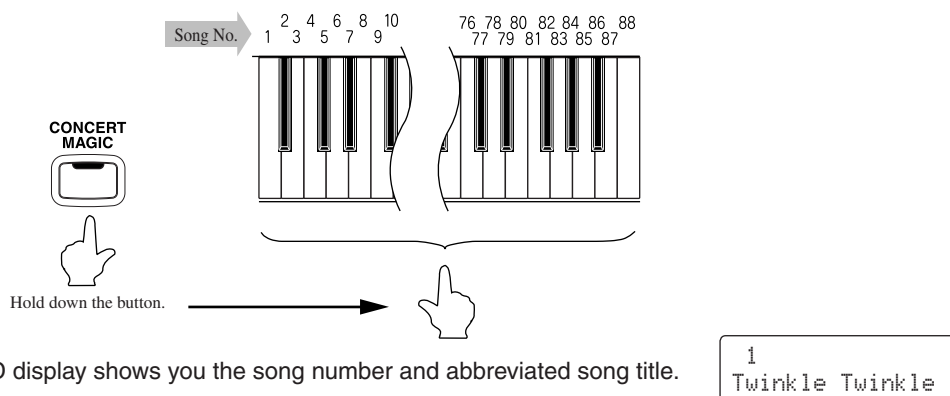

The LCD display shows you the song number and abbreviated song title.

◇ LISTENING TO THE SONG

If the performer is already familiar with the selected Concert Magic song, he/she may wish to begin playing straight away. However, those unfamiliar with the piece may alternatively wish to listen to the song first, before attempting to play it.

□ Step 1

To listen, press the PLAY/STOP button.

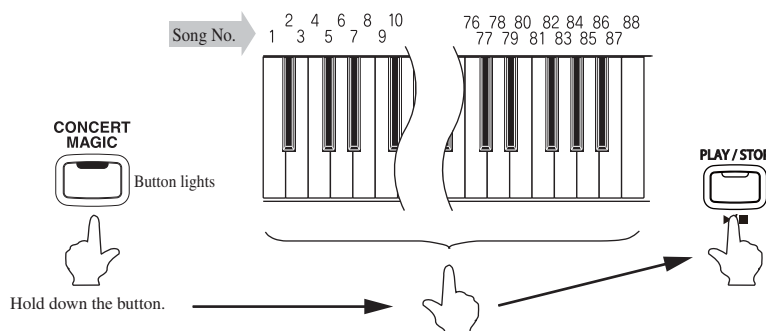

The CN42 piano will start playing back the selected song.

The speed or tempo of the song can be adjusted by pressing and holding the TEMPO button and pressing the VALUE buttons.

While listening, different Concert Magic songs can be selected by pressing the VALUE buttons.

The small circles in the LCD display will be replaced by plus ('+') signs as the song is played back. These small symbols provide a visual playing guide, indicating when the next key should be pressed. The position and spacing between each circle shown in the LCD display represents an approximate timing between each key press.

The circles will be replaced by small plus signs as the song is played.

Twinkle Twinkle
+ + ● ●

The key to performing using Concert Magic is to become familiar with the rhythm of each song. The approximate outline provided by the Note Navigator, allows the performer to gradually learn the rhythm of each piece.

- To listen to a different song, press and hold the CONCERT MAGIC button and press the key to which the desired song is assigned. Then press the PLAY/STOP button.

□ Step 2

Press the PLAY/STOP button again to finish listening to the song.

◇ PERFORMING A SONG

□ Step 1

Tap out the rhythm of the selected song on any one of the piano's 88 black or white keys.

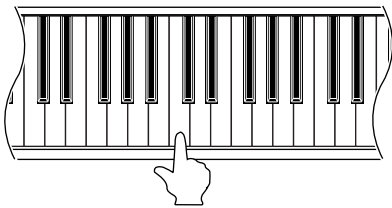

Use the Note Navigator (the circles and plus signs) to learn the rhythm of the Concert Magic song.

● ● ●
+ + ● ●

Concert Magic songs will respond to changes in playing style. As the keys are tapped harder, the music will grow louder; if the keys are tapped more softly, the music will become quieter. Tapping faster will cause the music to speed up, while tapping slower will make the music slow down accordingly. Using Concert Magic, even inexperienced pianists can sound like they have been playing for years, simply by pressing one key with one finger.

Concert Magic is a perfect method for small children to learn music, especially when developing a sense of rhythm. For older people who may believe it is too late to learn the piano, Concert Magic offers an enjoyable first step. With Concert Magic, the CN42 piano can be enjoyed by everyone in the family, even those who have never touched a musical instrument in their life.

◇ CONCERT MAGIC PART VOLUME BALANCE

When used with Concert Magic, the BALANCE slider adjusts the volume balance of the melody part and the accompaniment.

□ Step 1

Move the balance slider to the right or left to adjust the volume balance.

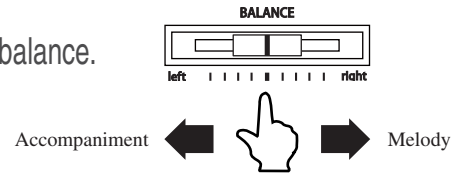

As the slider is moved to the right, the sound of the melody becomes louder and the accompaniment becomes softer. The balance changes in the opposite way when the slider is moved to the left.

◇ CONCERT MAGIC SONG ARRANGEMENT TYPES

After playing with Concert Magic for a while, performers may feel that such playing is too easy and that there is very little to learn. While it is true that some of the songs are very easy to play, even for beginners, there are also some songs which will prove challenging, and require practice to play proficiently.

Each of the 88 Concert Magic songs fall into one of three different arrangement types, depending on the skill level required to perform them.

■ EASY BEAT

These are the easiest songs to play. To perform them, simply tap out a constant steady beat on any key on the keyboard. Look at the following example, 'Für Elise'. The Note Navigator will indicate that a constant, steady rhythm should be maintained throughout the song. This is the distinguishing character of an Easy Beat song.

Press the key with a steady sixteenth note rhythm.

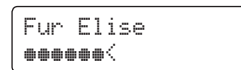

Key on X

■ MELODY PLAY

These songs are also quite easy to play, especially if they are familiar to the player. To perform them, tap out the rhythm of the melody on any key on the keyboard. Singing along as the rhythm is tapped can be helpful. Play 'Twinkle, Twinkle, Little Star' for example. Follow the melody's rhythm as shown.

Key on X X X X X X X X X X X X X

When performing fast songs with Concert Magic, it is sometimes easier to tap two different keys with two alternating fingers in order to play at greater speed.

■ SKILLFUL

These songs range in difficulty from moderately difficult to difficult. To perform them, tap out the rhythm of both the melody and the accompaniment notes on any key on the keyboard, such as 'Waltz of the Flowers' shown below. The Note Navigator will be very helpful with the Skillful songs.

Waltz of Flowers
 ■ ■ ■ ■ <

Key on X X X X X X X X X X X X X

It may take a little practice to perform the Concert Magic songs proficiently. A good way to learn is to listen to these pieces first, and then try to tap out the rhythms that are heard.

- The separate 'Concert Song List/Lesson Song List' booklet lists the arrangement type next to each song title as 'EB' for Easy Beat, 'MP' for Melody Play and 'SK' for Skillful.

◇ STEADY BEAT

Steady Beat allows Concert Magic songs to be played by simply tapping any key with a constant steady beat, regardless of the song arrangement type.

□ Step 1

Press and hold the CONCERT MAGIC button.

The current Concert Magic mode will be shown on the second line of the LCD display.

The default Concert Magic mode is NORMAL.

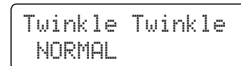

□ Step 2

While still holding the CONCERT MAGIC button, use the VALUE button to change the Concert Magic mode to STEADY BEAT.

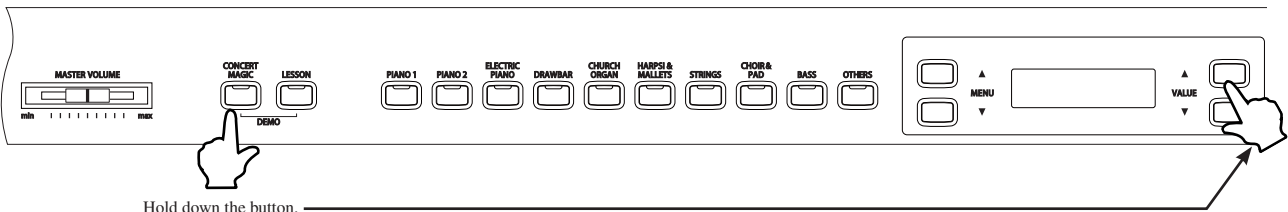

The Concert Magic mode will change to STEADY BEAT.

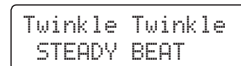

□ Step 3

Start by tapping any key with a constant steady beat.

The tapping speed will set the tempo for the song. Both the accompaniment and melody parts will be played automatically in time with the tapped tempo.

◇ CONCERT MAGIC DEMO MODES

There are three ways to listen to the Concert Magic songs in the DEMO mode.

◆ ALL PLAY

Press the CONCERT MAGIC button and then press the PLAY/STOP button without selecting a song. The CN42 piano will play back all of the Concert Magic songs in order.

◆ RANDOM PLAY

Press the CONCERT MAGIC button and then press the LESSON button. The CN42 piano will play back all of the Concert Magic songs in random order.

◆ CATEGORY PLAY

Press and hold the CONCERT MAGIC and LESSON buttons and press the piano key to which the desired song is assigned. The CN42 piano will play back the selected song and then continue to play the rest of the songs in the same category.

To stop the demo, press the PLAY/STOP button.

◇ CONCERT MAGIC PLAYBACK SPEED

The TEMPO button is also used to adjust the playback speed of Concert Magic songs.

□ Step 1

After selecting a Concert Magic song to play back, press and hold the TEMPO button.

The tempo value will be shown in the LCD display.

□ Step 2

While holding down the TEMPO button, use the VALUE buttons to change the tempo.

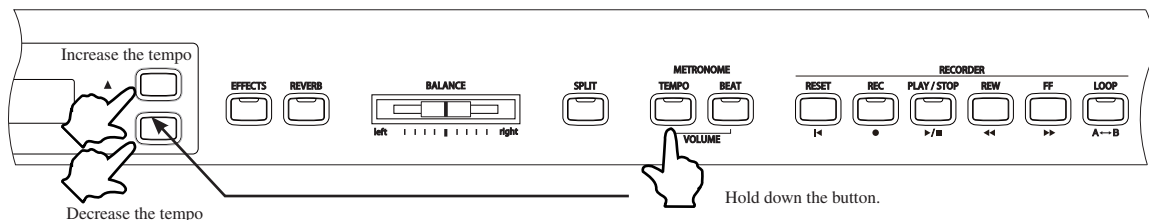

The tempo of the selected Concert Magic song can be adjusted either before playback, or while the song is playing.

9) METRONOME / RHYTHM

Rhythm is one of the most important elements when learning music. It is important to practice playing the piano at the correct tempo and with a steady rhythm. The CN42 piano's metronome tool helps learners to achieve this by providing a steady beat to play along with.

◇ STARTING THE METRONOME

□ Step 1

Press the TEMPO button.

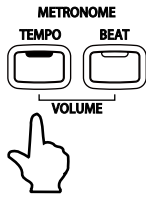

The LED indicator for the TEMPO button will turn on and the metronome will begin counting with a steady beat. The tempo in beats per minute will be shown in the LCD display.

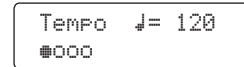

□ Step 2

Press the VALUE buttons to increase or decrease the tempo within the range of 10 - 400 beats per minute. (20-800 BPM with eighth note rhythms).



□ Step 3

Press the TEMPO button again to stop the metronome.

◇ CHANGING THE TIME SIGNATURE AND RHYTHM

The metronome produces two types of click, with the louder click heard on every fourth beat - this is a 4-beat or 4/4 time signature.

The metronome is capable of providing a down beat to indicate the beginning of the measure.

It is possible to select a different signature where appropriate. There are ten different times signatures available on the CN42 piano: 1/4, 2/4, 3/4, 4/4, 5/4, 3/8, 6/8, 7/8, 9/8 and 12/8. Alternatively, one of the 100 built-in rhythm styles can be used instead of a simple metronome click.

□ Step 1

Press the BEAT button.

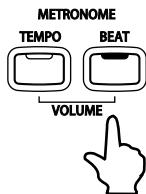

The LED indicator for the BEAT button will turn on and the metronome will begin counting. The currently selected time signature and a visual indicator of each beat will be shown in the LCD display.

If a rhythm is selected, the currently selected rhythm name will be shown in the LCD display.

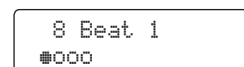
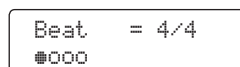

□ Step 2

Press the VALUE buttons to select the desired time signature / rhythm.



The currently selected time signature or rhythm will be shown in the LCD display.

□ Step 3

Press the BEAT button again to stop the metronome.

Both the TEMPO button and the BEAT button can be used to turn the metronome on and off, depending on whether the tempo or time signature is being adjusted.

◇ ADJUSTING THE METRONOME VOLUME

The volume level of the metronome can also be adjusted.

□ Step 1

Press the TEMPO and BEAT buttons simultaneously.

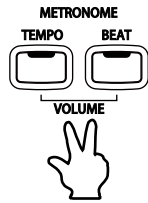

The volume level of the metronome will be shown in the LCD display, represented by numbers ranging from 1 (soft) to 10 (loud). The default metronome volume level is 5.

```
Volume = 5
#000
```

□ Step 2

Press the VALUE buttons to increase or decrease the volume level of the metronome.



□ Step 3

Press the TEMPO and BEAT buttons simultaneously again to stop the metronome.

◇ RHYTHM LIST

No.	Rhythm	No.	Rhythm
1	8 Beat 1	51	Hip Hop 3
2	8 Beat 2	52	Hip Hop 4
3	8 Beat 3	53	Techno 1
4	16 Beat 1	54	Techno 2
5	16 Beat 2	55	Techno 3
6	16 Beat 3	56	Heavy Techno
7	16 Beat 4	57	8 Shuffle 1
8	16 Beat 5	58	8 Shuffle 2
9	16 Beat 6	59	8 Shuffle 3
10	Rock Beat 1	60	Boogie
11	Rock Beat 2	61	16 Shuffle 1
12	Rock Beat 3	62	16 Shuffle 2
13	Hard Rock	63	16 Shuffle 3
14	Heavy Beat	64	T Shuffle
15	Surf Rock	65	Triplet 1
16	2nd Line	66	Triplet 2
17	50 Ways	67	Triplet 3
18	Ballad 1	68	Triplet 4
19	Ballad 2	69	Triplet Ballad 1
20	Ballad 3	70	Triplet Ballad 2
21	Ballad 4	71	Triplet Ballad 3
22	Ballad 5	72	Motown 1
23	Light Ride 1	73	Motown 2
24	Light Ride 2	74	Ride Swing
25	Smooth Beat	75	H.H. Swing
26	Rim Beat	76	Jazz Waltz 1
27	Slow Jam	77	Jazz Waltz 2
28	Pop 1	78	5/4 Swing
29	Pop 2	79	Tom Swing
30	Electro Pop 1	80	Fast 4 Beat
31	Electro Pop 2	81	H.H. Bossa Nova
32	Ride Beat 1	82	Ride Bossa Nova
33	Ride Beat 2	83	Beguine
34	Ride Beat 3	84	Mambo
35	Ride Beat 4	85	Cha Cha
36	Slip Beat	86	Samba
37	Jazz Rock	87	Light Samba
38	Funky Beat 1	88	Surdo Samba
39	Funky Beat 2	89	Latin Groove
40	Funky Beat 3	90	Afro Cuban
41	Funk 1	91	Songo
42	Funk 2	92	Bembe
43	Funk 3	93	African Bembe
44	Funk Shuffle 1	94	Merenge
45	Funk Shuffle 2	95	Reggae
46	Buzz Beat	96	Tango
47	Disco 1	97	Habanera
48	Disco 2	98	Waltz
49	Hip Hop 1	99	Ragtime
50	Hip Hop 2	100	Country & Western

10) PANEL LOCK

The Panel Lock function allows the state of all panel buttons to be temporarily locked, preventing sounds and other settings from being changed accidentally while playing the piano.

□ Step 1

Press the CONCERT MAGIC and TRANSPOSE buttons simultaneously.

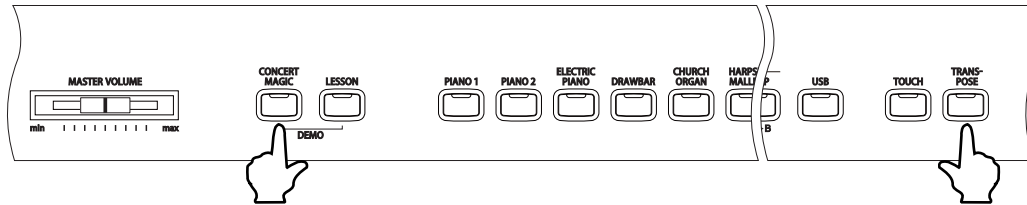

The CN42 control panel will stop responding to button pushes.

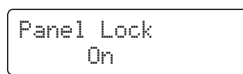

'Panel Lock On' will be shown in the LCD display.

□ Step 2

Press the CONCERT MAGIC and TRANSPOSE buttons simultaneously again to deactivate the panel lock.

The CN42 control panel will return to normal operation.

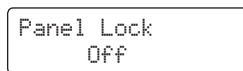

'Panel Lock Off' will be shown in the LCD display.

- When the power is turned off, the Panel Lock function will be released.

3. LESSON FUNCTION

The CN42's Lesson function helps performers to practice the piano with a collection of etudes from Czerny, Burgmüller and Beyer, or songs from *Alfred's Basic Piano Library* and *Alfred's Premier Piano Course* lesson books (USA, Canada, Australia and UK only). It is possible to listen to each etude or song at various tempos, practicing the left and right hand parts separately, before eventually recording a practice session for self-evaluation.

Alfred's Basic Piano Library and *Alfred's Premier Piano Course* lesson books are sold separately. Please check with local dealers or contact Alfred's customer service by telephoning 818-892-2452 (USA & Canada), 0-95240033 (Australia), +44 (0)1279828960 (UK). Or alternatively, by e-mailing customerservice@alfred.com.

1) SELECTING A BOOK/SONG

□ Step 1

Press the LESSON button.

The LED indicator for the LESSON button will turn on to indicate that lesson mode is enabled.

The currently selected book name will be shown in the LCD display.

```
AlfredChild1A-01
Bar= 0- 1 ♩=100
```

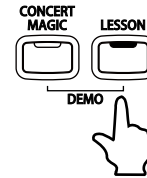

Lesson availability differs according to geographical location:

	Lesson Book Name
US, Canada, UK, Australia	Alfred's Premier Piano Course Lesson 1A
	Alfred's Premier Piano Course Lesson 1B
	Alfred's Basic Piano Library Lesson Book Level 1A
	Alfred's Basic Piano Library Lesson Book Level 1B
	Alfred's Basic Piano Library Lesson Book Level Adult
Rest of the World	Burgmüller 25 (25 Etudes Faciles, Opus 100)
	Czerny 30 (Etudes de Mécanisme, Opus 849)
	Czerny 100 (Hundert Übungsstücke, Opus 139)
	Beyer (Vorschule im Klavierspiel, Opus 101)

□ Step 2

Press the MENU buttons to change the selected lesson book type.



□ Step 3

Press the VALUE buttons to change the selected lesson song.



It is also possible to select a song directly by holding down the LESSON button and pressing a key on the keyboard. Please refer to the separate 'Concert Magic Song List/Lesson Song List' booklet for a complete listing of available lesson songs.

```
AlfredChild1A-01
Bar= 0- 1 ♩=100
```

2) LISTENING TO AND PLAYING A SONG

□ Step 1

Press the PLAY/STOP button to play the selected song.

There will be a one bar count-in before the song starts to play.

Press the PLAY/STOP button to stop the song.

Press the REW button to rewind the song and the FF button to fast forward the song. The bar number and beat number will be shown in the LCD display. Press the RESET button to return to the beginning of the song.

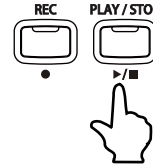

◆ A-B LOOP

The A-B Loop function allows a specific part of a song to be played back repeatedly. While playing back a song, press the LOOP button at the desired loop start point (point A), then press the LOOP button again at the desired loop end point (point B). The recorder will playback the song between point A and point B repeatedly until the PLAY/STOP button is pressed.



■ DUAL or SPLIT sounds cannot be selected in LESSON mode.

◇ EXITING THE LESSON FUNCTION

□ Step 1

Press the LESSON button.

The LED indicator for the LESSON button will turn off, and the unit returns to the normal operation mode.

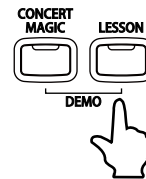

◇ PRACTICING THE LEFT AND RIGHT-HAND PARTS

The volume balance of the left and right-hand parts can be adjusted using the BALANCE slider.

□ Step 1

After selecting a song, move the BALANCE slider to the left or to the right.

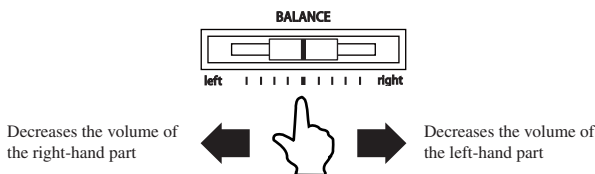

Moving the balance slider partially to the left will gradually decrease the volume of the right-hand part, allowing the right-hand part to be practiced while the pre-recorded part plays softly as a guide. When the balance slider is moved fully to the left, the pre-recorded right-hand part will be muted completely.

◇ ADJUSTING THE TEMPO OF A SONG

□ Step 1

Press and hold the TEMPO button and press the VALUE ▲ or ▼ buttons to increase or decrease the tempo of the song.

3) RECORDING A SONG PRACTICE

Listening to recorded lesson song practice provides an excellent tool for self-evaluation.

□ Step 1

Press the REC button.

The LED indicator for the REC button will start to flash to indicate that the CN42 piano is ready to record.

Recording information will be shown in the LCD display, as below.

```
Record
Bar= 0- 2 1=100
```

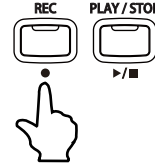

□ Step 2

Press the PLAY/STOP button.

There will be a one bar count-in before the recording starts.

```
Recording
Bar= 4- 2 1=100
```

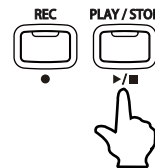

It is recommended to turn on the metronome when recording.

□ Step 3

Press the PLAY/STOP button to stop recording the lesson practice.

◇ PLAYING BACK THE RECORDING

□ Step 1

Press the PLAY/STOP button to listen to the recording.

The performance that has been recorded will be played. The left and right-hand playing volume can be changed using the BALANCE slider.

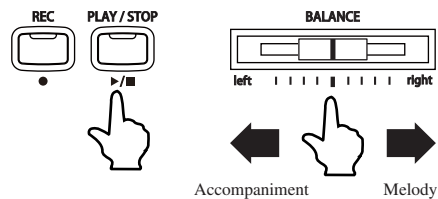

◇ ERASING THE RECORDING

□ Step 1

Press the PLAY/STOP and REC buttons simultaneously to erase the recording.

- Recordings made while using the Lesson Function cannot be saved and are intended for temporary reference only. When changing to another song, exiting the Lesson Function or turning off the CN42 power, Lesson recordings will be erased.
- Preset Lesson songs cannot be permanently overwritten or erased.

4. RECORDER

The RECORDER function records performances in a similar way to that of a tape recorder. However, the CN42 piano records songs as digital data, instead of audio data - storing the music inside the instrument. Because each song is stored digitally, it is possible to modify various aspects during playback, such as adjusting the tempo without changing the pitch, or selecting different sound types and effects settings. Once fully understood, the recorder function provides an easy to use tool for both practicing and playing the piano.

1) RECORDING (REC BUTTON)

The CN42 allows up to three different songs to be recorded, stored in memory, and played back at the touch of a button. Each song has two separate tracks called 'Parts' that can be recorded independently. This allows the left-hand part to be recorded first on one track, then the right-hand part to be recorded later on the other track, while listening to the first part.

When recording or playing back a song, each part (track) can be re-recorded or played back freely. Attempting to re-record a part will automatically erase all previously recorded performance information for that part, therefore when recording parts separately, it is most important to select the correct part carefully, in order to prevent accidentally overwriting a previously recorded part.

- Step 1
Press the REC button.

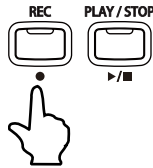

Song, part number, bar and tempo information will be shown in the LCD display.

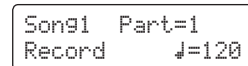

To record a song without making any changes, proceed to step 4.

- Step 2
Press the MENU buttons to select the song (1,2 or 3) to be recorded.

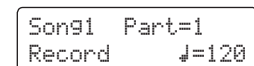
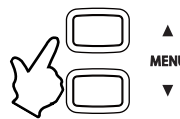

↑↓ MENU buttons

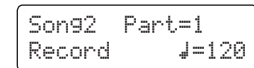

↑↓

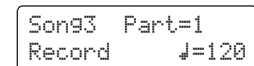

- Step 3
Press the VALUE buttons to select the part number (1 or 2) to be recorded.

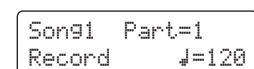

↑↓ VALUE buttons

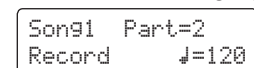

- Step 4
Start to play the piano.

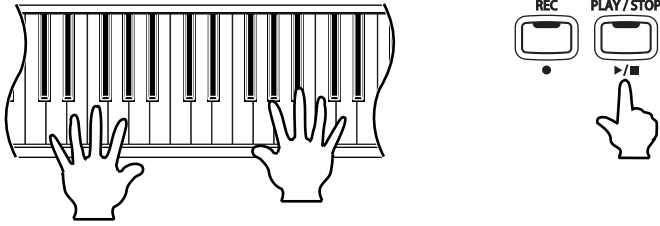

The recorder will automatically start recording with the first note played. During this time, the LED indicators for the REC and PLAY/STOP buttons will be turned on. Any changes made to the sound while recording will also be recorded. The recording can be started by pressing the PLAY/STOP button instead of pressing a key, allowing a blank bar to be inserted at the beginning of a song.

- Step 5
Press the PLAY/STOP button to stop recording.

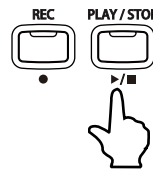

The LED indicators for the PLAY/STOP button and the REC button will turn off and the newly recorded part will be saved to memory automatically. Saving may take a few moments and during this time the piano will not perform any other operations. To record the piece again, simply repeat the above procedure. The new recording will completely erase the previous one.

- The total recording capacity of the CN42 piano's memory is approximately 15,000 notes, with button and pedal presses also counted as one note.
 - When the maximum capacity is reached, recording will stop and all music recorded up until that point will be saved to memory automatically.
- Performance data stored inside the CN42 piano's memory will be saved even after turning off the power.
- Panel operations stored during recording:
 - Changes made to the sound type.
 - Shifts between DUAL and SPLIT modes.
- Panel operations NOT stored during recording:
 - Changes made to effect settings – the selected effect will be applied to the selected sound type.
 - Changes made to tempo.
 - Changes made using the BALANCE slider in DUAL or SPLIT modes – the volume balance set immediately before recording will be stored, however.
 - Turning the TOUCH CURVE or TRANSPOSE functions ON or OFF – regardless of the transpose settings the performance will be replayed at the pitch originally used for the recording.

2) PLAYING BACK A SONG

The PLAY/STOP button is used to start and stop playback of the recorded song, and to also select which song and part is played.

□ Step 1

Press the PLAY / STOP button.

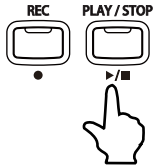

The currently selected song and parts will be shown in the LCD display, and the CN42 piano is ready to playback the song.

```
Song91 Part=1&2*
Bar= 1- 1 ↓=120
```

□ Step 2

Press the MENU buttons to select a song.

An asterisk indicates that the part has been recorded.

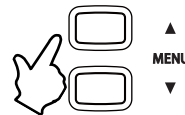

```
Song93 Part=2*
Bar= 1- 1 ↓=120
```

□ Step 3

Press the VALUE buttons to select a part.

- Part 1 & 2 : Both parts will be played back.
- Part 1 : Only Part 1 will be played back.
- Part 2 : Only Part 2 will be played back.



□ Step 4

Press the PLAY/STOP button again and the recorded song will start to play.

Playback information will be shown in the LCD display.

```
Playing
Bar= 2- 1 ↓=120
```

□ Step 5

Press the PLAY/STOP button again to stop playback and return to the song select display.

Press the REW button to rewind the song and the FF button to fast forward the song. The bar number and beat number will be shown in the display. Press the RESET button to return to the beginning of the song.

- While the song is being played, performance information is also sent to supported devices as MIDI data (See page 56). PART1 is sent on 1ch and PART2 is sent on 2ch. When recording in DUAL mode, additional information for PART1 is sent on 9ch and additional information for PART2 is sent on 10ch.

3) TRANSPOSING A SONG

This function allows the currently selected song and songs loaded from a USB device to be transposed.

□ Step 1

Press and hold the TRANSPOSE button, then press the MENU buttons to select the Song Transpose function.

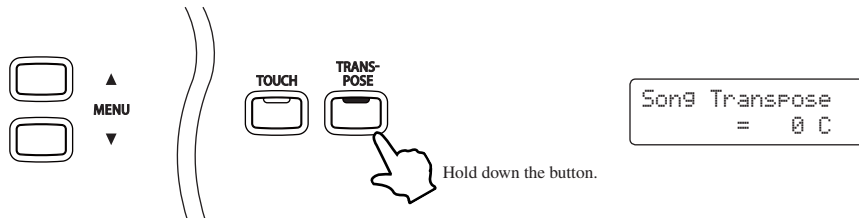

'Song Transpose' and a value of '0 C' will be shown in the LCD display, indicating that the song is in its original key and has not been transposed.

□ Step 2

Press and hold the TRANSPOSE button, then press the VALUE buttons to specify the transposition amount.

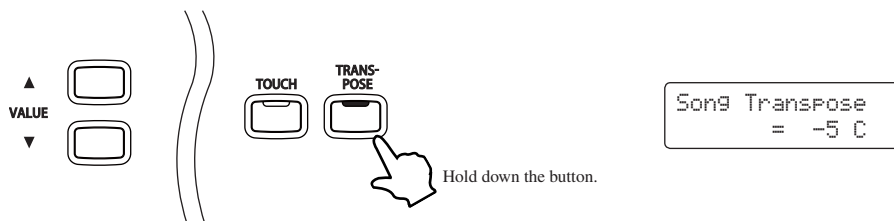

The LCD display will show a number indicating how many half steps up or down the current song has been transposed.

'-5', for example, represents a transposition that is 5 half steps lower.

- The piano can be transposed by up to 12 half steps higher or 12 half steps lower.
- When a different song is selected, the song transposition value will reset to '0 C'.

4) ERASING A SONG

This function allows any songs that are no longer listened to, to be cleared.

□ Step 1

Press the PLAY / STOP and REC buttons simultaneously.

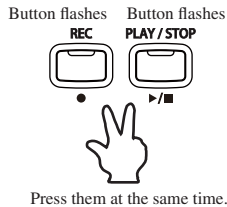

Press them at the same time.

The LED indicators for the PLAY / STOP and REC buttons will start to flash, and song erase information will be shown in the LCD display.

```
To Del Press REC
Song 1 Part=1&2*
```

□ Step 2

Use the MENU buttons to select a song, then use the VALUE buttons to select a part.



□ Step 3

Press the REC button to erase the selected song and part. A confirmation message will be shown in the LCD display.

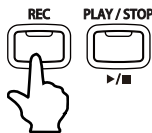

```
Sure? Press REC
Song 1 Part=1&2*
```

□ Step 4

Press the REC button again to confirm erasing the selected song and part.

```
Deleting
Song 1 Part=1&2*
```

* To cancel the erase operation in Step 3, press the PLAY / STOP button.

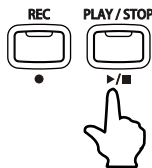

- Repeat the steps above in order to erase a number of songs and parts.
- To erase all songs from memory at once, first turn off the power and then turn it on again, holding down both the REC button and the PLAY/STOP button.

5. USB (TO DEVICE) OPERATIONS

The CN42 includes two USB (to device) ports, allowing USB memory or USB floppy disk drive devices to be connected to the piano. The first connected device will appear as 'USB_A', the second connected device will appear as 'USB_B'. The USB (to device) ports provide a convenient way to playback Standard MIDI File (SMF) songs. There are many sources of SMF songs, including disks for sale from professional musicians and publishers, songs shared among musicians and hobbyists, and Internet websites that feature SMF songs available for download.

In addition, the USB Recorder allows up to 16 independent tracks to be recorded separately.

□ Step 1

After connecting a USB device, press the USB button.

A selection menu will be shown in the LCD display.

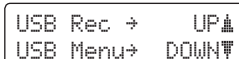

□ Step 2

Press the VALUE ▲ button to enter USB Recorder mode.

Press the VALUE ▼ button to enter the USB Menu.

1) USB RECORDER

◇ PLAYING BACK A SONG

Select a song or directory.

If the USB device contains any SMF song data, a list of the filenames and directories will be shown in the LCD display.

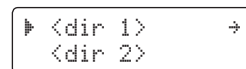
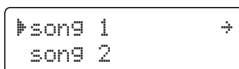

□ Step 1

Press the MENU buttons to scroll through the list of files and directories, then press the VALUE buttons to select the song or enter the directory shown in the first line of the LCD display.



- Select the <DIR UP> entry to return to the previous folder.
- If both 'USB_A' and 'USB_B' devices are connected, an option to select the active device will also be shown in the first line of the LCD display.

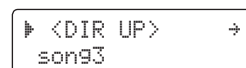
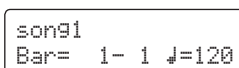

- It is also possible to adjust the key of the selected song by using the Transpose Song function. Please refer to page 36 for more information.

□ Step 2

Press the PLAY/STOP button to playback the selected song.

Press and hold the TEMPO button and press use the VALUE buttons to increase or decrease the tempo of the selected song. The current tempo will be shown in the LCD display.

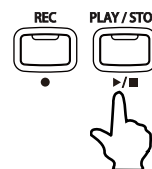

- To playback all of the songs in a directory, press and hold the PLAY/STOP button for a few seconds.

□ Step 3

Press the PLAY/STOP button again to stop the song.

Press the REW button to rewind the song and the FF button to fast forward the song. The bar number and beat number will be shown in the display. Press the RESET button to return to the beginning of the song.

■ A-B LOOP

The A-B Loop function allows a specific part of a song to be played back repeatedly. While playing back a song, press the LOOP button at the desired loop start point (point A), then press the LOOP button again at the desired loop end point (point B). The recorder will playback the song between point A and point B repeatedly until the PLAY/STOP button is pressed.



◇ MUTING A PART

Each of the 16 parts can be muted separately.

- **Step 1**
Press one of the VALUE buttons.



The 16 parts will be shown in the LCD display.

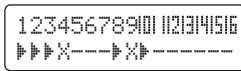

- **Step 2**
Press the MENU buttons to move the cursor, then press the VALUE buttons to set whether the part will be muted or played.

▶ : The part is played. X : The part is muted. – : The part is empty.

■ If no button is pressed for more than two seconds, the LCD display will return to the previous screen.

◇ RECORDING A SONG

The USB Recorder allows up to 16 independent tracks to be recorded separately.

- **Step 1**
After connecting a USB device and pressing the USB button, press the VALUE ▲ button to enter USB Recorder mode.

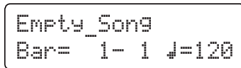

■ If the USB device is empty, 'Empty_Song' will be shown on the first line of the LCD display.

Press the MENU buttons to scroll through the list of files and directories, then press the VALUE button to select 'Empty_Song'.

- **Step 2**
Press the REC button.

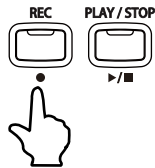

Recording information will be shown in the LCD display.

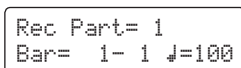

- **Step 3**
Press the VALUE buttons to select a recording part.

■ Part 10 is reserved as a drum track. When selecting Part 10, only drum sounds can be played. Similarly, drum sounds can only be played on Part 10.

■ When the Rec Part is set to MIDI, all data received from the MIDI IN jack will be recorded on Part 1 to Part 16, according to the MIDI channel.

Step 4

Begin playing the keyboard or press the PLAY / STOP button to start recording.
Press the PLAY/STOP button again to stop recording.

 Step 5

Press the REC button again and select another recording part to continue recording other parts.

When a part has been recorded, an asterisk (*) will appear beside the part number in the LCD display.

```
Rec Part= 1*
Bar= 1- 1 ♪=120
```

◇ ADJUSTING THE VOLUME LEVEL OF THE USB RECORDER

This function allows the volume level of the USB Recorder playback to be adjusted, and may prove useful when wishing to play along with the USB Recorder song as an accompaniment.

 Step 1

Press and hold the USB button.

Recording information will be shown in the LCD display.

```
USB Recorder
Total Volume=100
```

 Step 2

While holding the USB button, press the VALUE buttons to adjust the volume level of the USB Recorder.

The volume level of USB Recorder songs can be changed from 0 to 100.

◇ SAVING THE RECORDED SONG TO THE USB DEVICE

When selecting another song, or pressing the USB button to exit the USB Recorder, a save prompt will be shown in the LCD screen.

```
Save to USB DRV?
Yes→REC No→STOP
```

 Step 1

Press the REC button to save the recorded song to the USB device.

Song Name information will be shown in the LCD screen.

```
SongName
NEWSONG001 →REC
```

 Step 2

Press the MENU buttons to move the cursor, and the VALUE buttons to choose a character to name the recorded song.

 Step 3

Press the REC button again to save the recorded song to the USB device.

'Executing...' and then 'Complete!' will be shown in the LCD display.

Alternatively, press the STOP at the previous step to select another song or exit the USB Recorder. The recorded song data will be erased.

2) USB MENU

There are six USB Menus. Press the MENU buttons to select a USB Menu, then press one of the VALUE buttons to enter the selected USB Menu. Press the STOP button to return to the previous menu.

Do not attempt to disconnect USB devices while being accessed. Doing so may result in data loss or permanent damage.

◇ 1. INTERNAL SONG SAVE

This menu can be used to save songs recorded in the CN42 piano's internal recorder to a USB device.

□ Step 1

Press the VALUE buttons to select the song to be saved, then press the REC button.

```
Int Song Save
Song1      →REC
```

□ Step 2

Press the MENU buttons to move the cursor, and the VALUE buttons to choose a character to name the recorded song, then press the REC button.

```
Int Song Rename
NewSong   →REC
```

□ Step 3

Press the MENU buttons to scroll through the list of files and directories, then press the VALUE button to select the destination directory in which to save the internal song.

□ Step 4

Press the REC button again to save the recorded song to the USB device.

'Executing...!' and then 'Complete!' will be shown in the LCD display.

◇ 2. RENAME

This menu can be used to rename songs and directories stored on a USB device.

□ Step 1

Press the MENU and VALUE buttons to scroll through the list of files and directories, then press the REC button to select the song or directory to be renamed.

```
Rename
Song1   →REC
```

□ Step 2

Press the MENU buttons to move the cursor, and the VALUE buttons to choose a character to rename the recorded song.

```
Rename
Song2   →REC
```

□ Step 3

Press the REC button again to rename the recorded song stored on the USB device.

'Executing...!' and then 'Complete!' will be shown in the LCD display.

◇ 3. DELETE

This menu can be used to delete songs and empty directories stored on a USB device.

□ Step 1

Press the MENU and VALUE buttons to scroll through the list of files and directories, then press the REC button to select the song or directory to be deleted.

A delete confirmation request will be shown in the LCD display.

```
Sure?
Yes→REC No→STOP
```

Press the PLAY/STOP button to cancel.

□ Step 2

Press the REC button again to delete the recorded song from the USB device.

'Executing...' and then 'Complete!' will be shown in the LCD display.

◇ 4. SONG COPY

This menu can be used to copy a song to another floppy disk (when using a USB floppy disk drive), or to make a copy of a song on the same USB device.

□ Step 1

Press the MENU and VALUE buttons to scroll through the list of files and directories, then press the REC button to select the song to be copied.

'Reading...' will appear briefly, then a confirmation request will be shown in the LCD display.

```
Ready to Copy
Song001 →REC
```

When using a USB floppy disk drive, eject the floppy disk and insert another floppy disk, in order to copy the song to another floppy disk.

□ Step 2

Press the MENU buttons to move the cursor, and the VALUE buttons to choose a character to name the recorded song, then press the REC button.

□ Step 3

Press the MENU and VALUE buttons to scroll through the list of files and directories to select the destination for the song to be copied to.

□ Step 4

Press the REC button to copy the recorded song the USB device.

'Executing...' and then 'Complete!' will be shown in the LCD display.

■ Copying a song to another device is only possible when both 'USB_A' and 'USB_B' devices are connected.

◇ 5. MAKE DIR

This menu can be used to make new directories on a USB device.

□ Step 1

Press the MENU and VALUE buttons to scroll through the list of files and directories, then press the REC button to select the destination for the directory to be made.

```
Dir Name
userdir
```

□ Step 2

Press the MENU buttons to move the cursor, and the VALUE buttons to choose a character to rename the new directory.

```
Dir Name
mydir
```

□ Step 3

Press the REC button again to make a new directory on the USB device.

'Executing...' and then 'Complete!' will be shown in the LCD display.

◇ 6. FORMAT

This menu can be used to format a USB device for use in the CN42 piano.

□ Step 1

Press the VALUE buttons to select the USB device to be formatted.

The connected USB devices will be shown in the LCD display.

```
Format   USB_A▲
         USB_B▼
```

□ Step 2

Press the REC button.

A format confirmation request will be shown in the LCD display.

Press the PLAY/STOP button to cancel.

```
Format   USB_A
Yes→REC No→STOP
```

□ Step 3

Press the REC button again to format the selected USB device.

'Executing...' and then 'Complete!' will be shown in the LCD display.

6. MENU FUNCTIONS

The Menu Functions allow various parameters for controlling the CN42 piano's tuning, system and MIDI functions to be adjusted.

1) Brilliance	12) Key of Temperament
2) Lower Octave Shift	13) MIDI Channel
3) Lower Pedal On/Off	14) Transmit Program Change On/Off
4) Layer Octave Shift	15) Local Control On/Off
5) Layer Dynamics	16) Multi-Timbral Mode On/Off
6) Damper Hold	17) Channel Mute (MIDI Ch. On/Off)
7) Damper Effect	18) Sending Program Change Numbers
8) String Resonance	19) MIDI Clock
9) Four Hands On/Off	20) User Memory
10) Tuning	21) Factory Reset
11) Temperament	

When the MENU ▲ button is pressed, the first menu item is displayed. When the MENU ▼ is pressed, the last menu item is displayed. Press the MENU buttons to scroll through the various menu items in ascending / descending order.

1) BRILLIANCE

This function allows the brightness of the sound to be adjusted.

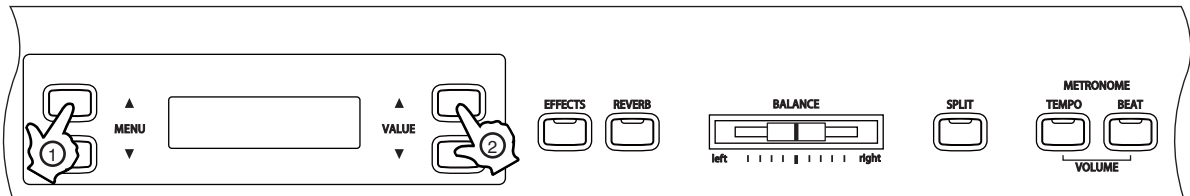

□ Step 1

Press the MENU buttons to select the Brilliance function.

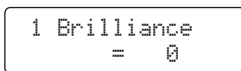

The value will be shown on the second line of the LCD display.

□ Step 2

Press the VALUE buttons to select the desired Brilliance value.

The Brilliance value can be set within the range of -10 to +10.

Plus settings produce a brighter tone, minus settings produce a mellower tone.

□ Step 3

Press any one of the SOUND SELECT buttons to exit the menu.

- The Brilliance function will return to the default setting of '0' each time the power is turned off.
- Use the User Memory function (page 63), to save the desired brilliance setting, allowing the current brilliance setting to remain even after the power is turned off.

2) LOWER OCTAVE SHIFT

This function allows the lower part to be raised by one, two, or three octaves when using SPLIT mode.

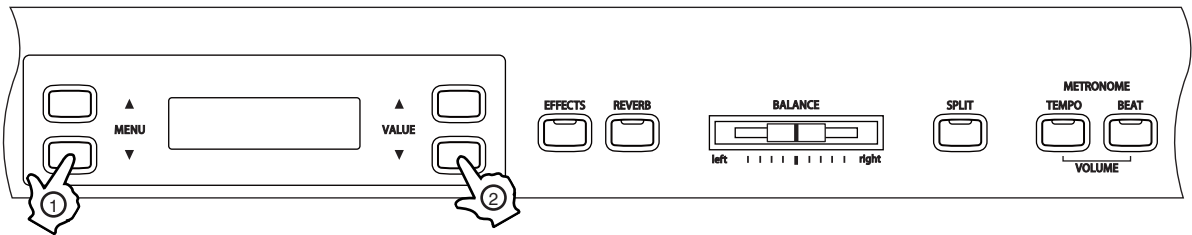

□ Step 1

Press the MENU buttons to select the Lower Octave Shift function.

```
2 LowerOctShift
= 0
```

The Lower Octave Shift value will be shown on the second line of the LCD display.

□ Step 2

Press the VALUE buttons to set the desired Lower Octave Shift value.

The value can be set within the range of 0 to +3.

□ Step 3

Press any one of the SOUND SELECT buttons to exit the menu.

- The Lower Octave Shift function will return to the default setting of '0' each time the power is turned off.
- Use the User Memory function (page 63), to save the desired Lower Octave Shift setting, allowing the current Lower Octave Shift setting to remain even after the power is turned off.

3) LOWER PEDAL ON / OFF

This function determines whether the sustain pedal will be active for lower part sound when in SPLIT mode. The default setting is OFF, which means the sustain pedal is not active for lower part sound.

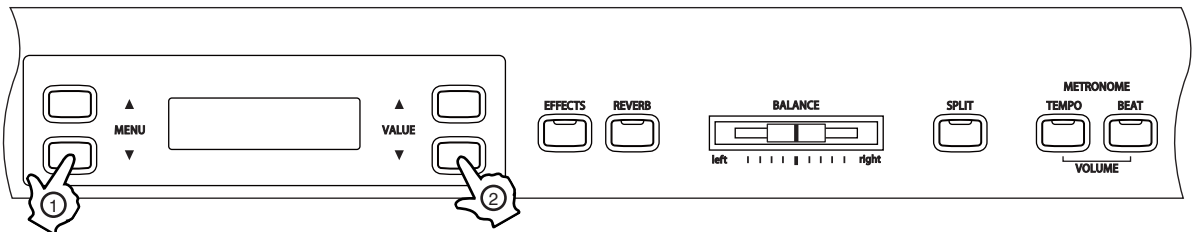

□ Step 1

Press the MENU buttons to select the Lower Pedal ON/OFF function.

ON or OFF will be shown on the second line of the LCD display.

```
3 Lower Pedal
= Off
```

□ Step 2

Press the VALUE buttons to turn the Lower Pedal Function ON or OFF.

When set to ON, the sustain pedal is active for the lower sound when the pedal is depressed.
When set to OFF, the sustain pedal will not be active for the lower sound when the pedal is depressed, however the sustain pedal will still be active for the upper sound.

□ Step 3

Press any one of the SOUND SELECT buttons to exit the menu.

- The Lower Pedal ON/OFF function will return to the default setting of 'OFF' each time the power is turned off.
- Use the User Memory function (page 63), to save the desired Lower Pedal ON/OFF setting, allowing the current Lower Pedal ON/OFF setting to remain even after the power is turned off.

4) LAYER OCTAVE SHIFT

This function allows the octave of a layered sound (the sound displayed in the second line of the LCD display) to be raised or lowered by one octave when using DUAL mode.

For example, when playing in dual mode using Concert Grand Piano and String Ensemble sounds, the octave range for the String Ensemble sound can be raised or lowered.

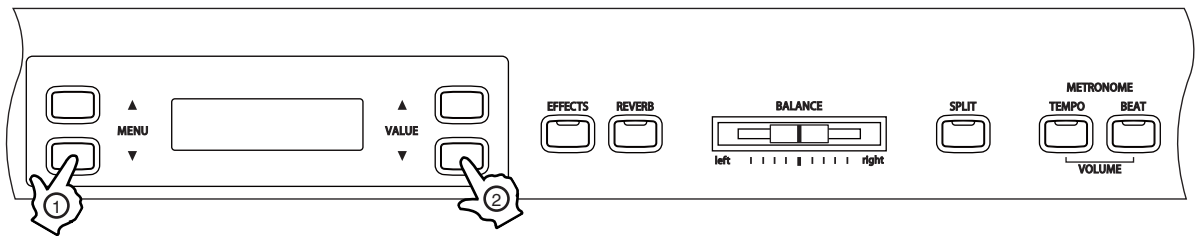

□ Step 1

Press the MENU buttons to select the Layer Octave Shift function.

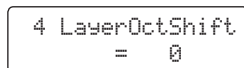

The Layer Octave Shift value will be shown on the second line of the LCD display.

□ Step 2

Press the VALUE buttons to set the desired Layer Octave Shift value.

The value can be set within the range of -2 to +2.

Minus values select an octave range one or two octaves lower. Positive values select an octave range one or two octaves higher.

The octave for the sound displayed in the second line of the LCD display when using DUAL mode will be changed.

- For some sounds it may not be possible to select a higher octave range.

□ Step 3

Press any one of the SOUND SELECT buttons to exit the menu.

- The Layer Octave Shift function will return to the default setting of 'OFF' each time the power is turned off.
- Use the User Memory function (page 63), to save the desired Layer Octave Shift setting, allowing the current Layer Octave Shift setting to remain even after the power is turned off.

5) LAYER DYNAMICS

When using DUAL mode, sometimes simply adjusting the volume balance between the two layered sounds is not enough to create the desired sound character, especially if both sounds are very dynamic. Two equally dynamic sounds can be difficult to control and play comfortably.

The Layer Dynamics Function allows the overall dynamic sensitivity of the layered sound to be limited, in order to create a perfect blend between both sounds in the layer. In addition to reducing the volume of the layered sound, limiting the dynamic sensitivity of the layered sound also allows the layered sound to be controlled more easily in relation to the main sound.

For example, when playing Concert Grand Piano and String Ensemble sounds simultaneously using DUAL mode, the Layer Dynamics function can be used to adjust the String Ensemble dynamics.

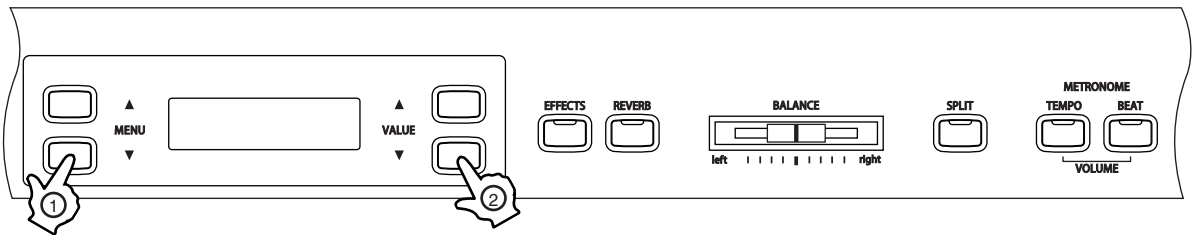

□ Step 1

Press the MENU buttons to select the Layer Dynamics function.

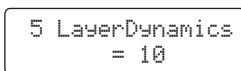

The Layer Dynamics value will be shown on the second line of the LCD display.

□ Step 2

Press the VALUE buttons to set the desired Layer Dynamics value.

The value can be set within the range of 1 to 10.

A value of 1 produces the greatest reduction in dynamics and a value of 10 produces no change in the dynamics.

The default value is 10.

□ Step 3

Press any one of the SOUND SELECT buttons to exit the menu.

- The Layer Dynamics function will return to the default setting of '10' each time the power is turned off.
- Use the User Memory function (page 63), to save the desired Layer Dynamics setting, allowing the current Layer Dynamics setting to remain even after the power is turned off.

6) DAMPER HOLD ON / OFF

This function determines whether sounds such as organ or strings should be held (ON) or gradually decay (OFF) when the damper pedal is depressed.

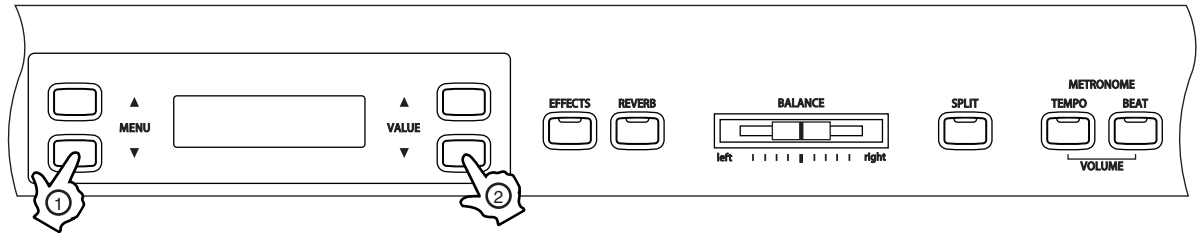

□ Step 1

Press the MENU buttons to select the Damper Hold ON/OFF function.

```
6 Damper Hold
  = Off
```

ON or OFF will be shown on the second line of the LCD display.

□ Step 2

Press the VALUE buttons to turn the Damper Hold function ON or OFF.

When set to ON and the sustain pedal is depressed, sustained sounds will be sustained even after the keys are released.

When set to OFF and the sustain pedal is depressed, sustained sounds will begin to decay (fade out) after the keys are released.

□ Step 3

Press any one of the SOUND SELECT buttons to exit the menu.

- The Damper Hold ON/OFF function will return to the default setting of 'OFF' each time the power is turned off.
- Use the User Memory function (page 63), to save the desired Damper Hold ON/OFF setting, allowing the current Damper Hold ON/OFF setting to remain even after the power is turned off.

7) DAMPER EFFECT

When the sustain pedal is depressed on an acoustic piano, all the dampers are lifted up allowing the strings to vibrate freely. When you play note or chord on the piano with the sustain pedal depressed not only will the strings for the notes you played vibrate but other strings will vibrate in sympathetic resonance. The Damper Effect function simulates the phenomenon.

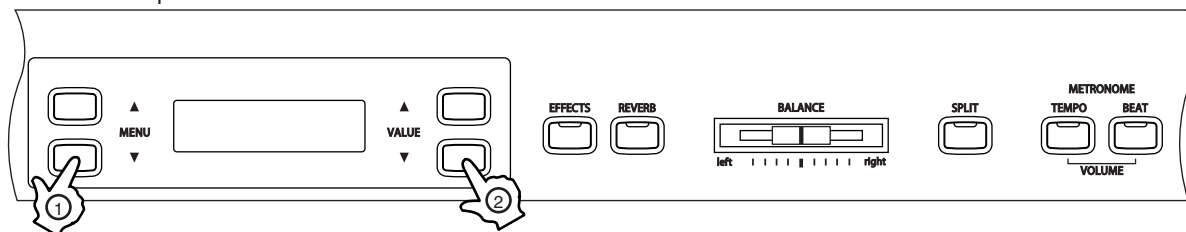

□ Step 1

Press the MENU buttons to select the Damper Effect function.

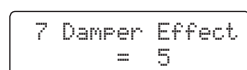

The Damper Effect value will be shown on the second line of the LCD display.

□ Step 2

Press the VALUE buttons to set the desired Damper Effect value.

You can select the level of effect from off, 1 to 10. The default setting is 5.

□ Step 3

Press any one of the SOUND SELECT buttons to exit the menu.

- The Damper Effect function will return to the default setting of '5' each time the power is turned off.
- Use the User Memory function (page 63), to save the desired Damper Effect setting, allowing the current Damper Effect setting to remain even after the power is turned off.

8) STRING RESONANCE

The string resonance function simulates the phenomenon of string resonance on an acoustic piano. You can adjust the volume of the string resonance.

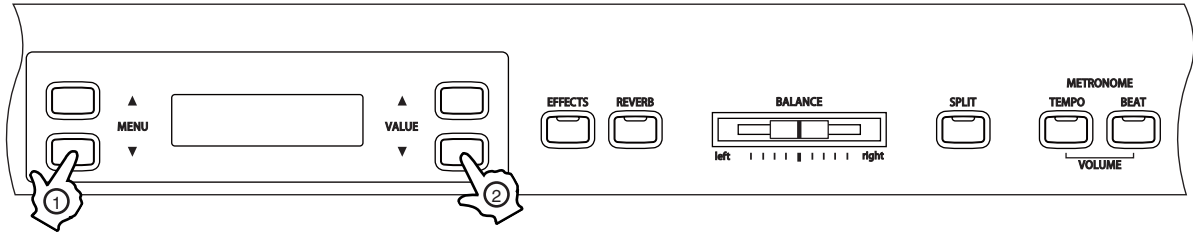

□ Step 1

Press the MENU buttons to select the String Resonance function.

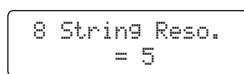

The String Resonance value will be shown on the second line of the LCD display.

□ Step 2

Press the VALUE buttons to set the desired String Resonance value.

5 is the default setting.

String resonance will not be active when 'Off' is selected.

□ Step 3

Press any one of the SOUND SELECT buttons to exit the menu.

■ About string resonance

Even when the sustain pedal is not depressed on an acoustic piano, the strings for any notes you are holding will be un-damped and will resonate freely in sympathy with the strings of other notes that you play if they are part of the same harmonic series. In addition, adjacent notes will also be resonated. The string resonance function simulates this phenomenon. This is called "string resonance."

For example, when you play the keys shown below while holding down the C key, the string of the C key resonates and produces a sound.

(Quietly press and hold down the C key, and then quickly tap each of the keys shown below. You can hear the string resonate.)

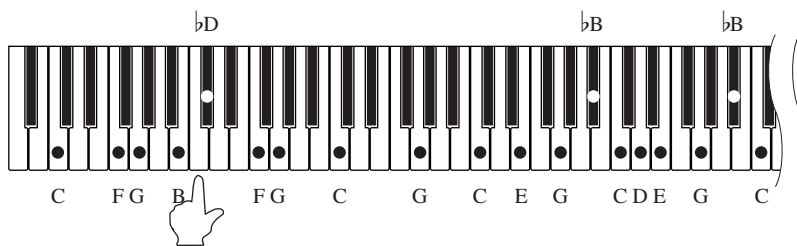

Play and hold a 'C' note.

- When you play a key while holding down an adjacent key, an acoustic piano produces a sound as a result of string resonance. The CN42 simulates this phenomenon.
- The String Resonance function will return to the default setting of '5' each time the power is turned off.
- Use the User Memory function (page 63), to save the desired String Resonance setting, allowing the current String Resonance setting to remain even after the power is turned off.
- String resonance is not active when the sustain pedal is depressed.
- The string resonance function is effective only for the acoustic piano sounds.

9) FOUR HANDS ON/OFF

This function allows FOUR HANDS mode to be activated or deactivated using an alternative method to that described on page 16.

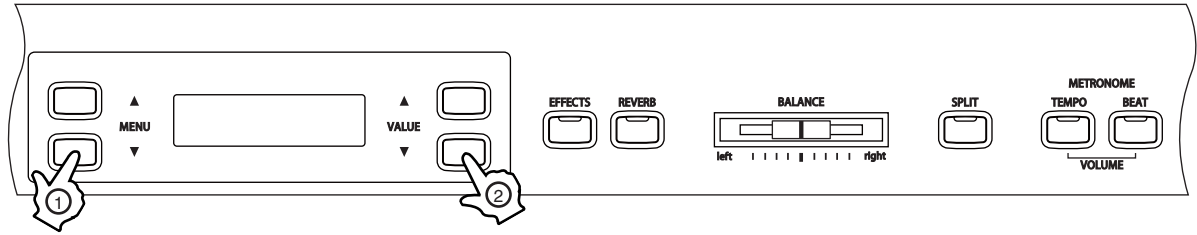

□ Step 1

Press the MENU buttons to select the FOUR HANDS ON/OFF function.

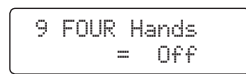

ON or OFF will be shown on the second line of the LCD display.

□ Step 2

Press the VALUE buttons to turn the FOUR HANDS function ON or OFF.

□ Step 3

Press any one of the SOUND SELECT buttons to exit the menu.

- The FOUR HANDS ON/OFF function will return to the default setting of 'OFF' each time the power is turned off.
- Use the User Memory function (page 63), to save the desired FOUR HANDS ON/OFF setting, allowing the current FOUR HANDS ON/OFF setting to remain even after the power is turned off.

10) TUNING

This function allows the piano's pitch to be finely adjusted, and may prove useful when playing with other instruments.

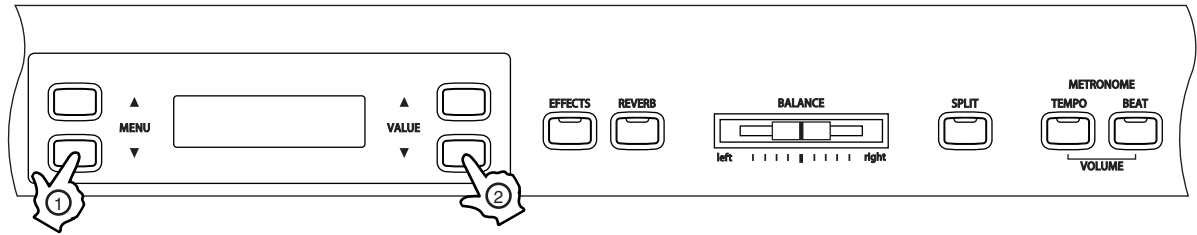

□ Step 1

Press the MENU buttons to select the Tuning function.

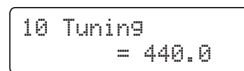

The Tuning value will be shown on the second line of the LCD display.

□ Step 2

Press the VALUE buttons to set the desired Tuning value.

The value can be set within the range of 427.0 to 453.0 (Hz).

The pitch will be changed by 0.5 Hz each time one of the VALUE buttons is pressed.

□ Step 3

Press any one of the SOUND SELECT buttons to exit the menu.

- The Tuning function will return to the default setting of '440.0 Hz' each time the power is turned off.
- Use the User Memory function (page 63), to save the desired Tuning setting, allowing the current Tuning setting to remain even after the power is turned off.

11) TEMPERAMENT

The CN42 piano offers immediate access to a variety of musical temperaments popular during the Renaissance and Baroque periods. It may prove interesting and educational to experiment with different temperaments, other than the modern 'equal temperament' standard this is dominant in music today.

The following temperaments are available:

<ul style="list-style-type: none"> ◆ Equal temperament (piano) (Equal P. only) 	<p>This is the default temperament. If a piano sound is selected the tuning is stretched like an acoustic piano (EQUAL TEMPERAMENT). If any other type of sound is selected the tuning will be EQUAL (FLAT). An explanation of EQUAL TEMPERAMENT and EQUAL TEMPERAMENT (FLAT) is provided later in this section.</p> <p>If a piano sound is used in a layer with any other sound, then both sounds will use the EQUAL TEMPERAMENT (stretched) tuning.</p>
<ul style="list-style-type: none"> ◆ Pure temperament <major> (Pure major) ◆ Pure temperament <minor> (Pure minor) 	<p>This temperament, which eliminates dissonances for thirds and fifths, is still popular for choral music because of its perfect harmony.</p> <p>Performers must be aware which key they are playing in when using this temperament.</p> <p>Any key modulation will result in dissonances. When playing music in a particular key, the key of the temperament must also be correctly matched.</p> <p>When playing in a major key select Pure (Major) and when playing in a minor key select Pure (minor).</p>
<ul style="list-style-type: none"> ◆ Pythagorean temperament (Pythagorean) 	<p>This temperament, which uses mathematical ratios to eliminate dissonance for fifths, is very limited for use with chords, but it produces very characteristic melodic lines.</p>
<ul style="list-style-type: none"> ◆ Meantone temperament (Meantone) 	<p>This temperament, which uses a mean between a major and minor whole tone to eliminate dissonance for thirds, was devised to eliminate the lack of consonances experienced with certain fifths for the Mersenne pure temperament. It produces chords that are more beautiful than those with the equal temperament.</p>
<ul style="list-style-type: none"> ◆ Werckmeister III temperament (Werckmeister) ◆ Kirnberger III temperament (Kirnberger) 	<p>These two temperaments are placed in between Meantone and Pythagorean.</p> <p>For music with few accidentals, this temperament produces the beautiful chords of the mean tone, but as accidentals increase, the temperament produces the characteristic melodies of the Pythagorean temperament. It is used primarily for classical music written in the Baroque era to revive the original characteristics.</p>
<ul style="list-style-type: none"> ◆ Equal temperament (flat) (Equal Flat) 	<p>This is an 'unstretched' equal temperament that divides the scale into twelve equal semitones. This produces the same chordal intervals in all twelve keys, and has the advantage of limitless modulation of the key. However the tonality of each key becomes less characteristic and no chord is in pure consonance.</p>
<ul style="list-style-type: none"> ◆ Equal temperament 	<p>This is the most popular piano temperament. The hearing ability of a human is uneven and is not as accurate with high frequency and low frequency as it is with the middle range. This temperament's tuning is stretched to compensate for this so the sound will be heard naturally to the ears. This 'stretched' equal temperament is a practical variation of the 'unstretched' equal temperament which was invented on a mathematical basis.</p>

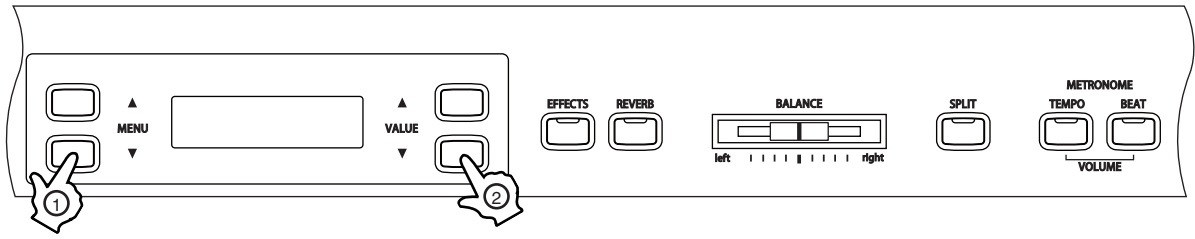

- Step 1
Press the MENU buttons to select the Temperament function.

```
11 Temperament
= Equal(P.only)
```

The Temperament type will be shown on the second line of the LCD display.

- Step 2
Press the VALUE buttons to set the desired Temperament type.

■ Equal temperament

```
11 Temperament
= Equal(P.only)
```

↑↓ VALUE buttons

■ Pure temperament <major>

```
11 Temperament
= Pure(Major)
```

■ Pure temperament <minor>

```
11 Temperament
= Pure(minor)
```

■ Pythagorean temperament

```
11 Temperament
= Pythagorean
```

■ Meantone temperament

```
11 Temperament
= Meantone
```

■ Equal temperament

```
11 Temperament
= Equal
```

■ Equal temperament (flat)

```
11 Temperament
= Equal(Flat)
```

■ Kirnberger III temperament

```
11 Temperament
= Kirnberger
```

■ Werckmeister III temperament

```
11 Temperament
= Werckmeister
```

■ After selecting the desired temperament type, please read '12) KEY OF TEMPERAMENT' (page 55) for information regarding the key signature for the temperament, before continuing.

- Step 3
Press any one of the SOUND SELECT buttons to exit the menu.

- The Temperament type will return to the default setting of 'Equal Temperament (Piano)' each time the power is turned off.
- Use the User Memory function (page 63), to save the desired Temperament setting, allowing the current Temperament setting to remain even after the power is turned off.

12) KEY OF TEMPERAMENT

Limitless modulation of the key became available only after the invention of equal temperament. When using a temperament other than equal temperament, care must be taken to choose the key signature to play in. For example, if the song to be played is written in D major, 'D' would be chosen as the temperament key.

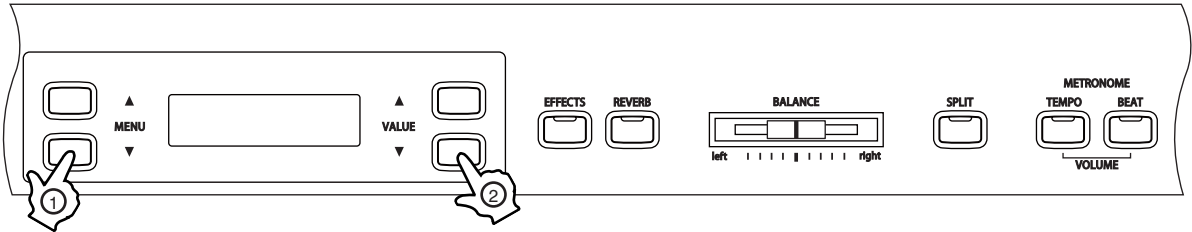

□ Step 1

Press the MENU buttons to select the Key of Temperament function.

```
12 Key of Temper
= C
```

The Temperament Key will be shown on the second line of the LCD display.

□ Step 2

Press the VALUE buttons to set the desired Key of Temperament.

The key can be set within the range of C to B.

Please note that changing the key of the temperament will only change the 'balance' of the tuning, the pitch of the keyboard will remain unchanged.

The key of temperament function will have no effect when equal temperament is selected.

□ Step 3

Press any one of the SOUND SELECT buttons to exit the menu.

- The Key of Temperament will return to the default setting of 'C' each time the power is turned off.
- Use the User Memory function (page 63), to save the desired Key of Temperament setting, allowing the current Key of Temperament setting to remain even after the power is turned off.

◇ MIDI OVERVIEW

The term MIDI is an acronym for Musical Instrument Digital Interface, an international standard for connecting synthesizers, sequencers (MIDI recorders) and other electronic instruments so that they can exchange performance data.

The CN42 is equipped with two MIDI jacks for exchanging data: MIDI IN and MIDI OUT. Each uses a special cable with a DIN connector.

- MIDI IN : For receiving note, program change and other data.
- MIDI OUT : For sending note, program change and other data.
- MIDI THRU : For passing along MIDI data received to another MIDI instrument without processing.

MIDI uses channels to exchange data back and forth between MIDI devices. There are receive (MIDI IN) and transmit (MIDI OUT) channels. Most musical instruments or devices with MIDI functions are equipped with both MIDI IN and OUT jacks and are capable of transmitting and receiving data via MIDI.

The receive channels are used to receive data from another MIDI device and the transmit channels are used to transmit data to another MIDI device.

■ CONNECTION TO AN EXTERNAL SEQUENCER

When connected as shown in the illustration below, songs played on the CN42 can be recorded using a MIDI recorder, with preset sounds (such as piano, harpsichord and vibraphone, etc.) controlled by the CN42's MULTITIMBRAL MODE function to create a multi-layer MIDI recording.

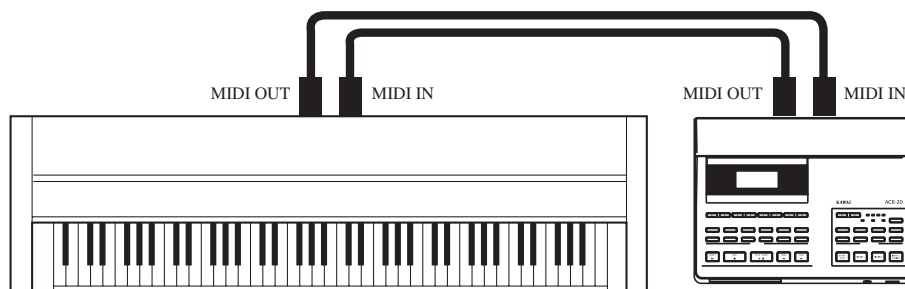

◇ CN42 MIDI FUNCTIONS

Transmit / receive keyboard note information	By transmitting MIDI data from the CN42 piano (MIDI out) a MIDI-connected keyboard can be played from the CN42 piano. Or alternatively, by receiving data (MIDI IN), the CN42 piano can be played from another MIDI-connected keyboard or device.
Transmit / receive channel setting	Specify transmit/receive channels within the range of 1 to 16.
Transmit / receive Program change (sound type) number	Transmit/receive program change data to/from a MIDI-connected musical instrument or device.
Transmit / receive pedal data	Transmit/receive sustain pedal and sustain pedal data from a MIDI-connected musical instrument or device. Sostenuto pedal data can also be transmitted.
Receive volume data	The CN42 piano will respond to MIDI volume data sent from a MIDI-connected musical instrument or device.
Multi-timbral setting	The CN42 piano is able to receive multiple channel MIDI data from a MIDI-connected musical instrument or device, when multi-timbral mode is turned on.
Transmit / receive exclusive data	Transmit/receive front panel or menu function settings as exclusive data.
Transmit recorder playback data	Songs recorded using the recorder can be played back from a MIDI-connected musical instrument or recorded by an external sequencer via the MIDI OUT jack.

Please refer to the 'MIDI IMPLEMENTATION CHART' (page 80) for further information regarding the CN42's MIDI functions.

13) MIDI CHANNEL

This function is used to determine on which MIDI channel the CN42 piano will exchange MIDI information with external MIDI devices and instruments or a personal computer.

The selected channel will function as both the transmit and receive channel.

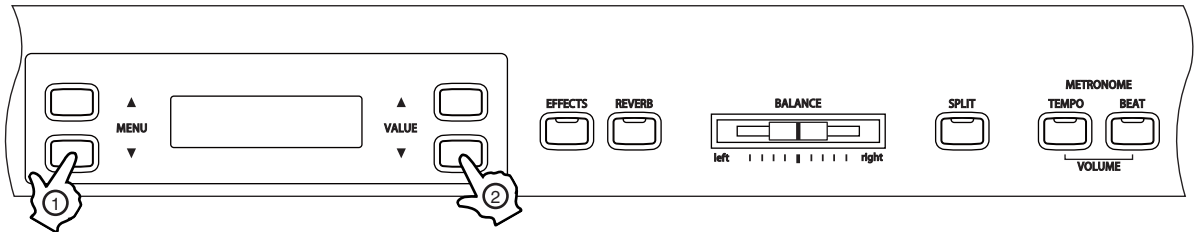

□ Step 1

Press the MENU buttons to select the MIDI channel function.

```
13 MIDI Channel
= 1 (TRS/RCU)
```

The current MIDI channel will be shown on the second line of the LCD display.

□ Step 2

Press the VALUE buttons to select the desired MIDI channel.

The MIDI channel can be set within the range of 1 to +16.

□ Step 3

Press any one of the SOUND SELECT buttons to exit the menu.

■ The CN42 piano's MIDI channel setting defaults to receiving MIDI channel information from all channels, 1 to 16, each time the power is turned on. This is called 'omni mode on'. The CN42 piano will switch to 'omni mode off' when a specific channel is selected using the MIDI channel function, and data will only be received on that specified channel. In order to specify channel 1 in the 'omni mode off' state, first select channel 2, then select channel 1.

■ When multi-timbral mode is on (page 60):

When playing in split mode with Multi-timbral mode ON

: Notes played in the lower section of the keyboard will be transmitted on the channel that is one channel higher than the selected channel. For example, with the MIDI channel is set to 3 notes played in the lower section of the keyboard will be transmitted on channel 4.

When playing in dual mode : The notes played will be transmitted on two channels, the selected channel and the channel that is one channel higher. When channel the selected MIDI channel is 16, channel 1 will be used to transmit notes for the layered part.

14) TRANSMIT PROGRAM CHANGE ON / OFF

This function determines whether the CN42 piano will transmit program change information when pressing the SOUND SELECT buttons.

When set to ON and with Multi-Timbral mode set to OFF or ON1, pressing the SOUND SELECT buttons will send the program change numbers listed in the left half of the chart on page 69 to 75 via MIDI.

When Multi-Timbral mode is set to ON2, pressing the SOUND SELECT buttons will send the program change numbers listed in the right half of the chart on page 69 to 75 via MIDI.

In addition to SOUND SELECT buttons, other button operations such as Touch Curve, DUAL, Digital Effect, and Reverb settings can also be transmitted as MIDI exclusive data when the corresponding buttons are pushed.

When set to OFF no program change or other panel information will be transmitted via MIDI.

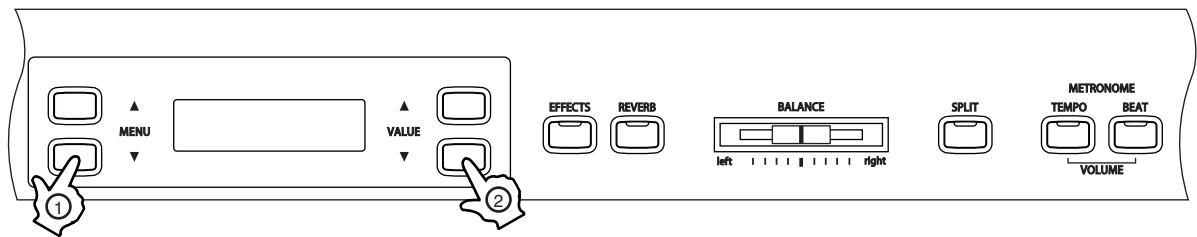

■ Please refer to page 60 for information regarding Multi-Timbral mode.

□ Step 1

Press the MENU buttons to select the Transmit Program Change ON/OFF function.

```
14 Transmit PGM
= On
```

ON or OFF will be shown on the second line of the LCD display.

□ Step 2

Press the VALUE buttons to turn the Transmit Program Change function ON or OFF.

□ Step 3

Press any one of the SOUND SELECT buttons to exit the menu.

- The Transmit Program Change ON/OFF function will return to the default setting of 'ON' each time the power is turned off.
- Use the User Memory function (page 63), to save the desired Transmit Program Change ON/OFF setting, allowing the current Transmit Program Change ON/OFF setting to remain even after the power is turned off.
- When using DUAL or SPLIT mode, ON, OFF information and sound type settings for each mode are transmitted as exclusive data, but program numbers will not be transmitted.
Program numbers will also be transmitted when Multi-Timbral mode is on.

15) LOCAL CONTROL ON / OFF

This function determines whether the CN42 piano's sound will be played from the piano's keyboard (ON) or only from an external MIDI device (OFF). Even with local control set to OFF the CN42 piano's keyboard will still transmit on the selected MIDI channel to an external MIDI device or personal computer.

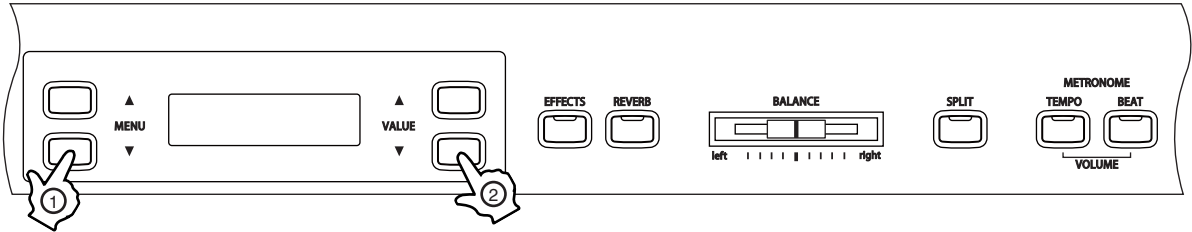

□ Step 1

Press the MENU buttons to select the Local Control ON/OFF function.

```
15 Local Control
= On
```

ON or OFF will be shown on the second line of the LCD display.

□ Step 2

Press the VALUE buttons to turn the Local Control function ON or OFF.

□ Step 3

Press any one of the SOUND SELECT buttons to exit the menu.

- The Local Control ON/OFF function will return to the default setting of 'ON' each time the power is turned off.
- Use the User Memory function (page 63), to save the desired Local Control ON/OFF setting, allowing the current Local Control ON/OFF setting to remain even after the power is turned off.

16) MULTI-TIMBRAL MODE

This function allows the CN42 piano to receive data on more than one MIDI channel simultaneously. In this mode, the CN42 piano can play different musical parts with different sounds for each part.

This turns on the flexible 16 part Multi-Timbral capability. Individual MIDI channels can be turned ON and OFF, and assigned to any preset sound. The preset sound for each MIDI channel can be changed when the program change number for the desired sound is received from external MIDI device and instruments, or a personal computer. The CN42 piano's normal program change numbers are assigned in ON1 (corresponding to the program numbers listed in the left half of the chart on page 69 to 75), while General MIDI program change numbers are assigned in ON2 (corresponding to the program number and bank numbers listed in the right half of the chart in page 69 to 75). Please refer to page 61 for information regarding the Channel Mute function.

Multi-Timbral OFF

This turns off the Multi-Timbral capability. Only one MIDI channel will be active and only the sound currently selected will be heard when a MIDI signal is received.

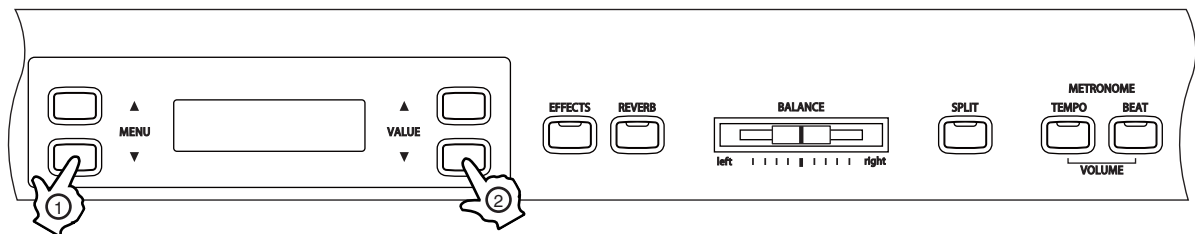

□ Step 1

Press the MENU buttons to select the Multi-Timbral Mode function.

```
16 Multi Timbre
= Off
```

OFF, ON1, or ON2 will be shown on the second line of the LCD display.

□ Step 2

Press the VALUE buttons to turn the set Multi-Timbral Mode to OFF, ON1, or ON2.

□ Step 3

Press any one of the SOUND SELECT buttons to exit the menu.

- The Multi-Timbral Mode function will return to the default setting of 'OFF' each time the power is turned off.
- Use the User Memory function (page 63), to save the desired Multi-Timbral Mode setting, allowing the current Multi-Timbral Mode setting to remain even after the power is turned off.
- When Multi-Timbral Mode is set to ON, sounds received via MIDI on the receive channels will all be played, even when split mode is active.

17) CHANNEL MUTE

This function determines which MIDI channels are activated to receive MIDI information when Multi-Timbral Mode is set to ON. Each of the 16 channels can be activated or deactivated individually.

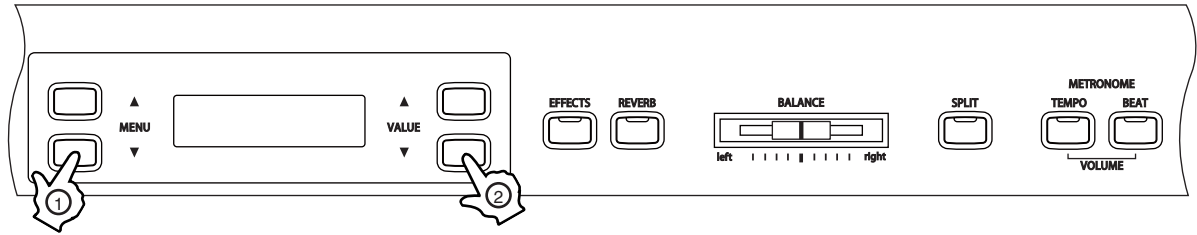

- Step 1
Press the MENU buttons to select the Channel Mute function.

The channel number and its Play/Mute status will be shown on the second line of the LCD display.

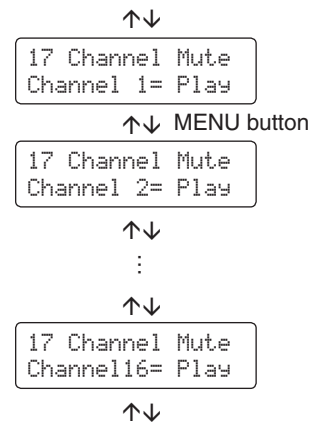

- Step 2
Press the VALUE buttons to set the Play/Mute status.

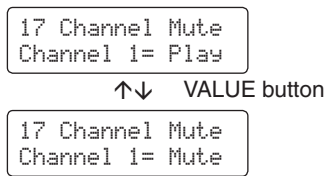

- Step 3
Press any one of the SOUND SELECT buttons to exit the menu.

- The Channel Mute function will return to the default settings of 'ON' each time the power is turned off.
- Use the User Memory function (page 63), to save the desired Channel Mute settings, allowing the current Channel Mute settings to remain even after the power is turned off.

18) SENDING PROGRAM CHANGE NUMBERS

This function allows the CN42 piano to send program change numbers within the range of 1 to 128.

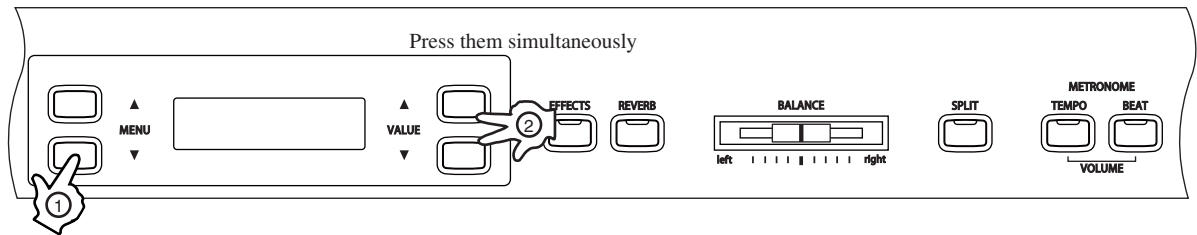

□ Step 1

Press the MENU buttons to select the Send Program Change Number function.

```
18 Send PGM #
= 1 (UP+DOWN)
```

The Program Change Number will be shown on the second line of the LCD display.

□ Step 2

Press the VALUE buttons to set the desired Program Change Number.

The value can be set within the range of 1 to 128.

□ Step 3

Press both VALUE buttons (▲▼) simultaneously to send the Program Change Number.

□ Step 4

Press any one of the SOUND SELECT buttons to exit the menu.

19) MIDI CLOCK

The MIDI Clock is the data code that MIDI instruments use as the reference for the tempo setting. When set to Internal, the CN42 piano uses its own built-in clock to control tempo settings. When set to External, the CN42 piano reads the clock data it receives via MIDI and uses this data to control the tempo.

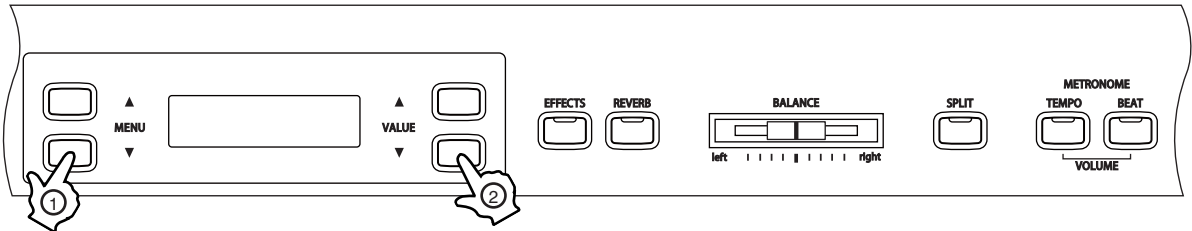

- Step 1
Press the MENU buttons to select the MIDI Clock function.

The selected MIDI Clock source will be shown on the second line of the LCD display.

- Step 2
Press the VALUE buttons to set the desired MIDI Clock setting.

```
19 MIDI Clock
= Int.
↑↓ VALUE button
```

- Step 3
Press any one of the SOUND SELECT buttons to exit the menu.

```
19 MIDI Clock
= Ext.
```

20) USER MEMORY

This function allows the CN42 piano to save user-definable settings which will be recalled every time the CN42 power is turned on.

The User Memory function can be used to store Effect settings, Metronome settings (tempo, time signature and volume), starting sound, primary sound for each sound category and the menu functions 1 through 16 described in the previous pages.

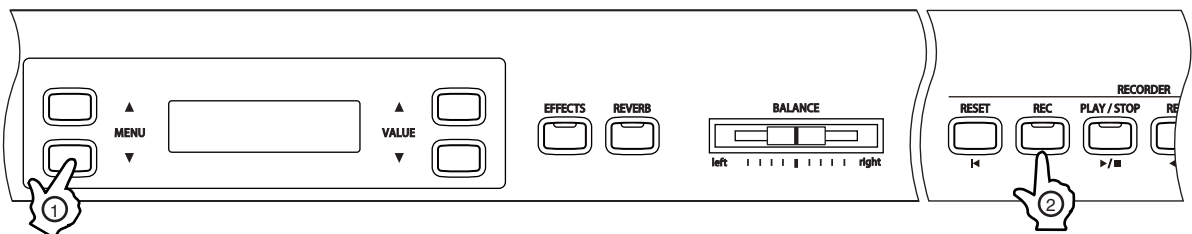

- Step 1
Press the MENU buttons to select the User Memory function.

```
20 User Memory
Save →Press REC
```

□ Step 2

Press the REC button to execute the save operation.



'Save Completed' be shown on the second line of the LCD display.

□ Step 3

Press any one of the SOUND SELECT buttons to exit the menu.

21) FACTORY RESET

This function will reset the CN42 piano to the default factory settings and is displayed only when the User Memory function has been used. All parameters saved in the User Memory will be reset to the factory preset values.

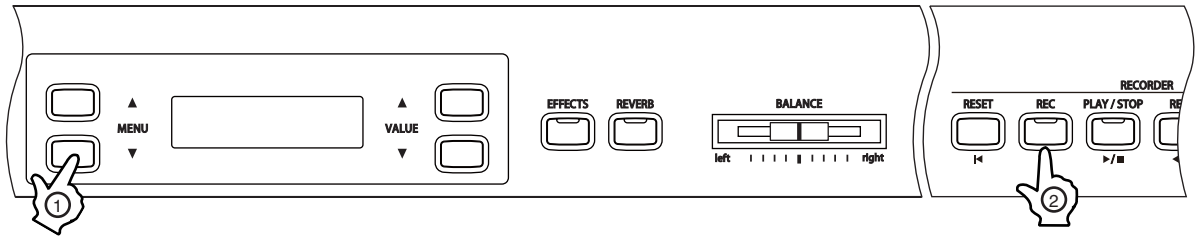

□ Step 1

Press the MENU buttons to select the Factory Reset function.

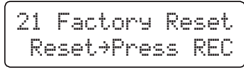

□ Step 2

Press the REC button to restore factory settings, and exit the menu.

7. APPENDICES

◇ CONNECTING TO OTHER DEVICES

⚠ Caution • Do not directly connect the LINE IN and LINE OUT jacks of the CN42 together with a cable. An audio loop (oscillation sound) will occur, resulting in damage to the unit.

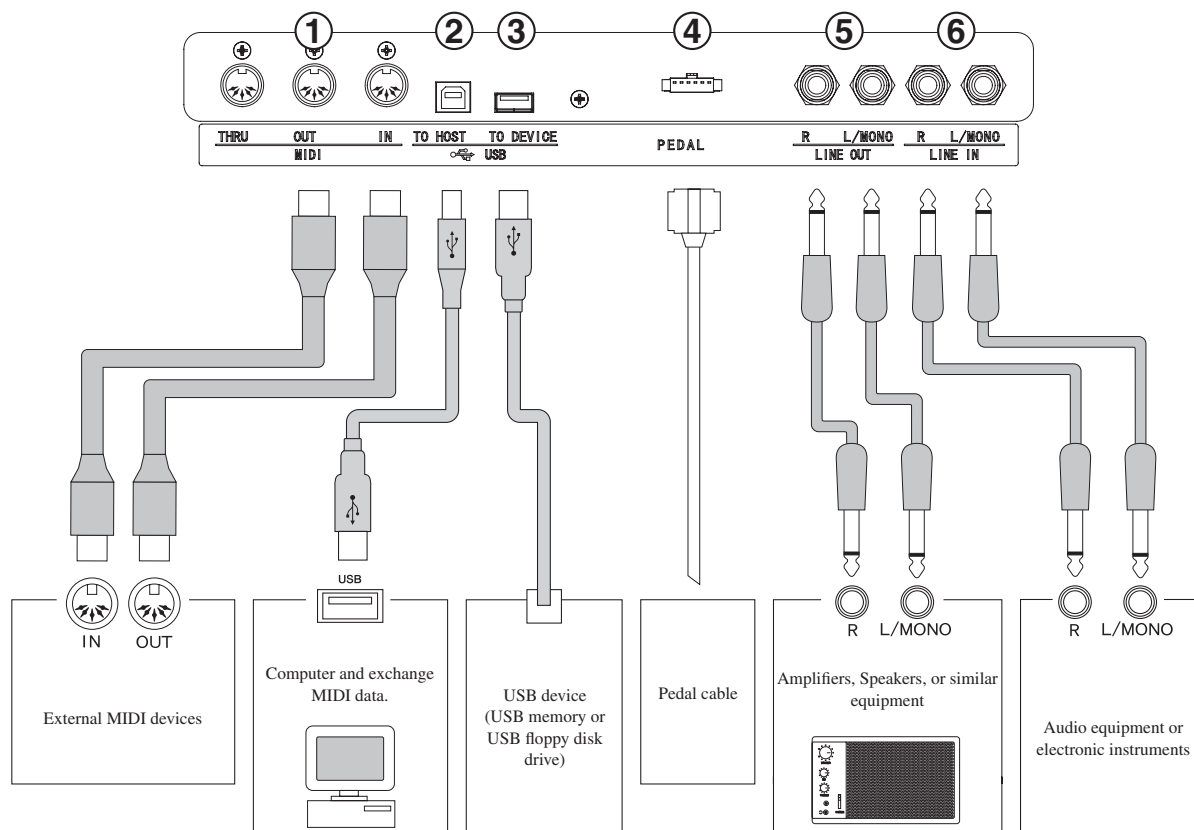

① MIDI JACKS

These jacks are used to connect external MIDI devices with the CN42 piano. There are three terminals: MIDI IN, MIDI OUT and MIDI THRU.

② USB to Host

This jack is used to connect with a personal computer and exchange MIDI data.

③ USB to Device

This jack is used to connect with a USB device. (USB memory or USB floppy disk drive)

④ PEDAL JACK

This jack is used to connect the pedal cord from the pedal board to the CN42 piano.

⑤ LINE OUT JACKS

These jacks provide stereo output of the CN42 piano's sound to amplifiers, tape recorders or similar equipment. The audio signal coming through the LINE IN jacks is also routed to these jacks. The CN42 piano's sound is mixed with the LINE IN signals.

The CN42 piano's VOLUME slider controls the output level of its own sound without affecting the level of the LINE IN signal.

⑥ LINE IN JACKS

These jacks are used to connect a pair of stereo outputs from other audio equipment or electronic instruments to the CN42 piano's speakers. The audio signal coming through these jacks bypasses the CN42 piano's volume control. To adjust the volume level, use the output control of the external device.

ABOUT A USB DRIVER

For data exchange between a computer and digital piano via USB connection, software (USB-MIDI driver) must be installed on the computer for proper digital piano operations.

Please read the following instructions carefully as a different USB-MIDI driver may be necessary depending on the computer OS.

◇ Windows XP / Me users:

The standard USB-MIDI driver installed on Windows will be used. This USB-MIDI driver will be automatically installed when the unit is connected to the computer.

To establish MIDI communications with the unit by using an application, select "USB audio device" to define the unit as a MIDI device.

◇ Windows Vista / 2000 / 98SE users:

You need to install the specified, special USB-MIDI driver. Download the special USB driver from the KAWAI site as shown below, and install it on the computer.

http://www.kawaius.com/archive/download_archive_2.html

Read the instruction manual thoroughly before connecting the unit to the computer, and make sure to install the driver.

If you connect the unit to the computer without installing the driver, the USB-MIDI driver may not operate properly. If this occurs, use the driver update function of the OS to install the appropriate USB-MIDI driver, or delete the driver by using the driver delete function and then install the driver again.

To establish MIDI communications with the unit by using an application, select "KAWAI USB MIDI IN" and "KAWAI USB MIDI OUT" to define the unit as a MIDI device.

◇ Macintosh OS X users:

When the unit is used with Macintosh OS X, the unit will be recognized as a MIDI device automatically; therefore, no special driver is needed.

To establish MIDI communications with the unit by using an application, select "USB-MIDI" to define the unit as a MIDI device.

◇ Users of Macintosh OS9 or earlier:

The unit does not support Macintosh OS9 or earlier. Please establish a MIDI connection by using a commercially available MIDI interface.

NOTES ON USB

- When MIDI and USB are connected simultaneously, USB will be prioritized.
 - When connecting a digital piano to a computer by using a USB cable, first connect the cable and then turn on the power of the digital piano.
 - When a digital piano is connected to a computer by using a USB cable, it may take some time before communications start.
 - When a digital piano and a computer are connected via a hub, and the operation is not stable, connect the digital piano directly to the USB port of the computer.
 - Operations of a computer or a digital piano may become unstable if the power of the piano is turned on or off, or if the USB cable is pulled out or inserted during:
 - * Driver installation
 - * Computer power-up
 - * MIDI application operations
 - * Communication with the computer
 - * Standby in power-saving mode
- * USB may not operate properly depending on the settings of your computer. Read the computer instruction manual thoroughly before use and ensure that appropriate settings are made.

* "MIDI" is a registered trademark of the Association of Manufacturers of Electronic Instruments (AMEI).

* Windows is a registered trademark of Microsoft Corporation.

* Macintosh is a registered trademark of Apple Computer, Inc.

* Other company names and product names mentioned referenced herein may be registered trademarks or trademarks of respective owners.

◇ ASSEMBLY INSTRUCTIONS

- ⚠ Caution**
- Ensure that this instruction manual is read thoroughly before attempting to assemble the CN42 piano, and that two or more people work on assembly.
 - It may be necessary to tilt the unit by 90 degrees while assembling the CN42 piano. During this time, ensure that hands are not caught in the piano, keyboard lid, or score stand, and that the piano is not dropped on an individual's feet.

■ PARTS PROVIDED

Before attempting to assemble the CN42 piano unit, ensure that all parts are included. A Phillips-head screwdriver will also be required to assemble the unit (not included).

- (A) Piano (x 1)
- (B) Pedal board (x 1)
- (C) End panel (x 1 each for left and right)
- (D) Back panel (x 1)
- (E) Adjuster bolt (x 1)
- (F) Screw: $\phi 4 \times 16$ (x 4) (Silver)
- (G) Screw: $\phi 4 \times 20$ (x 4)
- (H) Screw: $\phi 4 \times 30$ (x 4)
- (I) Screw: M6 x 25 (x 4)
- (J) Cord clamp (x 2)
- (K) Headphone hook and screws (x 1 set)
- (L) Power cord (x 1)

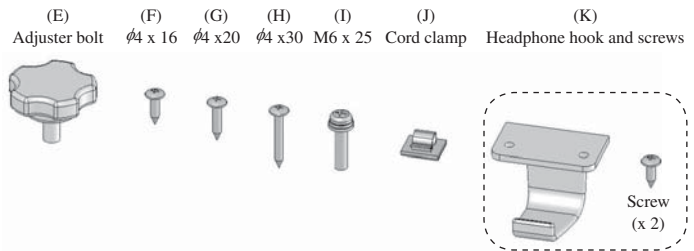

■ ASSEMBLY SEQUENCE

- ⚠ Caution**
- Be careful not to scratch or damage the floor, piano, or stand at the time of assembly.

1. Screw the adjuster bolt (E) into the threaded screw hole provided on the pedal.
2. From the side of the screw that is already on the backside of the pedal board (B), slide and insert the bracket of the end panel (C).
3. While pressing the end panel (C) against the pedal board (B), tighten the already-provided screws, one each on the left and right sides, and then tighten two screws (F) on each side.
4. Untie and pull out the pedal cable.
5. Set the back panel (D) and tighten the screws (G) (H) into the prepared holes. Loosely tighten the screws with the * symbol.

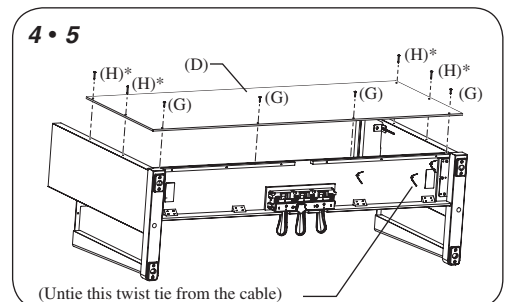
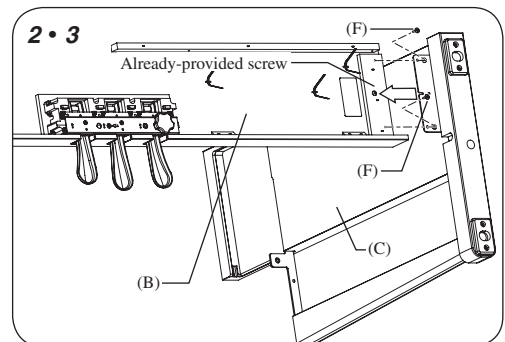
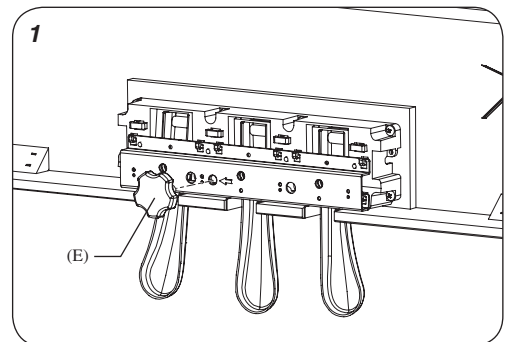

6. Place the stand so that the backside of the stand assembly rests against a wall, and then slowly and carefully insert the piano. Ensure that more than two people work on the assembly. If attempting to insert the piano without resting the stand against a wall, support the back of the stand using your foot or leg to prevent the stand from sliding backwards.

Caution • Ensure that the piano is not dropped on an individual's feet, and that fingers, hands and feet are not caught in the piano.

7. Press the end panel (C) of the stand to the piano (A), and then fasten the piano (A) to the stand with four screws (I).

Caution • Ensure that the piano and the stand are securely fastened together with the screws, preventing the possibility of the piano falling.

8. Fix the headphone hook and screws (K).
*If the headphone hook will not be required, it can be kept with the instruction manual.

9. Tightly fasten the loosely fastened screws (H) with the * symbol.

10. Insert the connector of the pedal cord into the receptacle, and fix the cord with the cord clamp (J) (make sure that the protrusion of the connector is facing the correct direction, and insert the connector straight).

11. Turn the adjuster bolt (E) at the bottom of the pedal stand until the bolt firmly touches the floor and supports the pedal board.

Caution • Ensure that the adjuster bolt (E) firmly touches the floor, supporting the pedal board and preventing damage. When moving the piano, remove the adjuster bolt (E) and readjust after moving has been completed.

12. Insert the power cord (L) into the piano.

13. Remove the protective film from the display.

Assembly is now complete.

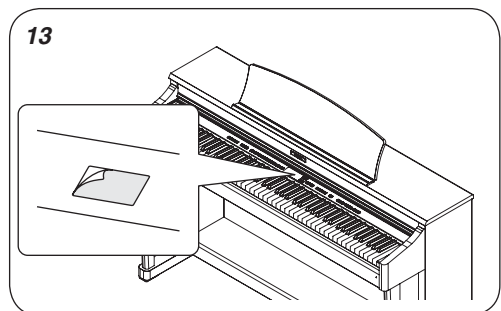
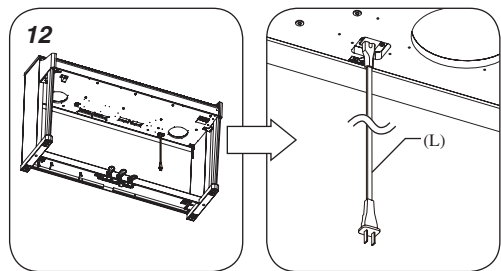
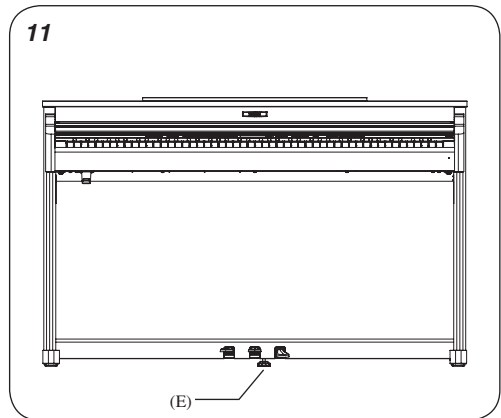
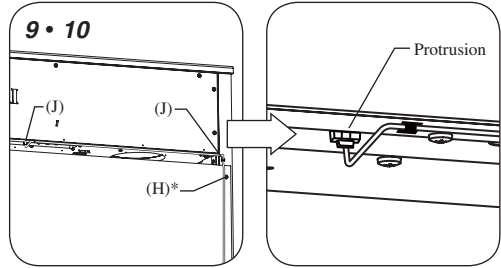
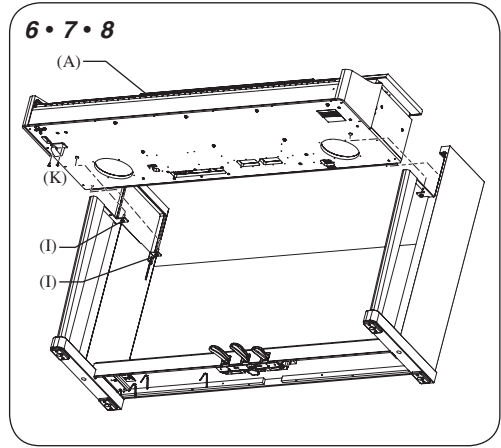

◇ PROGRAM CHANGE NUMBER MAPPING

Category	Sound	Multi-Timbral mode				
		Off, On 1		On 2		
		Bank LSB	Prog #	Bank MSB	Bank LSB	Prog #
PIANO1	Concert Grand	0	1	121	0	1
	Studio Grand	0	2	121	1	1
	Mellow Grand	0	3	121	2	1
	Modern Piano	0	4	121	0	2
PIANO2	Concert Grand 2	0	5	95	16	1
	Studio Grand 2	0	6	95	17	1
	Mellow Grand 2	0	7	95	18	1
	Rock Piano	0	8	121	1	2
ELECTRIC PIANO	Classic E.P.	0	9	121	0	5
	Modern E.P.	0	10	121	0	6
	60's E.P.	0	11	121	3	5
	Modern E.P. 2	0	12	121	1	6
DRAWBAR	Jazz Organ	0	13	121	0	18
	Drawbar Organ	0	14	121	0	17
	Drawbar Organ 2	0	15	121	1	17
	Be 3	0	16	95	2	17
CHURCH ORGAN	Church Organ	0	17	121	0	20
	Diapason	0	18	95	7	20
	Full Ensemble	0	19	95	1	21
	Diapason Oct.	0	20	95	6	20
HARPSI&MALLETS	Harpsichord	0	21	121	0	7
	Harpsichord 2	0	22	121	3	7
	Vibraphone	0	23	121	0	12
	Clavi	0	24	121	0	8
STRINGS	Slow Strings	0	25	95	1	45
	String Pad	0	26	95	8	49
	Warm Strings	0	27	95	1	49
	String Ensemble	0	28	121	0	49
CHOIR&PAD	Choir	0	29	121	0	53
	Choir 2	0	30	95	53	54
	New Age	0	31	121	0	89
	Atmosphere	0	32	121	0	100
BASS	Wood Bass	0	33	121	0	33
	Electric Bass	0	34	121	0	34
	Fretless Bass	0	35	121	0	36
	W. Bass & Ride	0	36	95	1	33
OTHERS : PIANO	Jazz Grand	0	37	95	8	1
	New Age Piano	0	38	95	9	1
	New Age Piano 2	0	39	95	10	1
	New Age Piano 3	0	40	95	11	1
	Piano Octaves	0	41	95	1	1
	Electric Grand	0	42	121	0	3
	Electric Grand2	0	43	121	1	3
	Honky Tonk	0	44	121	0	4
	Wide Honky Tonk	0	45	121	1	4

Category	Sound	Multi-Timbral mode				
		Off, On 1		On 2		
		Bank LSB	Prog #	Bank MSB	Bank LSB	Prog #
OTHERS : E.PIANO	Dolce E.P.	0	46	95	2	5
	Crystal E.P.	0	47	95	1	6
	Tremolo E.P.	0	48	95	1	5
	Classic E.P. 2	0	49	121	1	5
	Classic E.P. 3	0	50	121	2	5
	New Age E.P.	0	51	95	2	6
	Modern E.P. 3	0	52	121	2	6
	Legend E.P.	0	53	121	3	6
	Phase E.P.	0	54	121	4	6
OTHERS : HARPSI&MALLET	Harpsichord Oct	0	55	121	1	7
	WideHarpsichord	0	56	121	2	7
	Synth Clavi	0	57	121	1	8
	Celesta	0	58	121	0	9
	Glockenspiel	0	59	121	0	10
	Music Box	0	60	121	0	11
	Wide Vibraphone	0	61	121	1	12
	Marimba	0	62	121	0	13
	Wide Marimba	0	63	121	1	13
	Xylophone	0	64	121	0	14
	Handbells	0	65	95	1	15
	Tubular Bells	0	66	121	0	15
	Church Bells	0	67	121	1	15
	Carillon	0	68	121	2	15
Dulcimer	0	69	121	0	16	
OTHERS : DRAWBAR	Soft Solo	0	70	95	8	17
	Drawbar Organ 3	0	71	95	1	17
	Jazzer	0	72	95	1	18
	Hi-Lo	0	73	95	3	17
	Drawbar Organ 4	0	74	121	3	17
	ElectronicOrgan	0	75	95	9	17
	60's Organ	0	76	121	2	17
	Perc. Organ	0	77	121	1	18
	Perc. Organ 2	0	78	121	2	18
	Tibia Bass	0	79	95	14	18
	Rock Organ	0	80	121	0	19
OTHERS : CHURCH ORGAN	Principal Oct.	0	81	95	24	20
	Theater Organ	0	82	95	1	20
	8' Celeste	0	83	95	5	20
	Small Ensemble	0	84	95	8	20
	Reeds	0	85	95	10	20
	Chiffy Tibia	0	86	95	17	20
	Principal Pipe	0	87	95	22	20
	Church Organ 2	0	88	121	1	20
	Church Organ 3	0	89	121	2	20
	Reed Organ	0	90	121	0	21
	Puff Organ	0	91	121	1	21

Category	Sound	Multi-Timbral mode					
		Off, On 1		On 2			
		Bank LSB	Prog #	Bank MSB	Bank LSB	Prog #	
OTHERS : ACCORDION	FrenchAccordion	0	92	121	0	22	
	Fr. Accordion 2	0	93	95	1	22	
	Accordion	0	94	121	1	22	
	Accordion 2	0	95	95	2	22	
	Blues Harmonica	0	96	95	2	23	
	Harmonica	0	97	121	0	23	
	Tango Accordion	0	98	121	0	24	
OTHERS : GUITAR	FingerNylon Gtr	0	99	95	4	25	
	Nylon Acoustic	0	100	121	0	25	
	Nylon Acoustic2	0	101	121	2	25	
	Nylon Acoustic3	0	102	121	3	25	
	Ukulele	0	103	121	1	25	
	Steel Guitar	0	104	121	0	26	
	Steel Guitar 2	0	105	121	3	26	
	12 String	0	106	121	1	26	
	Mandolin	0	107	121	2	26	
	Jazz Guitar	0	108	121	0	27	
	Pedal Steel	0	109	121	1	27	
	Rhythm Guitar	0	110	121	2	28	
	Electric Guitar	0	111	121	0	28	
	E. Guitar 2	0	112	121	1	28	
	E. Guitar 3	0	113	121	2	29	
	Muted Electric	0	114	121	0	29	
	Cutting Guitar	0	115	121	1	29	
	Country Lead	0	116	121	3	29	
	OverdriveGuitar	0	117	121	0	30	
	Dynmic Ov.drive	0	118	121	1	30	
	Distortion	0	119	121	0	31	
	Dist Feedback	0	120	121	1	31	
	Dist Rhythm	0	121	121	2	31	
	E.Gtr Harmonics	0	122	121	0	32	
	Guitar Feedback	0	123	121	1	32	
	OTHERS : BASS	Wood Bass 2	0	124	95	5	33
		FingerSlap Bass	0	125	121	1	34
Pick Bass		0	126	121	0	35	
Slap Bass		0	127	121	0	37	
Slap Bass 2		0	128	121	0	38	
Synth Bass		1	1	121	0	39	
Synth Bass 2		1	2	121	0	40	
Synth Bass 3		1	3	121	2	39	
Synth Bass 4		1	4	121	1	40	
Warm Synth Bass		1	5	121	1	39	
Clavi Bass		1	6	121	3	39	
Hammer Bass		1	7	121	4	39	
Rubber Bass		1	8	121	2	40	
Attack Bass	1	9	121	3	40		

Category	Sound	Multi-Timbral mode				
		Off, On 1		On 2		
		Bank LSB	Prog #	Bank MSB	Bank LSB	Prog #
OTHERS : STRINGS&ORCHINST	Violin	1	10	121	0	41
	Slow Violin	1	11	121	1	41
	Viola	1	12	121	0	42
	Cello	1	13	121	0	43
	Contrabass	1	14	121	0	44
	Tremolo Strings	1	15	121	0	45
	Strings & Brass	1	16	121	1	49
	60's Strings	1	17	121	2	49
	StringEnsemble2	1	18	121	0	50
	Synth Strings	1	19	121	0	51
	Synth Strings 3	1	20	121	1	51
	Synth Strings 2	1	21	121	0	52
	Pizzicato	1	22	121	0	46
	Harp	1	23	121	0	47
	Celtic Harp	1	24	121	1	47
	Timpani	1	25	121	0	48
OTHERS : CHOIR&HIT	Choir 3	1	26	121	1	53
	Voice Oohs	1	27	121	0	54
	Humming	1	28	121	1	54
	Synth Vocal	1	29	121	0	55
	Analog Voice	1	30	121	1	55
	Orchestra Hit	1	31	121	0	56
	Bass Hit Plus	1	32	121	1	56
	6th Hit	1	33	121	2	56
	Euro Hit	1	34	121	3	56
OTHERS : BRASS	Trumpet	1	35	121	0	57
	Solo Trumpet	1	36	121	1	57
	Flugel Horn	1	37	95	1	57
	SentimentalBone	1	38	95	7	58
	Trombone	1	39	121	0	58
	Trombone 2	1	40	121	1	58
	Bright Trombone	1	41	121	2	58
	Tuba	1	42	121	0	59
	CupMute Trumpet	1	43	95	1	60
	CupMuteTrombone	1	44	95	2	60
	Muted Trumpet	1	45	121	0	60
	Muted Trumpet 2	1	46	121	1	60
	French Horns	1	47	121	0	61
	Warm FrenchHorn	1	48	121	1	61
	Brass Section	1	49	121	0	62
	Brass Section 2	1	50	121	1	62
	Synth Brass	1	51	121	0	63
	Synth Brass 3	1	52	121	1	63
	Synth Brass 2	1	53	121	0	64
	Synth Brass 4	1	54	121	1	64
Jump Brass	1	55	121	3	63	
Analog Brass	1	56	121	2	63	
Analog Brass 2	1	57	121	2	64	

Category	Sound	Multi-Timbral mode				
		Off, On 1		On 2		
		Bank LSB	Prog #	Bank MSB	Bank LSB	Prog #
OTHERS : REED	Oboe & Strings	1	58	95	5	69
	Soprano Sax	1	59	121	0	65
	Alto Sax	1	60	121	0	66
	Soft Tenor Sax	1	61	95	2	67
	Tenor Sax	1	62	121	0	67
	Baritone Sax	1	63	121	0	68
	Oboe	1	64	121	0	69
	English Horn	1	65	121	0	70
	Bassoon	1	66	121	0	71
	Clarinet	1	67	121	0	72
OTHERS : PIPE	Flute & Strings	1	68	95	8	74
	Piccolo	1	69	121	0	73
	Jazz Flute	1	70	95	1	74
	Big Band Winds	1	71	95	2	74
	OrchestralWinds	1	72	95	3	74
	Flute	1	73	121	0	74
	Ballad Flute	1	74	95	13	74
	Recorder	1	75	121	0	75
	Pan Flute	1	76	121	0	76
	Blown Bottle	1	77	121	0	77
	Shakuhachi	1	78	121	0	78
	Whistle	1	79	121	0	79
	Ocarina	1	80	121	0	80
OTHERS : SYNTH LEAD	Square	1	81	121	0	81
	Square 2	1	82	121	1	81
	Sine	1	83	121	2	81
	Classic Synth	1	84	121	0	82
	Classic Synth 2	1	85	121	1	82
	Lead	1	86	121	2	82
	Classic Synth 3	1	87	121	3	82
	SequencedAnalog	1	88	121	4	82
	Caliope	1	89	121	0	83
	Chiff	1	90	121	0	84
	Charang	1	91	121	0	85
	Wire Lead	1	92	121	1	85
	Voice	1	93	121	0	86
	Fifth	1	94	121	0	87
	Bass & Lead	1	95	121	0	88
Soft Wire Lead	1	96	121	1	88	
OTHERS : SYNTH PAD	Itopia	1	97	121	1	92
	New Age 2	1	98	95	1	89
	New Age 3	1	99	95	2	89
	New Age 4	1	100	95	3	89
	Warm Pad	1	101	121	0	90
	Sine Pad	1	102	121	1	90
	Polysynth	1	103	121	0	91
Choir	1	104	121	0	92	

Category	Sound	Multi-Timbral mode				
		Off, On 1		On 2		
		Bank LSB	Prog #	Bank MSB	Bank LSB	Prog #
OTHERS : SYNTH PAD	Bowed	1	105	121	0	93
	Metallic	1	106	121	0	94
	Halo	1	107	121	0	95
	Sweep	1	108	121	0	96
OTHERS : SYNTH SFX	Rain Pad	1	109	121	0	97
	Soundtrack	1	110	121	0	98
	Crystal	1	111	121	0	99
	Synth Mallet	1	112	121	1	99
	Brightness	1	113	121	0	101
	Goblin	1	114	121	0	102
	Echoes	1	115	121	0	103
	Echo Bell	1	116	121	1	103
	Echo Pan	1	117	121	2	103
	Sci-Fi	1	118	121	0	104
OTHERS : ETHNIC	Sitar	1	119	121	0	105
	Sitar 2	1	120	121	1	105
	Banjo	1	121	121	0	106
	Shamisen	1	122	121	0	107
	Koto	1	123	121	0	108
	Taisho Koto	1	124	121	1	108
	Kalimba	1	125	121	0	109
	Bag Pipe	1	126	121	0	110
	Fiddle	1	127	121	0	111
Shanai	1	128	121	0	112	
OTHERS : PERCUSSION	Tinkle Bell	2	1	121	0	113
	Agogo	2	2	121	0	114
	Steel Drums	2	3	121	0	115
	Woodblock	2	4	121	0	116
	Castanet	2	5	121	1	116
	Taiko Drums	2	6	121	0	117
	Concert BD	2	7	121	1	117
	Melodic Toms	2	8	121	0	118
	Melodic Toms 2	2	9	121	1	118
	Synth Drum	2	10	121	0	119
	Rhythm Box Tom	2	11	121	1	119
	Electric Drum	2	12	121	2	119
	Reverse Cymbal	2	13	121	0	120
	Gtr Fret Noise	2	14	121	0	121
	GtrCuttingNoise	2	15	121	1	121
Ac Bass Slap	2	16	121	2	121	
OTHERS : SFX	Breath Noise	2	17	121	0	122
	Flute Key Click	2	18	121	1	122
	Seashore	2	19	121	0	123
	Rain	2	20	121	1	123
	Thunder	2	21	121	2	123
	Wind	2	22	121	3	123
	Stream	2	23	121	4	123
	Bubble	2	24	121	5	123

Category	Sound	Multi-Timbral mode				
		Off, On 1		On 2		
		Bank LSB	Prog #	Bank MSB	Bank LSB	Prog #
OTHERS : SFX	Bird Tweet	2	25	121	0	124
	Dog Barking	2	26	121	1	124
	Horse Gallop	2	27	121	2	124
	Bird Tweet 2	2	28	121	3	124
	Telephone	2	29	121	0	125
	Telephone 2	2	30	121	1	125
	Door Creak	2	31	121	2	125
	Door Slam	2	32	121	3	125
	Scratch	2	33	121	4	125
	Wind Chime	2	34	121	5	125
	Helicopter	2	35	121	0	126
	Car Engine	2	36	121	1	126
	Car Stopping	2	37	121	2	126
	Car Passing	2	38	121	3	126
	Car Crash	2	39	121	4	126
	Siren	2	40	121	5	126
	Train	2	41	121	6	126
	Jet Plane	2	42	121	7	126
	Starship	2	43	121	8	126
	Burst Noise	2	44	121	9	126
	Applause	2	45	121	0	127
	Laughing	2	46	121	1	127
	Screaming	2	47	121	2	127
	Punch	2	48	121	3	127
	Heartbeat	2	49	121	4	127
	Foot Step	2	50	121	5	127
	Gunshot	2	51	121	0	128
	Machine Gun	2	52	121	1	128
	Laser Gun	2	53	121	2	128
	Explosion	2	54	121	3	128
OTHERS : DRUMKIT	Standard Set	2	55	120	0	1
	Room Set	2	56	120	0	9
	Power Set	2	57	120	0	17
	Electronic Set	2	58	120	0	25
	Analog Set	2	59	120	0	26
	Jazz Set	2	60	120	0	33
	Brush Set	2	61	120	0	41
	Orchestra Set	2	62	120	0	49
	SFX Set	2	63	120	0	57

◇ DRUM SOUND MAPPING

	Standard Set	Room Set	Power Set	Electronic Set	Analog Set
	D# High Q	High Q	High Q	High Q	High Q
	E Slap	Slap	Slap	Slap	Slap
	F Scratch Push	Scratch Push	Scratch Push	Scratch Push	Scratch Push
	F# Scratch Pull	Scratch Pull	Scratch Pull	Scratch Pull	Scratch Pull
	G Sticks	Sticks	Sticks	Sticks	Sticks
	G# Square Click	Square Click	Square Click	Square Click	Square Click
	A Metronome Click	Metronome Click	Metronome Click	Metronome Click	Metronome Click
	A# Metronome Bell	Metronome Bell	Metronome Bell	Metronome Bell	Metronome Bell
	B Acoustic Bass Drum	Acoustic Bass Drum	Acoustic Bass Drum	Acoustic Bass Drum	Acoustic Bass Drum
C2	C Bass Drum 1	Bass Drum 1	Power Kick Drum	Electric Bass Drum	Analog Bass Drum
	C# Side Stick	Side Stick	Side Stick	Side Stick	Analog Rim Shot
	D Acoustic Snare	Acoustic Snare	Power Snare Drum	Electric Snare 1	Analog Snare 1
	D# Hand Clap	Hand Clap	Hand Clap	Hand Clap	Hand Clap
	E Electric Snare	Electric Snare	Electric Snare	Electric Snare 2	Electric Snare
	F Low Floor Tom	Room Low Tom 2	Power Low Tom 2	Electric Low Tom 2	Analog Low Tom 2
	F# Closed Hi-hat	Closed Hi-hat	Closed Hi-hat	Closed Hi-hat	Analog CHH 1
	G High Floor Tom	Room Low Tom 1	Power Low Tom 1	Electric Low Tom 1	Analog Low Tom 1
	G# Pedal Hi-hat	Pedal Hi-hat	Pedal Hi-hat	Pedal Hi-hat	Analog CHH 2
	A Low Tom	Room Mid Tom 2	Power Mid Tom 2	Electric Mid Tom 2	Analog Mid Tom 2
	A# Open Hi-hat	Open Hi-hat	Open Hi-hat	Open Hi-hat	Analog OHH
	B Low-Mid Tom	Room Mid Tom 1	Power Mid Tom 1	Electric Mid Tom 1	Analog Mid Tom 1
C3	C High-Mid Tom	Room Hi Tom 2	Power Hi Tom 2	Electric Hi Tom 2	Analog Hi Tom 2
	C# Crash Cymbal 1	Crash Cymbal 1	Crash Cymbal 1	Crash Cymbal 1	Analog Cymbal
	D Hi Tom	Room Hi Tom 1	Power Hi Tom 1	Electric Hi Tom 1	Analog Hi Tom 1
	D# Ride Cymbal 1	Ride Cymbal 1	Ride Cymbal 1	Ride Cymbal 1	Ride Cymbal 1
	E Chinese Cymbal	Chinese Cymbal	Chinese Cymbal	Reverse Cymbal	Chinese Cymbal
	F Ride Bell	Ride Bell	Ride Bell	Ride Bell	Ride Bell
	F# Tambourine	Tambourine	Tambourine	Tambourine	Tambourine
	G Splash Cymbal	Splash Cymbal	Splash Cymbal	Splash Cymbal	Splash Cymbal
	G# Cowbell	Cowbell	Cowbell	Cowbell	Analog Cowbell
	A Crash Cymbal 2	Crash Cymbal 2	Crash Cymbal 2	Crash Cymbal 2	Crash Cymbal 2
	A# Vibra-slap	Vibra-slap	Vibra-slap	Vibra-slap	Vibra-slap
	B Ride Cymbal 2	Ride Cymbal 2	Ride Cymbal 2	Ride Cymbal 2	Ride Cymbal 2
C4	C High Bongo	High Bongo	High Bongo	High Bongo	High Bongo
	C# Low Bongo	Low Bongo	Low Bongo	Low Bongo	Low Bongo
	D Mute Hi Conga	Mute Hi Conga	Mute Hi Conga	Mute Hi Conga	Analog Hi Conga
	D# Open Hi Conga	Open Hi Conga	Open Hi Conga	Analog Mid Conga	Analog Mid Conga
	E Low Conga	Low Conga	Low Conga	Analog Low Conga	Analog Low Conga
	F High Timbale	High Timbale	High Timbale	High Timbale	High Timbale
	F# Low Timbale	Low Timbale	Low Timbale	Low Timbale	Low Timbale
	G High Agogo	High Agogo	High Agogo	High Agogo	High Agogo
	G# Low Agogo	Low Agogo	Low Agogo	Low Agogo	Low Agogo
	A Cabasa	Cabasa	Cabasa	Cabasa	Cabasa
	A# Maracas	Maracas	Maracas	Maracas	Analog Maracas
	B Short Whistle	Short Whistle	Short Whistle	Short Whistle	Short Whistle
C5	C Long Whistle	Long Whistle	Long Whistle	Long Whistle	Long Whistle
	C# Short Guiro	Short Guiro	Short Guiro	Short Guiro	Short Guiro
	D Long Guiro	Long Guiro	Long Guiro	Long Guiro	Long Guiro
	D# Claves	Claves	Claves	Claves	Analog Claves
	E Hi Wood Block	Hi Wood Block	Hi Wood Block	Hi Wood Block	Hi Wood Block
	F Low Wood Block	Low Wood Block	Low Wood Block	Low Wood Block	Low Wood Block
	F# Mute Cuica	Mute Cuica	Mute Cuica	Mute Cuica	Mute Cuica
	G Open Cuica	Open Cuica	Open Cuica	Open Cuica	Open Cuica
	G# Mute Triangle	Mute Triangle	Mute Triangle	Mute Triangle	Mute Triangle
	A Open Triangle	Open Triangle	Open Triangle	Open Triangle	Open Triangle
	A# Shaker	Shaker	Shaker	Shaker	Shaker
	B Jingle Bell	Jingle Bell	Jingle Bell	Jingle Bell	Jingle Bell
C6	C Bell Tree	Bar Chimes	Bar Chimes	Bar Chimes	Bar Chimes
	C# Castanets	Castanets	Castanets	Castanets	Castanets
	D Mute Surdo	Mute Surdo	Mute Surdo	Mute Surdo	Mute Surdo
	D# Open Surdo	Open Surdo	Open Surdo	Open Surdo	Open Surdo
	E				

	Jazz Set	Brush Set	Orchestra Set	SFX Set
	D# High Q	High Q	Closed Hi-hat 2	
	E Slap	Slap	Pedal Hi-hat	
	F Scratch Push	Scratch Push	Open Hi-hat 2	
	F# Scratch Pull	Scratch Pull	Ride Cymbal 1	
	G Sticks	Sticks	Sticks	
	G# Square Click	Square Click	Square Click	
	A Metronome Click	Metronome Click	Metronome Click	
	A# Metronome Bell	Metronome Bell	Metronome Bell	
	B Jazz Kick 2	Jazz Kick 2	Concert BD 2	
C2	C Jazz Kick 1	Jazz Kick 1	Concert BD 1	
	C# Side Stick	Side Stick	Side Stick	
	D Acoustic Snare	Brush Tap	Concert SD	
	D# Hand Clap	Brush Slap	Castanets	High Q
	E Electric Snare	Brush Swirl	Concert SD	Slap
	F Low Floor Tom	Low Floor Tom	Timpani F	Scratch Push
	F# Closed Hi-hat	Closed Hi-hat	Timpani F#	Scratch Pull
	G High Floor Tom	High Floor Tom	Timpani G	Sticks
	G# Pedal Hi-hat	Pedal Hi-hat	Timpani G#	Square Click
	A Low Tom	Low Tom	Timpani A	Metronome Click
	A# Open Hi-hat	Open Hi-hat	Timpani A#	Metronome Bell
	B Low-Mid Tom	Low-Mid Tom	Timpani B	Guitar Fret Noise
C3	C High-Mid Tom	High-Mid Tom	Timpani c	Guitar Cutting Noise Up
	C# Crash Cymbal 1	Crash Cymbal 1	Timpani c#	Guitar Cutting Noise Down
	D Hi Tom	Hi Tom	Timpani d	String Slap of Double Bass
	D# Ride Cymbal 1	Ride Cymbal 1	Timpani d#	Fl. Key Click
	E Chinese Cymbal	Chinese Cymbal	Timpani e	Laughing
	F Ride Bell	Ride Bell	Timpani f	Scream
	F# Tambourine	Tambourine	Tambourine	Punch
	G Splash Cymbal	Splash Cymbal	Splash Cymbal	Heart Beat
	G# Cowbell	Cowbell	Cowbell	Footsteps 1
	A Crash Cymbal 2	Crash Cymbal 2	Concert Cymbal 2	Footsteps 2
	A# Vibra-slap	Vibra-slap	Vibra-slap	Applause
	B Ride Cymbal 2	Ride Cymbal 2	Concert Cymbal 1	Door Creaking
C4	C High Bongo	High Bongo	High Bongo	Door
	C# Low Bongo	Low Bongo	Low Bongo	Scratch
	D Mute Hi Conga	Mute Hi Conga	Mute Hi Conga	Wind Chimes
	D# Open Hi Conga	Open Hi Conga	Open Hi Conga	Car-Engine
	E Low Conga	Low Conga	Low Conga	Car-Stop
	F High Timbale	High Timbale	High Timbale	Car-Pass
	F# Low Timbale	Low Timbale	Low Timbale	Car-Crash
	G High Agogo	High Agogo	High Agogo	Siren
	G# Low Agogo	Low Agogo	Low Agogo	Train
	A Cabasa	Cabasa	Cabasa	Jetplane
	A# Maracas	Maracas	Maracas	Helicopter
	B Short Whistle	Short Whistle	Short Whistle	Startship
C5	C Long Whistle	Long Whistle	Long Whistle	Gun Shot
	C# Short Guiro	Short Guiro Short Guiro	Machine Gun	
	D Long Guiro	Long Guiro	Long Guiro	Lasergun
	D# Claves	Claves	Claves	Explosion
	E Hi Wood Block	Hi Wood Block	Hi Wood Block	Dog
	F Low Wood Block	Low Wood Block	Low Wood Block	Horse-Gallop
	F# Mute Cuica	Mute Cuica	Mute Cuica	Birds
	G Open Cuica	Open Cuica	Open Cuica	Rain
	G# Mute Triangle	Mute Triangle	Mute Triangle	Thunder
	A Open Triangle	Open Triangle	Open Triangle	Wind
	A# Shaker	Shaker	Shaker	Seashore
	B Jingle Bell	Jingle Bell	Jingle Bell	Stream
C6	C Bell Tree	Bar Chimes	Bar Chimes	Bubble
	C# Castanets	Castanets	Castanets	
	D Mute Surdo	Mute Surdo	Mute Surdo	
	D# Open Surdo	Open Surdo	Open Surdo	
	E Applause			

◇ SPECIFICATIONS

■ Keyboard	88 Weighted Keyboard with Advanced Hammer Action IV-F
■ Polyphony	Maximum 192
■ Number of Sound	310 + 9 Drum Set
■ Sound Categories	Piano 1, Piano 2, Electric Piano, Drawbar, Church Organ, Harpsi&Mallets, Strings, Choir&Pad, Bass, Others
■ Effects	Reverb (Room1/2, Stage, Hall1/2, Plate), Chorus (1/2/3/4/FB), Flanger, Tremolo, Delay (1/2/3), Rotary (1/2)
■ Temperaments	Equal (Piano Only), Mersenne pure (Major), Mersenne pure (minor), Pythagorea, Meantone, Werckmeister III, Kirnberger III, Equal (flat), Equal
■ Other Features	Demo (32 Preset Songs), Concert Magic (88 Preset Songs), Volume, Dual, Split, Four Hands, Balance Slider, Transpose, Tune, Lower Octave Shift, Lower Pedal On/Off, Touch Curve (Light, Light +, Normal, Heavy, Heavy +, Off), MIDI (16 part multi-timbral capability), Damper Hold, Damper Effect, String Resonance, User Memory, Factory Reset
■ Lesson Function	Right/left part balance adjustable, Tempo adjustable. Please refer to the separate 'Concert Magic Song List/Lesson Song List' booklet for a complete listing of available lesson songs.
■ Internal Recorder	2 Tracks, 3 Songs. The total memory capacity of the recorder is approximately 90,000 notes.
■ USB Recorder	16 Tracks, Realtime recording, SMF format
■ Metronome	Beat: 1/4, 2/4, 3/4, 4/4, 5/4, 3/8, 6/8, 7/8, 9/8, 12/8 Rhythm: 100 types
■ Pedals	Sustain, Sostenuto, Soft
■ Jacks	Headphones (2), LINE IN (L/MONO, R), LINE OUT (L/MONO, R), MIDI (IN, OUT, THRU), USB (TO HOST, TO DEVICE x 2)
■ Output Power	40 W x 2
■ Speakers	16 cm x 2, 5 cm x 2
■ Key Cover	Slide type
■ Power Consumption	80 W
■ Dimensions WxDxH (with music rack flattened)	138 cm x 47 cm x 88 cm
■ Weight (without bench)	57 kg

◇ MIDI EXCLUSIVE DATA FORMAT

1st byte	2nd byte	3rd byte	4th byte	5th byte	6th byte	7th byte	9th byte	9th byte	10th byte
1	2	3	4	5	6	7	8	9	10

- 1 F0 Start code
- 2 40.....KAWAI's ID number
- 3 00 - 0FMIDI channel
- 4 10, 30.....Function code (30 when setting MULTI TIMBRE ON/OFF)
- 5 04.....Indicates that the instrument is Electronic Piano
- 6 08.....Indicates that the piano is "CN4X"
- 7 data 1
- 8 data 2.....(See the table below.)
- 9 data 3
- 10 F7End code

data 1	data 2	data 3	Function
00	00	—	Multi Timbre Off
00	01	—	Multi Timbre On 1
00	02	—	Multi Timbre On 2
0D	00-0C	—	00: Effect Off, 01: Chorus 3, 02: Delay 1, 03: Delay 2, 04: Delay 3, 05: Tremolo, 06: Rotary 1, 07: Rotary 2, 08: Chorus 1, 09: Chorus 2 0a: Chorus 4, 0b: EB Chorus, 0c: Flanger
0E	00-03, 06-08	—	00: Reverb Off, 01: Room 2, 02: Stage, 03: Hall 1, 06: Room 1, 07: Hall 2, 08: Plate
14	00-7F	—	Dual/Split balance
16	1F-60	—	Tune, 40: 440 Hz
17	00, 7F	—	00: Program Change Off, 7F: Program Change On
18	00-07	—	00: Light, 01: Normal, 02: Heavy, 03: Off, 04: Light+, 05: Heavy+, 06: User 1, 07: User 2
19	00-03	—	Lower Octave Shift
20	00-7F	00-7F	Dual Program Change, data 2: Right sound, data 3: Left sound
21	00-7F	00-7F	Split Program Change, data 2: Upper sound, data 3: Lower sound
22	00-7F	00-7F	Four Hands, data 2:Right sound, data 3:Left sound
25	00-08	00-0B	data 2: Temperament, data 3: Key
26	00, 7F	00-0F	Multi Timbre, data 2: 00 (On), 7F (Off), data 3: channel
27	00-02	00-02	Dual/Split, Right (Upper)/Left (Lower), sound Bank LSB

◇ MIDI IMPLEMENTATION CHART

KAWAI DIGITATL PIANO
MODEL : CN42

Date : December 2008
Version : 1. 0

Function		Transmit	Receive	Remarks
Basic channel	Default	1	1 - 16	
	Changes	1 - 16	1 - 16	
Mode	Default	3	3	
	Messages	×	3, 4	
	Altered	*****		
Note number		21 - 108*	0 - 127	* 9 - 120 w/Transpose
	True voice	*****	0 - 127	
Velocity	Note ON	○ 9nH v=1-127	○	
	Note OFF	× 9nH v=0	×	
After touch	Key's	×	×	
	Channel's	×	○	
Pitch bend		×	○	
Control change	0, 32	○	○	Bank Select
	1	×	○	Modulation
	5	×	○	Portament Time
	6, 38	×	○	Data Entry
	7	○	○	Volume
	10	×	○	Panpot
	11	×	○	Expression Pedal
	64	○ (Right pedal)	○	Sustain Pedal
	65	×	○	Portament
	66	○ (Center pedal)	○	Sostenuto Pedal
	67	○ (Left pedal)	○	Soft Pedal
	69	○	○	Hold 2
	70	×	○	Sustain Level
	71	×	○	Resonance
	72	×	○	Release Time
	73	×	○	Attack Time
	74	×	○	Cutoff
	75	×	○	Decay Time
	76	×	○	Vibrato Speed
	77	×	○	Vibrato Depth
78	×	○	Vibrato Delay	
84	×	○	Portament Control	
91	○	○	Reverb Send Level	
93	○	○	Chorus Send Level	
98, 99	×	○	NRPN LSB, MSB	
100, 101	×	○	RPN LSB, MSB	
Program change		○ 0 - 127	○	
	True #	*****		
System exclusive		○	○	
Common	Song Position	×	×	
	Song Select	×	×	
	Tune	×	×	
System Real time	Clock	○	○	
	Commands	○ FA, FB, FC	○	
Aux	All sound Off	×	○ (120)	
	Reset all controller	×	○ (121)	
	Local On / Off	×	×	
	All notes Off	×	○ (123 - 127)	
	Active Sense	○	○	
	Reset	×	×	
Notes				

Mode 1: omni mode On, Poly, Mode 2: omni mode On, Mono
Mode 3: omni mode Off, Poly, Mode 4: omni mode Off, Mono

○: Yes
×: No

KAWAI

THE FUTURE OF THE PIANO

CN42 Owner's Manual
KPSZ-0281 : 816461
OW1012E-S0812
Version.1

Printed in Indonesia

Copyright © 2008 KAWAI Musical Instruments Mfg. Co.,Ltd. All Rights Reserved.