

KAWAI

DIGITAL PIANO

CN43

Owner's Manual

PART NAMES
AND FUNCTIONS
1

PLAYING
THE PIANO
2

LESSON
FUNCTION
3

INTERNAL
RECORDER
4

USB
RECORDER
5

USB
OPERATIONS
6

RHYTHM
SECTION
7

MENU
FUNCTIONS
8

APPENDICES
9

Thank you for purchasing a KAWAI CN43 digital piano!

The CN43 digital piano is a revolutionary new instrument that combines the latest digital technology with traditional piano craftsmanship inherited from KAWAI's many years of experience in building fine acoustic pianos. The authentic tone has been created through the stereo sampling of concert grand pianos, and is reproduced using KAWAI's unique Harmonic Imaging™ sound technology, while the Responsive Hammer Action keyboard action provides the touch response and full dynamic range required for a superb performance of piano, harpsichord, organ, and other instruments.

The CN43 digital piano is also equipped with additional reverb and digital effects processors, delivering a deeper, richer sound, while industry standard MIDI jacks and a USB interface are also provided, allowing the playback of other electronic instruments and connection with personal computers / USB memory, while the Lesson function helps performers to practice the piano with a collection of etudes from Czerny and Burgmuller, or songs from Alfred's Basic Piano Library and Alfred's Premier Piano Course lesson books (USA, Canada, Australia and UK only).

This owner's manual contains useful information regarding the varied capabilities of the CN43 digital piano. Please read all sections carefully and keep this manual handy for future reference.

Table of Contents

◆ Important Safety Instructions	4	7. RHYTHM SECTION	52
1. PART NAMES AND FUNCTIONS	8	◇ RHYTHM SECTION OVERVIEW	52
◇ FRONT PANEL	8	1) ACTIVATING THE RHYTHM SECTION	53
◇ PEDALS	8	2) PLAYING WITH THE RHYTHM SECTION	54
◇ HEADPHONES	9	3) RHYTHM SECTION STYLES	55
◇ USB PORT	9	◇ SELECTING THE RHYTHM SECTION STYLE	55
2. PLAYING THE PIANO	10	◇ SELECTING THE RHYTHM SECTION GENRE	56
1) BASIC OPERATIONS	10	4) RHYTHM SECTION PARTS	57
◇ SETTING UP THE PIANO	10	5) ADJUSTING THE RHYTHM SECTION TEMPO	58
◇ DEMO SONGS	11	6) ADJUSTING THE RHYTHM SECTION VOLUME	59
◇ SELECTING A PRESET SOUND	12	7) ADJUSTING THE RHYTHM SECTION SPLIT POINT	60
2) DUAL	13	8) PRESET CHORD PROGRESSION	61
3) SPLIT	14	◇ ACTIVATING PRESET CHORD PROGRESSION MODE	61
4) FOUR HANDS MODE	16	◇ SELECTING THE PRESET CHORD PROGRESSION STYLE	61
◇ ENTERING FOUR HANDS MODE	16	◇ DEACTIVATING PRESET CHORD PROGRESSION MODE	61
◇ EXITING FOUR HANDS MODE	16	9) RECORDING THE RHYTHM SECTION	62
5) EFFECTS/REVERB	17	10) RECORDING THE RHYTHM SECTION TO AN AUDIO FILE	64
◇ ADDING REVERB	17	8. MENU FUNCTIONS	65
◇ ADDING OTHER EFFECTS	18	1) BRILLIANCE	65
6) TRANSPOSING THE PIANO	19	2) LOWER OCTAVE SHIFT	66
7) PLAYING WITH CONCERT MAGIC	20	3) LOWER PEDAL ON / OFF	66
◇ SELECTING A SONG	20	4) LAYER OCTAVE SHIFT	67
◇ LISTENING TO THE SONG	20	5) LAYER DYNAMICS	68
◇ PERFORMING A SONG	21	6) DAMPER HOLD ON / OFF	69
◇ CONCERT MAGIC PART VOLUME BALANCE	22	7) DAMPER EFFECT	70
◇ CONCERT MAGIC SONG ARRANGEMENT TYPES	22	8) STRING RESONANCE	71
◇ STEADY BEAT	23	9) FOUR HANDS ON/OFF	72
◇ CONCERT MAGIC DEMO MODES	24	10) TUNING	73
◇ CONCERT MAGIC PLAYBACK SPEED	24	11) TEMPERAMENT	74
8) METRONOME	25	12) KEY OF TEMPERAMENT	76
◇ STARTING THE METRONOME	25	13) TOUCH	77
◇ CHANGING THE TIME SIGNATURE	25	14) AUTO FILL-IN	78
◇ ADJUSTING THE METRONOME VOLUME	26	15) ONE FINGER AD-LIB™ ON/OFF	79
9) PANEL LOCK	27	◇ MIDI OVERVIEW	80
3. LESSON FUNCTION	28	◇ CN43 MIDI FUNCTIONS	80
1) SELECTING A BOOK/SONG	28	16) MIDI CHANNEL	81
2) LISTENING TO AND PLAYING A SONG	29	17) TRANSMIT PROGRAM CHANGE ON / OFF	82
◇ EXITING THE LESSON FUNCTION	29	18) LOCAL CONTROL ON / OFF	83
◇ PRACTICING THE LEFT AND RIGHT-HAND PARTS	29	19) MULTI-TIMBRAL MODE	84
◇ ADJUSTING THE TEMPO OF A SONG	29	20) CHANNEL MUTE	85
3) RECORDING A SONG PRACTICE	30	21) SENDING PROGRAM CHANGE NUMBERS	86
◇ PLAYING BACK THE RECORDING	30	22) MIDI CLOCK	87
◇ ERASING THE RECORDING	30	23) USER MEMORY	87
4. INTERNAL RECORDER	31	24) FACTORY RESET	88
1) RECORDING (REC BUTTON)	31	9. APPENDICES	89
2) PLAYING BACK A SONG	33	◇ CONNECTING TO OTHER DEVICES	89
3) TRANSPOSING A SONG	34	◇ USB MIDI	90
4) ERASING A SONG	35	◇ ASSEMBLY INSTRUCTIONS	91
5. USB RECORDER	36	◇ PROGRAM CHANGE NUMBER MAPPING	93
1) RECORDING AN AUDIO FILE	36	◇ DRUM SOUND MAPPING	101
2) PLAYING AN AUDIO FILE	38	◇ RHYTHM SECTION STYLE LIST	104
3) RECORDING AN SMF SONG	40	◇ RHYTHM SECTION CHORD TYPES	105
4) PLAYING AN SMF SONG	42	◇ PRESET CHORD PROGRESSION STYLES	109
5) RECORDING TO AN EXISTING SMF SONG	44	◇ SPECIFICATIONS	111
6) CONVERTING A SONG TO AN AUDIO FILE	46	◇ MIDI EXCLUSIVE DATA FORMAT	112
6. USB OPERATIONS	48	◇ MIDI IMPLEMENTATION CHART	113
1) INTERNAL SONG SAVE	49		
2) RENAME FILE	49		
3) DELETE FILE	50		
4) MAKE DIR	50		
5) FORMAT USB	51		

Important Safety Instructions

SAVE THESE INSTRUCTIONS

INSTRUCTIONS PERTAINING TO A RISK OF FIRE, ELECTRIC SHOCK, OR INJURY TO PERSONS



WARNING

TO REDUCE THE RISK OF FIRE OR ELECTRIC SHOCK, DO NOT EXPOSE THIS PRODUCT TO RAIN OR MOISTURE.

AVIS : RISQUE DE CHOC ELECTRIQUE - NE PAS OUVRIR.

TO REDUCE THE RISK OF ELECTRIC SHOCK, DO NOT REMOVE COVER (OR BACK). NO USER-SERVICEABLE PARTS INSIDE. REFER SERVICING TO QUALIFIED SERVICE PERSONNEL.



The lightning flash with arrowhead symbol, within an equilateral triangle, is intended to alert the user to the presence of uninsulated "dangerous voltage" within the product's enclosure that may be of sufficient magnitude to constitute a risk of electric shock to persons.



The exclamation point within an equilateral triangle is intended to alert the user to the presence of important operating and maintenance (servicing) instructions in the literature accompanying the product.

Examples of Picture Symbols



denotes that care should be taken.
The example instructs the user to take care not to allow fingers to be trapped.



denotes a prohibited operation.
The example instructs that disassembly of the product is prohibited.



denotes an operation that should be carried out.
The example instructs the user to remove the power cord plug from the AC outlet.

Read all the instructions before using the product.

- 1) Read these instructions.
- 2) Keep these instructions.
- 3) Heed all warnings.
- 4) Follow all instructions.
- 5) Do not use this apparatus near water.
- 6) Clean only with dry cloth.
- 7) Do not block any ventilation openings. Install in accordance with the manufacturer's instructions.
- 8) Do not install near any heat sources such as radiators, heat registers, stoves, or other apparatus (including amplifiers) that produce heat.
- 9) Do not defeat the safety purpose of the polarized or grounding-type plug. A polarized plug has two blades with one wider than the other. A grounding type plug has two blades and a third grounding prong. The wide blade or the third prongs are provided for your safety. If the provided plug does not fit into your outlet, consult an electrician for replacement of the obsolete outlet.
- 10) Protect the power cord from being walked on or pinched particularly at plugs, convenience receptacles, and the point where they exit from the apparatus.
- 11) Only use attachments/accessories specified by the manufacturer.
- 12) Use only with the cart, stand, tripod, bracket, or table specified by the manufacturer, or sold with the apparatus. When a cart is used, use caution when moving the cart/apparatus combination to avoid injury from tip-over. 
- 13) Unplug this apparatus during lightning storms or when unused for long periods of time.
- 14) Refer all servicing to qualified service personnel. Servicing is required when the apparatus has been damaged in any way, such as power-supply cord or plug is damaged, liquid has been spilled or object have fallen into the apparatus, the apparatus has been exposed to rain or moisture, does not operate normally, or has been dropped.

WARNING - When using electric products, basic precautions should always be followed, including the following.



WARNING

Indicates a potential hazard that could result in death or serious injury if the product is handled incorrectly.

The product should be connected to an AC outlet of the specified voltage.



- If you are going to use an AC power cord, make sure that its has the correct plug shape and conforms to the specified power voltage.
- Failure to do so may result in fire.

Do not insert or disconnect the power cord plug with wet hands.



Doing so may cause electric shock.

The chair must be used properly (it must be used only when playing the product).

- Do not play with it or stand on it.
- Only one person is allowed to sit on it.
- Do not sit on it when opening the lid.
- Re-tighten the bolts occasionally.

Doing so may cause the chair to fall over or your fingers to be trapped, resulting in injury.

When using the headphones, do not listen for long periods of time at high volume levels.

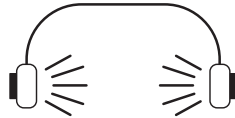

Doing so may result in hearing problems.

Do not lean against the keyboard.

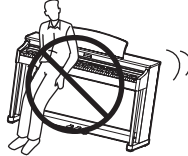

Doing so may cause the product to fall over, resulting in injury.

Do not disassemble, repair or modify the product.

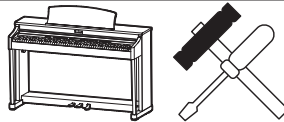

Doing so may result in product breakdown, electric shock or short-circuit.

When disconnecting the AC power cord's plug, always hold the plug and pull it to remove it.



- Pulling the AC power cord itself may damage the cord, causing a fire, electric shock or short-circuit.

The product is not completely disconnected from the power supply even when the power switch is turned off. If the product will not be used for a long time, unplug the AC power cord from the AC outlet.



- Failure to do so may cause fire in case of lightning.
- Failure to do so may over-heat the product, resulting in fire.

This product may be equipped with a polarized line plug (one blade wider than the other). This is a safety feature. If you are unable to insert the plug into the outlet, contact an electrician to replace your obsolete outlet. Do not defeat the safety purpose of the plug.

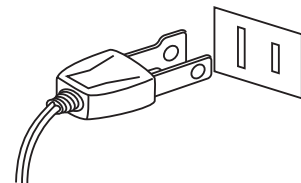

This product shall be near the AC outlet and the power cord plug in a position so that it can readily be disconnected in an emergency because electricity is always charging while the plug is in the AC outlet even in a power switch off condition.



CAUTION

Indicates a potential hazard that could result in injury or damage to the product or other property if the product is handled incorrectly.

Do not use the product in the following areas.

- Areas, such as those near windows, where the product is exposed to direct sunlight
- Extremely hot areas, such as near a heater
- Extremely cold areas, such as outside
- Extremely humid areas
- Areas where a large amount of sand or dust is present
- Areas where the product is exposed to excessive vibrations

Using the product in such areas may result in product breakdown. Use the product only in moderate climates (not in tropical climates).

When you close the keyboard cover, close it gently.



Closing it roughly may trap your fingers, resulting in injury.

Before connecting cords, make sure that the power to this product and other devices is turned OFF.

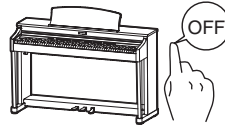

Failure to do so may cause breakdown of this product and other devices.

Take care not to allow any foreign matter to enter the product.

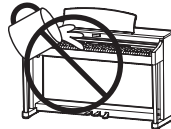

Entry of water, needles or hair pins may result in breakdown or short-circuit. The product shall not be exposed to dripping or splashing. No objects filled with liquids, such as vases, shall be placed on the product.

Do not drag the product on the floor. Take care not to drop the product.

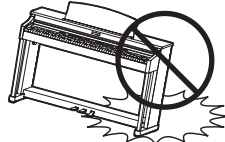

Please lift up the product when moving it. Please note that the product is heavy and must be carried by more than two persons. Dropping the product may result in breakdown.

Do not place the product near electrical appliances such as TVs and radios.

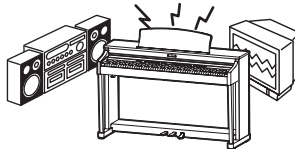

- Doing so may cause the product to generate noise.
- If the product generates noise, move the product sufficiently away from the electrical appliance or connect it to another AC outlet.

When connecting the AC power cord and other cords, take care not to get them tangled.



Failure to do so may damage them, resulting in fire, electric shock or short-circuit.

Do not wipe the product with benzene or thinner.



- Doing so may result in discoloration or deformation of the product.
- When cleaning the product, put a soft cloth in lukewarm water, squeeze it well, then wipe the product.

Do not stand on the product or exert excessive force.



- Doing so may cause the product to become deformed or fall over, resulting in breakdown or injury.

Do not place naked flame, such as lighted candles on the product.

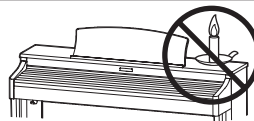

Doing so may cause the illumination to fall over, resulting in fire.

Ensure that the ventilation is not impeded by covering the ventilation openings with items, such as newspaper, table-cloths, curtains, etc.

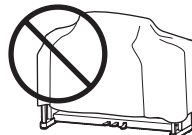

Failure to do so may over-heat the product, resulting in fire.

The product should be located so that its location or position does not interfere with its proper ventilation. Ensure a minimum distance of 5cm around the product for sufficient ventilation.

The product should be serviced by qualified service personnel when:

- The power supply cord or the plug has been damaged.
- Objects have fallen, or liquid has been spilled into the product.
- The product has been exposed to rain.
- The product does not appear to operate normally or exhibits a marked change in performance.
- The product has been dropped, or the enclosure damaged.

Notes on Repair

Should an abnormality occur in the product, immediately turn the power OFF, disconnect the power cord plug, and then contact the shop from which the product was purchased.

CAUTION:

To prevent electric shock, match wide blade of plug to wide slot, fully insert.

ATTENTION:

Pour éviter les chocs électriques, introduire la lame la plus large de la fiche dans la borne correspondante de la prise et pousser jusqu'au fond.

Instruction for AC power cord (U.K.)

Do not plug either terminal of the power cord to the ground of the AC outlet on the wall.

Canadian Radio Interference Regulations

This instrument complies with the limits for a class B digital apparatus, pursuant to the Radio Interference Regulations, C.R.C., c. 1374.

**An information on Disposal for users**

If your product is marked with this recycling symbol it means that, at the end of its life, you must dispose of it separately by taking it to an appropriate collection point.

You should not mix it with general household waste. Disposing of this product correctly will prevent potential negative effects on the environment and human health which could otherwise arise due to inappropriate waste handling.

For further details, please contact your local authority.
(European Union only)

FCC Information

This equipment has been tested and found to comply with the limits for a Class B digital device, pursuant to Part 15 of the FCC Rules. These limits are designed to provide reasonable protection against harmful interference in a residential installation. This equipment generates, uses and can radiate radio frequency energy and, if not installed and used in accordance with the instructions, may cause harmful interference to radio communications. If this equipment does cause harmful interference to radio or television reception, which can be determined by turning the equipment off and on, the user is encouraged to try to correct the interference by one or more of the following measures:

- Reorient or relocate the receiving antenna.
- Increase the separation between the equipment and receiver.
- Connect the equipment into an outlet on a different electrical circuit from the receiver.
- Consult the dealer or an experienced radio/TV technician for help.

FCC WARNING

Changes or modifications not expressly approved by the party responsible for compliance could void the user's authority to operate the equipment.

The nameplate label is located on the underside of the instrument, as indicated below.

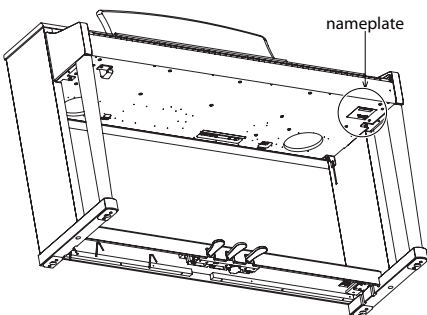
**Declaration of Conformity**

This device complies with Part 15 of the FCC Rules. Operation is subject to the following two conditions: (1) this device may not cause harmful interference, and (2) this device must accept any interference received, including interference that may cause undesired operation.

Model Name :	CN43
Responsible Party Name :	Kawai America Corporation
Address :	2055 East University Drive Rancho Dominguez, CA 90220
Telephone :	310-631-1771

This applies only to products distributed by Kawai America Corporation.

1. PART NAMES AND FUNCTIONS

This section explains the locations and functions of the panel buttons and sliders.

◇ FRONT PANEL

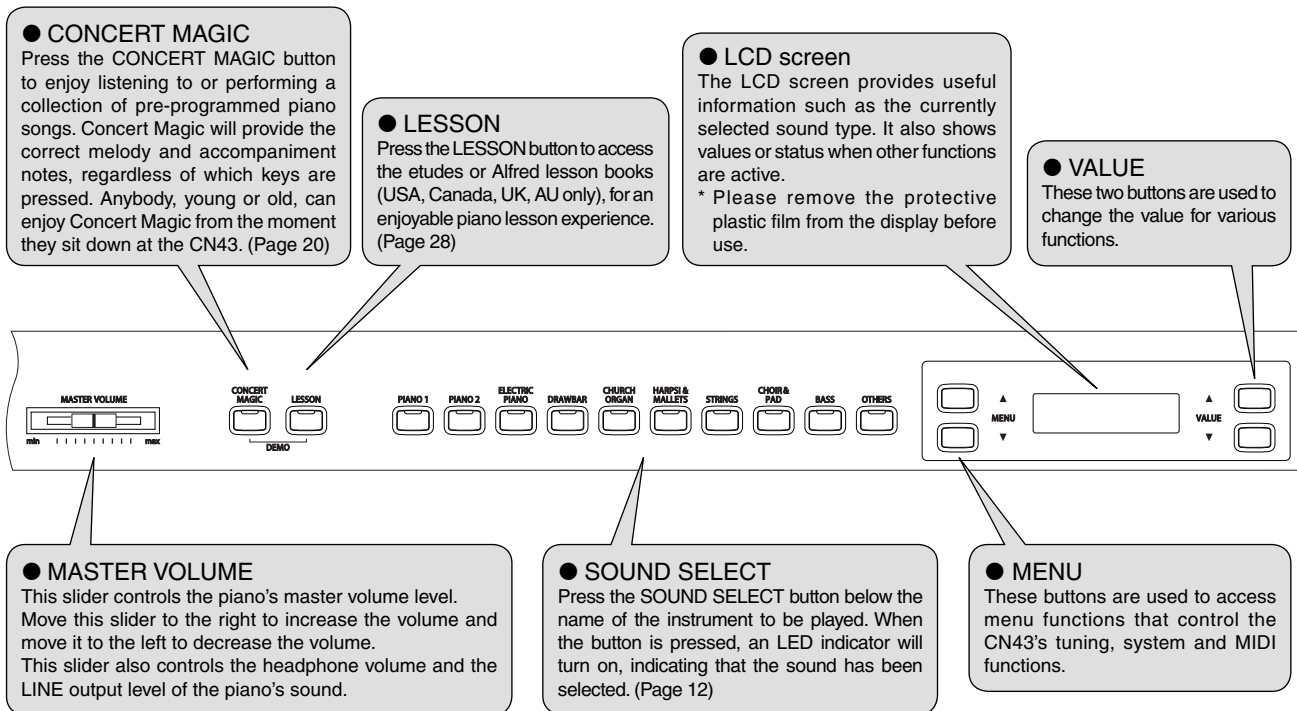

◇ PEDALS

The CN43 piano has three pedals—just like a grand piano. They are Sustain, Sostenuto and Soft.

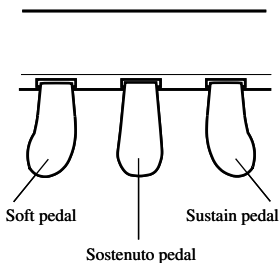

◆ Sustain pedal

Sustains the sound after hands are lifted from the keyboard. The sustain pedal is capable of responding to half pedaling.

◆ Sostenuto pedal

Depressing this pedal after playing the keyboard and before releasing the keys sustains the sound of only the keys just played. Any keys that are pressed after the Sostenuto pedal is depressed will not be sustained after the keys are released.

◆ Soft pedal

Depressing this pedal softens the sound and reduces its volume. When the rotary effect is active the soft pedal is used to change the speed of the rotor between slow and fast.

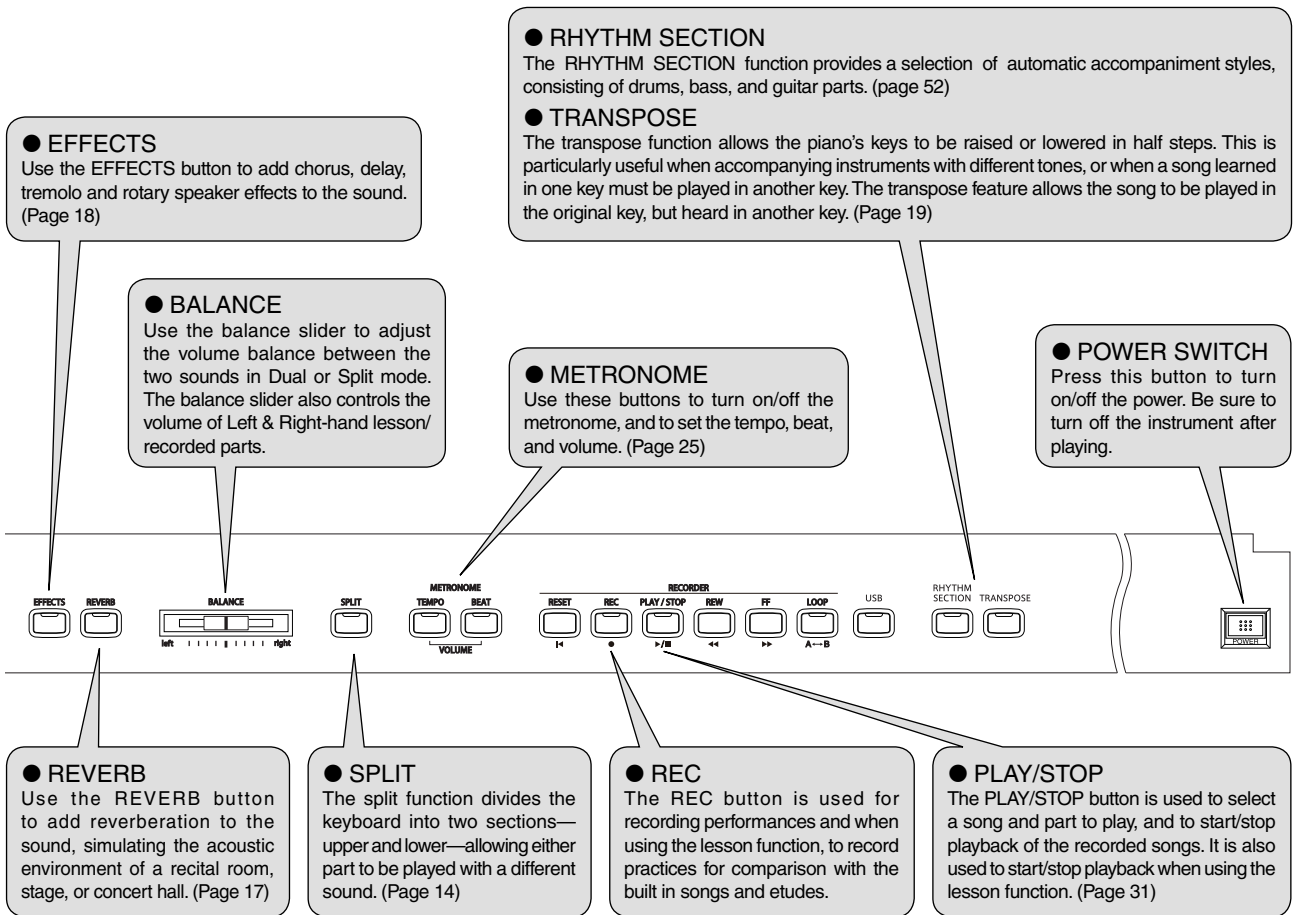

◆ HEADPHONES

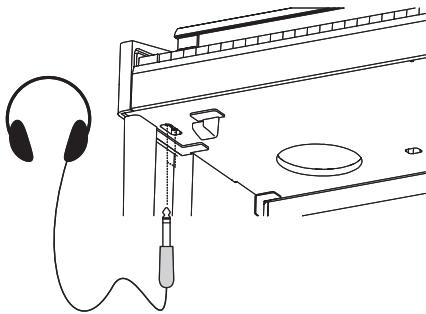

◆ Headphone jack (x 2)

There are two headphone jacks located on the left underside of the piano.

Up to two pairs of headphones can be connected simultaneously.

- See page 92 for information on attaching the headphone hooks.

◆ USB PORT

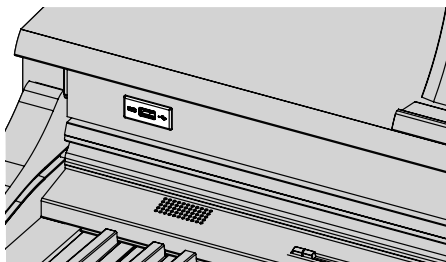

This USB (to Device) port allows USB memory devices to be connected to the CN43 piano. This provides a convenient way to record and play back MP3/WAV audio files and 16 track SMF (Standard MIDI File) format songs.

2. PLAYING THE PIANO

1) BASIC OPERATIONS

This section provides the basic procedures for turning the power on and playing the CN43 piano.

◇ SETTING UP THE PIANO

The CN43 piano is equipped with stereo speakers and an amplifier—no additional equipment is required to begin playing the instrument, provided AC power is available.

□ Step 1

Connect one end of the AC power cable to the piano's power jack and the other end of the cable to a wall AC outlet.

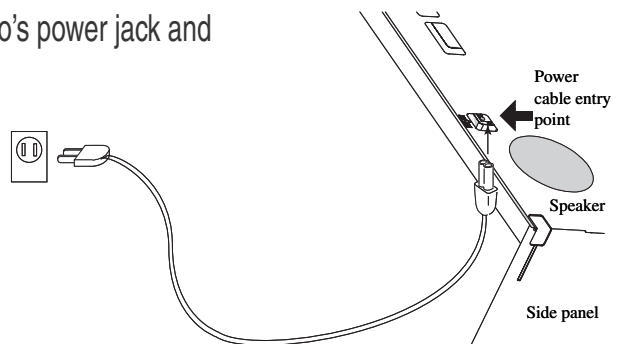

□ Step 2

Press the POWER SWITCH to turn on the power.

The POWER SWITCH is located at the right end of the front panel.

Press the POWER SWITCH again to turn off the power. When the POWER button is pressed, the LED indicator for the PIANO1 button will turn on and the Concert Grand sound will automatically be selected.

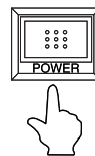

'Concert Grand' will also be shown in the LCD screen.

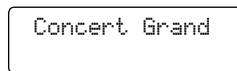

□ Step 3

Adjust the volume level using the MASTER VOLUME slider.

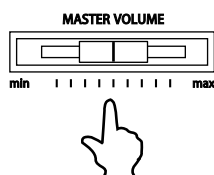

The MASTER VOLUME slider controls the volume level of the speakers and connected headphones.

Move this slider to the right to increase the volume and move it to the left to decrease the volume.

Use this slider to set the volume to a comfortable listening level—the middle is often a good starting point.

◇ DEMO SONGS

The CN43 includes 34 built-in sound demo songs. Each of the demo songs presents a musical piece to introduce the different preset sounds.

PIANO 1		HARPSI & MALLETS	
Concert Grand	: KAWAI	Harpischord	: French Suite No.6 / Bach
Studio Grand	: KAWAI	Vibraphone	: KAWAI
Mellow Grand	: Sonata No.30 Op.109 / Beethoven	Clavi	: KAWAI
Modern Piano	: KAWAI	STRINGS	
PIANO 2		Slow Strings	: KAWAI
Concert Grand 2	: Waltz No.6 Op.64-1 "Petit Chien" /Chopin	String Pad	: KAWAI
Studio Grand 2	: KAWAI	String Ensemble	: Le quattro stagioni La primavera / Vivaldi
Mellow Grand 2	: La Fille aux Cheveux de lin / Debussy	CHOIR & PAD	
Rock Piano	: KAWAI	Choir	: Londonderry Air / Irish folk song
ELECTRIC PIANO		Choir 2	: KAWAI
Classic E.P.	: KAWAI	New Age	: KAWAI
Modern E.P.	: KAWAI	Atmospher	: KAWAI
Modern E.P. 2	: KAWAI	BASS	
DRAWBER		Wood Bass	: KAWAI
Jazz Organ	: KAWAI	Fretless Bass	: KAWAI
Drawbar Organ	: KAWAI	W. Bass & Ride	: KAWAI
Drawbar Organ 2	: KAWAI	OTHERS	
CHURCH ORGAN			Rhapsody Op.79 No.2 / Brahms
Church Organ	: Chorale Prelude "Wachet auf, ruft uns die Simme." / Bach		Piano Concerto a minor Op.16 / Grieg
Diapason	: Wohl mir, daß ich Jesum habe / Bach	RHYTHM SECTION	
Full Ensemble	: KAWAI		KAWAI
			KAWAI

KAWAI regret that sheet music for KAWAI original demo songs is not available.

□ Step 1

Press the **CONCERT MAGIC** and **LESSON** buttons simultaneously.

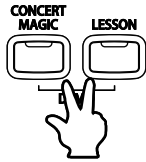

The LED indicators for the **CONCERT MAGIC** button and the **LESSON** button will turn on and the **SOUND SELECT** buttons will start to flash.

The demo song for the **PIANO 1** category will start. After the **PIANO 1** demo songs have finished playing, the demo songs for another sound category or the **RHYTHM SECTION** will be selected at random.

- There are 4 songs stored for the **PIANO1** sound, which will be played in order. Pressing the **PIANO1** button repeatedly will select the next piano song.

□ Step 2

Press the other **SOUND SELECT** buttons while the demo is playing to listen to demos from each category.

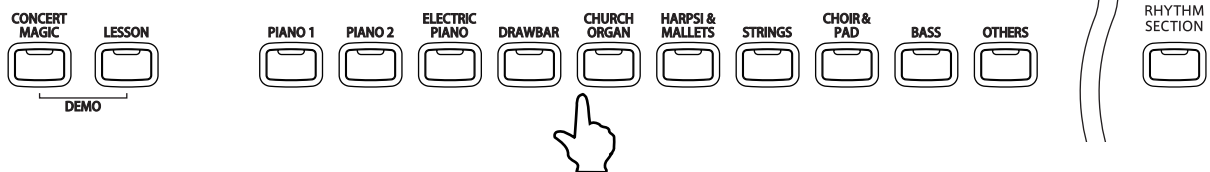

- When this button is pressed, demo songs for the newly selected category will be played. Demo songs from another category will then be selected at random.

□ Step 3

Press the **CONCERT MAGIC** button, the **LESSON** button or the **PLAY/STOP** button to exit the demo mode.

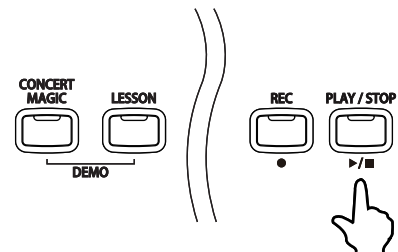

◇ SELECTING A PRESET SOUND

□ Step 1

Press the SOUND SELECT button below the name of the instrument to be played.

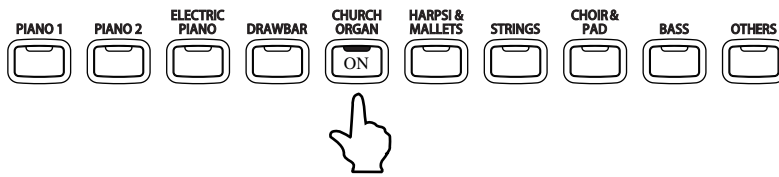

When the button is pressed, the LED indicator will turn on, indicating that this sound has been selected.

The name of the selected preset sound is also shown in the LCD screen. Multiple sounds are assigned to each button; pressing the same SOUND SELECT button again will select the next variation sound assigned to that SOUND SELECT button.

To select a Church Organ sound, press the CHURCH ORGAN button as shown above. The LED indicator for the CHURCH ORGAN button will turn on.

■ Preset sounds can also be selected by pressing the VALUE buttons.

■ The OTHERS button is assigned with 299 sounds, divided into 20 additional categories. While holding down one of the VALUE buttons, pressing the other VALUE button will jump to the next sound category within the OTHERS selection.



■ PRESET SOUNDS

■PIANO 1	Concert Grand	■HARPSI & MALLETS	Harpichord
	Studio Grand		Harpichord 2
	Mellow Grand		Vibraphone
	Modern Piano		Clavi
■PIANO 2	Concert Grand 2	■STRINGS	Slow Strings
	Studio Grand 2		String Pad
	Mellow Grand 2		Warm Strings
	Rock Piano		String Ensemble
■ELECTRIC PIANO	Classic E.P.	■CHOIR & PAD	Choir
	Modern E.P.		Choir 2
	60's E.P.		New Age
	Modern E.P. 2		Atmosphere
■DRAWBAR	Jazz Organ	■BASS	Wood Bass
	Drawbar Organ		Electric Bass
	Drawbar Organ 2		Fretless Bass
	Be 3		W. Bass & Ride
■CHURCH ORGAN	Church Organ	■OTHERS	299 sounds
	Diapason		
	Full Ensemble		
	Diapason Oct.		

Please refer to 'PROGRAM CHANGE NUMBER MAPPING' on page 93 for a complete listing of the additional 299 sounds assigned to the OTHERS button.

□ Step 2

Play the keyboard.

The selected sound will be heard as the keys are pressed.

Use the MASTER VOLUME slider to adjust the volume if necessary.

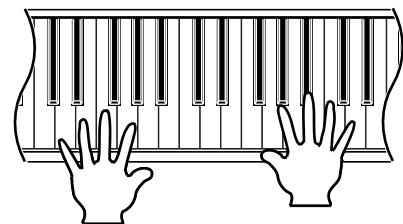

■ The CN43 piano is capable of playing up to 192 notes simultaneously (192-note polyphony). However, when playing in dual mode, or when playing a stereo piano sound, the polyphony will be reduced by half because the piano has to produce two sounds for each note.

2) DUAL

The DUAL function allows two preset sounds to be layered together, creating a more complex sound. For example, a piano can be layered with strings, or a church organ with a choir sound.

□ Step 1

Press and hold down a SOUND SELECT button to select the first desired sound. Then press another SOUND SELECT button to select the second desired sound.

The LED indicators for each button will turn on, indicating that the two sounds have been selected, and the names of both instruments will be shown in the LCD screen.

For example, to layer a piano sound and a string sound, press the PIANO 1 and STRINGS buttons simultaneously as shown in the diagram.

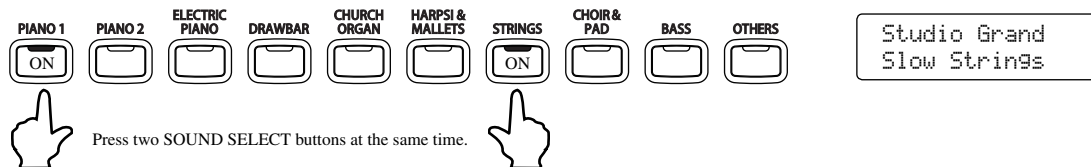

Pressing either of the SOUND SELECT buttons again will select the other sound variations assigned to that button.

For example, to change the Slow Strings sound to String Pad, press and hold the PIANO 1 button and press the STRINGS button again.

If two sound variations assigned to the same SOUND SELECT button are to be layered, while pressing the desired SOUND SELECT button, use the VALUE buttons to select the desired sound variation. For example, to layer Concert Grand and Mellow Grand together, first press the PIANO 1 button to select Concert Grand, and then use the VALUE buttons to select Mellow Grand while still holding down the PIANO 1 button.

□ Step 2

Play the keyboard.

Two different sounds will be heard at the same time.

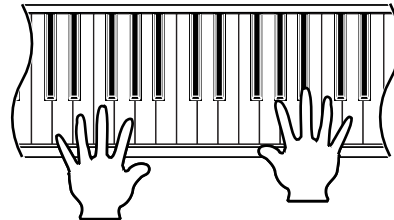

□ Step 3

Use the BALANCE slider to adjust the volume balance between the two sounds.

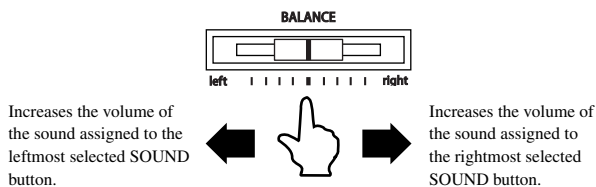

□ Step 4

Press any individual SOUND SELECT button to cancel DUAL mode.

3) SPLIT

The SPLIT function divides the keyboard into two sections—upper and lower—allowing each part to be played with a different sound.

□ Step 1

Press the SPLIT button.

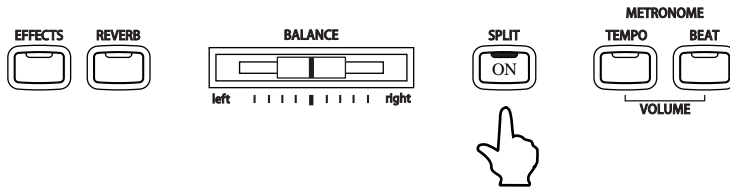

The LED indicator for the SPLIT button will turn on.

The LED indicator for the upper SOUND SELECT button will also be turned on, while the LED indicator for the lower SOUND SELECT button will start to flash.

The names of the selected upper and lower sounds will also be shown in the LCD screen.

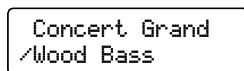

The '/' symbol will be displayed in the bottom left corner of the LCD screen, indicating that split mode has been activated.

The default split point is set between F#2 and G2. This point can be moved to any key on the keyboard.

□ Step 2

Press and hold the SPLIT button, then press a key on the keyboard.

The pressed key will become the lowermost note for the upper section.

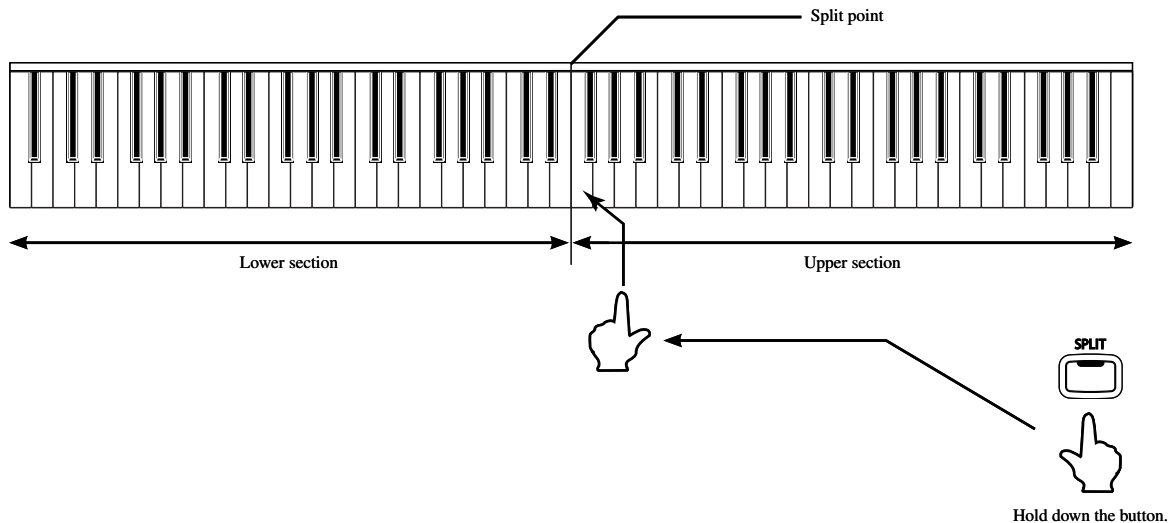

□ Step 3

Play the keyboard.

Different sounds will be produced in the upper and lower sections.

An ensemble performance can be enjoyed by playing the chords and the melody with the right hand, while playing a bass line with the left hand.

□ Step 4

To change the upper sound while SPLIT mode is enabled, press the desired SOUND SELECT button.

The LED indicator for the selected SOUND SELECT button will turn on.

Press the same button repeatedly to select another sound variation assigned to that button.

□ Step 5

To change the lower sound while SPLIT mode is enabled, press and hold the SPLIT button, then press the desired SOUND SELECT button.

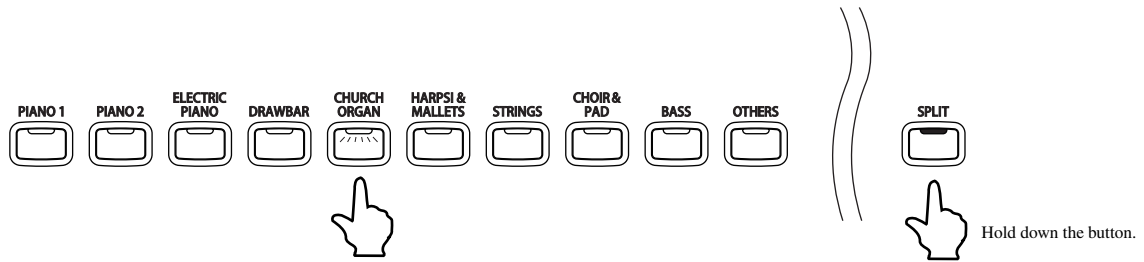

The LED indicator for the selected SOUND SELECT button will start to flash.

Press the same button repeatedly to select another sound variation assigned to that button.

□ Step 6

Use the BALANCE slider to adjust the volume balance between the upper and lower sections.

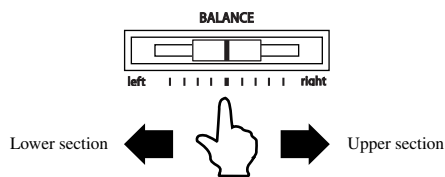

□ Step 7

Press the SPLIT button to exit the split mode.



The LED indicator for the SPLIT button will turn off.

- When SPLIT mode is enabled, 'Lower Octave Shift' can be used to adjust the octave range for the lower section. (Page 67)
- The Sustain pedal can also be turned ON / OFF for the lower section. (Page 66)

4) FOUR HANDS MODE

In FOUR HANDS mode the CN43 piano keyboard is split into upper and lower sections, allowing two players to play the piano together. The sounds in the upper section are transposed two octaves down from the original pitch, while sounds from the lower section are transposed two octaves up from the original pitch, with both players playing in the same key range. The left pedal can also be used as a damper pedal for the player sitting on the left.

◇ ENTERING FOUR HANDS MODE

□ Step 1

Press and hold the SPLIT button, then press the sustain (right) pedal and the soft (left) pedal together.

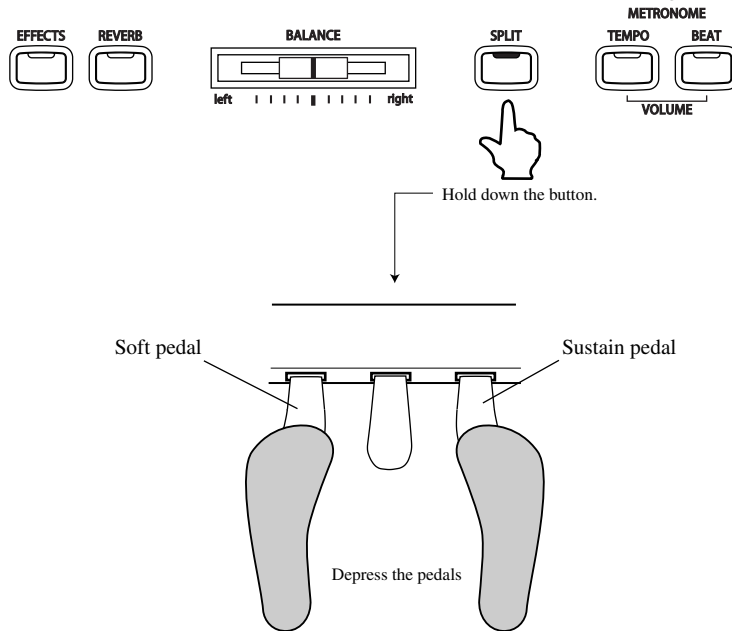

The LED indicator for the SPLIT button will start to flash, indicating that the piano is in FOUR HANDS mode.

◆ Selecting Sounds in FOUR HANDS Mode

When in FOUR HANDS mode, the method for selecting sounds is the same as in SPLIT mode. Press the desired SOUND SELECT button to change the sound for the upper section, or press and hold the SPLIT button, then press the desired SOUND SELECT button to change the sound for the lower section.

◆ Changing Split Point

When in FOUR HANDS mode, the method for changing the SPLIT point is the same as in SPLIT mode. Press and hold the SPLIT button, then press a key on the keyboard. The pressed key becomes the lowermost note for the upper section. The default SPLIT point is set between E3 and F3.

Finally, when in FOUR HANDS Mode, the OCTAVE SHIFT function can also be used to change the octave of the lower section. (Page 66)

- It is also possible to activate FOUR HANDS mode by using the FOUR HANDS ON/OFF function in the Function menu. Please refer to the instructions on page 72 for more information.

◇ EXITING FOUR HANDS MODE

□ Step 1

To exit FOUR HANDS Mode, press the SPLIT button again.

The LED indicator for the SPLIT button will turn off.

5) EFFECTS/REVERB

When selecting some preset sounds, the LED indicator for the EFFECTS or REVERB buttons may turn on automatically. This is because certain preset sounds are prepared with an effect enabled as their default setting. Adding an effect to the sound enhances tonal quality and improves acoustic realism. This CN43 piano features two separate groups of effects. The first is reverb and the second contains chorus, flanger, delay, tremolo and rotary speaker effects.

◇ ADDING REVERB

◆ REVERB

Reverb adds reverberation to the sound, simulating the acoustic environment of a recital room, stage, or concert hall. There are six types of reverb available: Room 1, Room 2, Stage, Hall 1, Hall 2 and Plate.

□ Step 1

Press the REVERB button.

The LED indicator will turn on to indicate that reverb is in use. Press and hold the REVERB button to show the currently selected reverb type in the display.

□ Step 2

To change the reverb type, use the VALUE buttons while holding down the REVERB button.

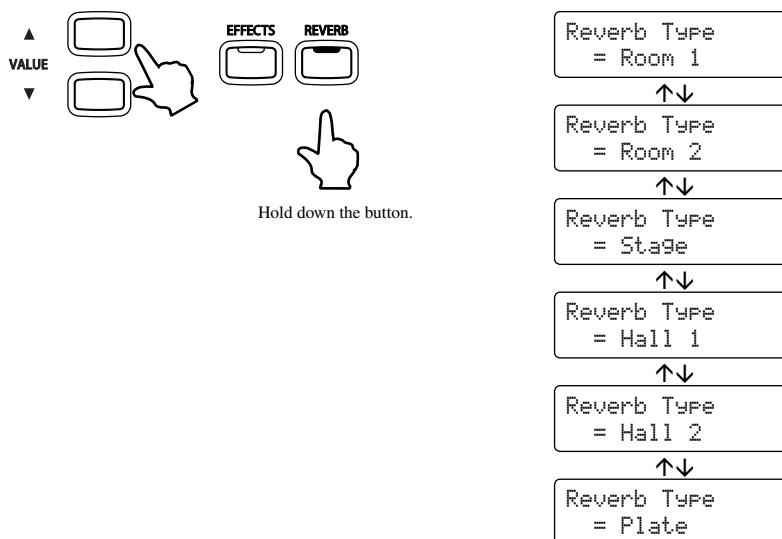

To turn off the reverb, press the REVERB button again.

Press the REVERB button once again to turn the reverb back on. The previously selected reverb type will be used.

Any changes made to the reverb type or on / off status will remain until the power is turned off.

When the power is turned off the reverb settings will return to the default settings.

◇ ADDING OTHER EFFECTS

◆ CHORUS

Chorus is an effect that simulates the rich character of a vocal choir or string ensemble, enriching the original voice by over-layering a slightly detuned version of the sound.

◆ FLANGER

Flanger creates a shifting comb-filter, which adds motion and a 'hollow' tone to the sound.

◆ DELAY

Delay is an effect that adds echoes to the sound. There are three types of delay available (delay 1, delay 2 and delay 3), each with a different length of delay between the echoes.

◆ TREMOLO

This is a vibrato type effect.

◆ ROTARY

This effect simulates the sound of the Rotary Speaker cabinet commonly used with electronic organs. Rotary 1 is normal rotary and Rotary 2 is with distortion effect. The soft pedal is used to change the speed of the rotor between SLOW and FAST.

□ Step 1

Press the EFFECTS button.

The LED indicator will turn on to indicate that the effect is in use. Press and hold the EFFECTS button to show the currently selected effect in the display.

□ Step 2

To change the effect type, press and hold the EFFECTS button and press the VALUE buttons.

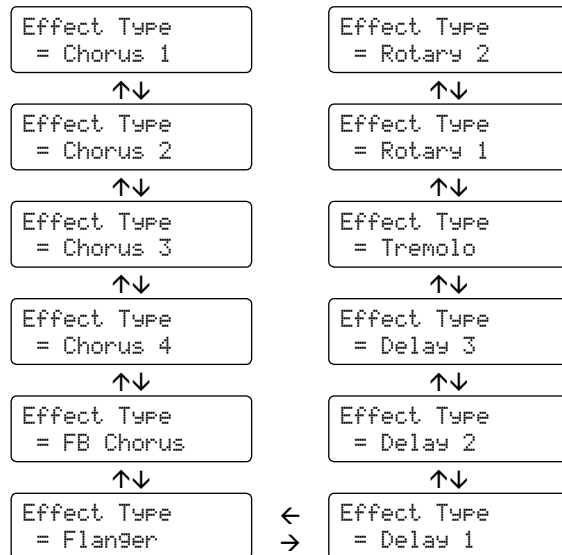
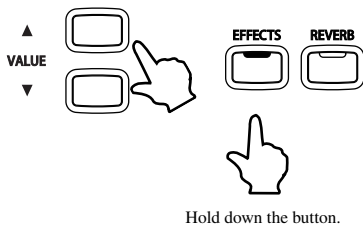

To turn off the effects, press the EFFECTS button again.

Press the EFFECTS button once again to turn the effects back on. The previously selected effect type will be used.

Any changes made to the effect type or on / off status will remain until the power is turned off.

When the power is turned off the effect settings will return to the default settings.

6) TRANSPOSING THE PIANO

The transpose function allows the piano's keys to be raised or lowered in half steps. This is particularly useful when accompanying instruments with different tones, or when a song learned in one key must be played in another key. The transpose feature allows the song to be played in the original key, but heard in another key.

□ Step 1

Press and hold the TRANSPOSE button. While holding the TRANSPOSE button, use the VALUE buttons or the keyboard keys from C3 to C5 to specify the transposition amount.

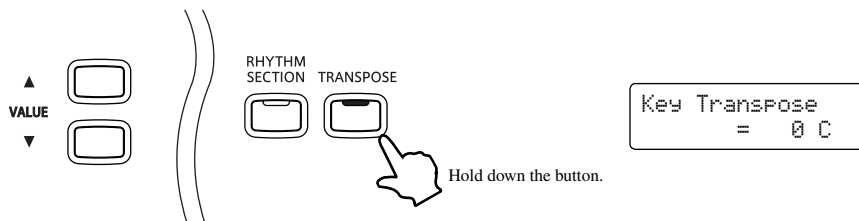

The display will show a number indicating how many half steps up or down the piano has been transposed.

'-5', for example, represents a transposition that is 5 half steps lower.

'0' indicates no transposition.

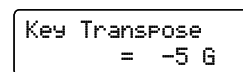

Each time the VALUE ▲ button is pressed, the transpose value is increased by one half step, while each time the VALUE ▼ button is pressed, the transpose value is decreased by one half step.

The piano can be transposed by up to 12 half steps higher or 12 half steps lower.

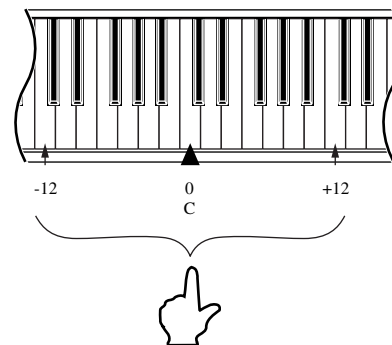
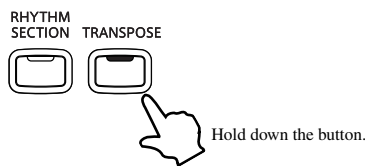

The 'C' key at the middle of the keyboard corresponds to the value 0.

Pressing the TRANSPOSE button again turns the TRANSPOSE function off.

The TRANSPOSE function remembers the current setting as long as the power is on.

- Transpose is active when the LED indicator is on, and the notes are transposed according to the set transpose value. For example if the setting is '-3' and the LED indicator for the TRANSPOSE button is on, the notes will be transposed 3 half steps lower. When the LED indicator for the TRANSPOSE button is turned OFF, the transpose setting will automatically return to '0' (no transposition) with one touch.
- When the value is set to '0', the LED indicator will not turn on.
- The CN43 piano's transpose setting defaults to '0' each time the power is turned on.
- Please refer to page 34 for information regarding the SONG TRANSPOSE function.

7) PLAYING WITH CONCERT MAGIC

The great German composer Johann Sebastian Bach once said *“Playing the keyboard is simple. Just strike the right keys at the right time”*. Many pianists wish it were quite that straightforward. Fortunately, KAWAI have devised a method of playing the keyboard that is very simple, without even needing to strike the right keys.

With CONCERT MAGIC, absolutely anyone can sit at the CN43 piano and make real music - even complete beginners who have never taken a piano lesson in their life. To enjoy performing with Concert Magic, simply select a favorite piece from the 88 pre-programmed songs and tap any key with a steady rhythm and tempo. Concert Magic will provide the correct melody and accompaniment notes, regardless of which keys are pressed. With Concert Magic anybody, young or old, can enjoy playing music from the moment they sit down at the CN43 piano.

◇ SELECTING A SONG

The 88 Concert Magic songs are assigned to each of the 88 keys, and classified by song category into eight groups, such as *Children’s Songs, American Classics, Christmas Songs* etc. Please refer to the separate ‘Concert Magic Song List/Lesson Song List’ booklet for a complete listing of available Concert Magic songs.

□ Step 1

To select a song, press and hold the CONCERT MAGIC button and press the key to which the desired song is assigned.

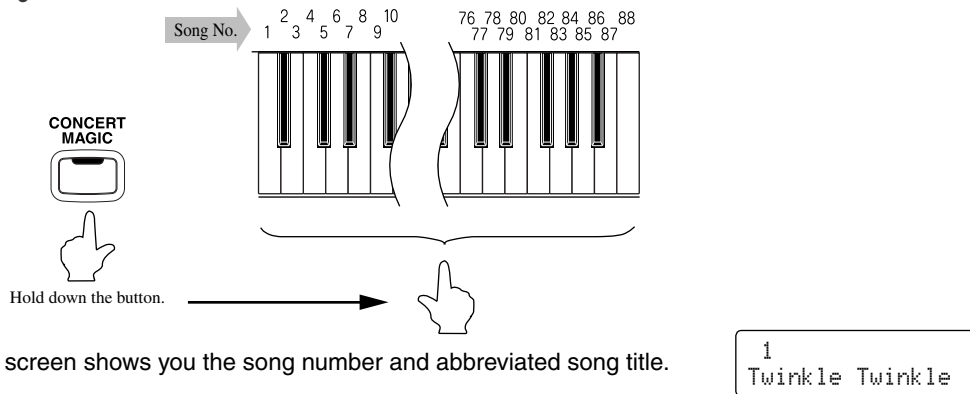

The LCD screen shows you the song number and abbreviated song title.

◇ LISTENING TO THE SONG

If the performer is already familiar with the selected Concert Magic song, he/she may wish to begin playing straight away. However, those unfamiliar with the piece may alternatively wish to listen to the song first, before attempting to play it.

□ Step 1

To listen, press the PLAY/STOP button.

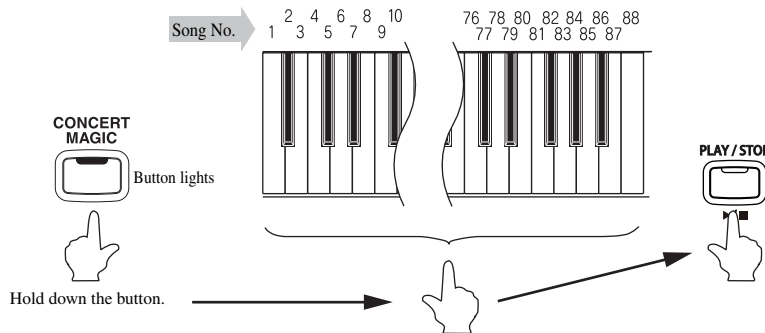

The CN43 piano will start playing back the selected song.

The speed or tempo of the song can be adjusted by pressing and holding the TEMPO button and pressing the VALUE buttons.

While listening, different Concert Magic songs can be selected by pressing the VALUE buttons.

The small circles in the LCD screen will be replaced by plus ('+') signs as the song is played back. These small symbols provide a visual playing guide, indicating when the next key should be pressed. The position and spacing between each circle shown in the LCD screen represents an approximate timing between each key press.

The circles will be replaced by small plus signs as the song is played.

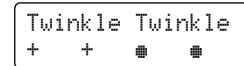

The key to performing using Concert Magic is to become familiar with the rhythm of each song. The approximate outline provided by the Note Navigator, allows the performer to gradually learn the rhythm of each piece.

- To listen to a different song, press and hold the CONCERT MAGIC button and press the key to which the desired song is assigned. Then press the PLAY/STOP button.

□ Step 2

Press the PLAY/STOP button again to finish listening to the song.

◇ PERFORMING A SONG

□ Step 1

Tap out the rhythm of the selected song on any one of the piano's 88 black or white keys.

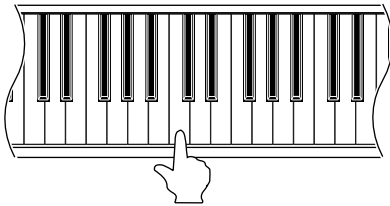

Use the Note Navigator (the circles and plus signs) to learn the rhythm of the Concert Magic song.

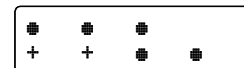

Concert Magic songs will respond to changes in playing style. As the keys are tapped harder, the music will grow louder; if the keys are tapped more softly, the music will become quieter. Tapping faster will cause the music to speed up, while tapping slower will make the music slow down accordingly. Using Concert Magic, even inexperienced pianists can sound like they have been playing for years, simply by pressing one key with one finger.

Concert Magic is a perfect method for small children to learn music, especially when developing a sense of rhythm. For older people who may believe it is too late to learn the piano, Concert Magic offers an enjoyable first step. With Concert Magic, the CN43 piano can be enjoyed by everyone in the family, even those who have never touched a musical instrument in their life.

◇ CONCERT MAGIC PART VOLUME BALANCE

When used with Concert Magic, the BALANCE slider adjusts the volume balance of the melody part and the accompaniment.

□ Step 1

Move the balance slider to the right or left to adjust the volume balance.

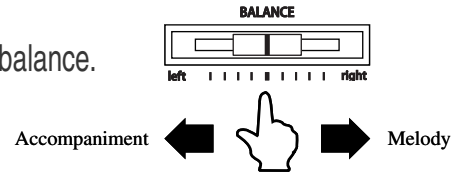

As the slider is moved to the right, the sound of the melody becomes louder and the accompaniment becomes softer. The balance changes in the opposite way when the slider is moved to the left.

◇ CONCERT MAGIC SONG ARRANGEMENT TYPES

After playing with Concert Magic for a while, performers may feel that such playing is too easy and that there is very little to learn. While it is true that some of the songs are very easy to play, even for beginners, there are also some songs which will prove challenging, and require practice to play proficiently.

Each of the 88 Concert Magic songs fall into one of three different arrangement types, depending on the skill level required to perform them.

■ EASY BEAT

These are the easiest songs to play. To perform them, simply tap out a constant steady beat on any key on the keyboard. Look at the following example, 'Für Elise'. The Note Navigator will indicate that a constant, steady rhythm should be maintained throughout the song. This is the distinguishing character of an Easy Beat song.

Press the key with a steady sixteenth note rhythm.

Für Elise
●●●●●●<

Key on X X X X X X X X X X X X X X X X X X X X X X X X

■ MELODY PLAY

These songs are also quite easy to play, especially if they are familiar to the player. To perform them, tap out the rhythm of the melody on any key on the keyboard. Singing along as the rhythm is tapped can be helpful. Play 'Twinkle, Twinkle, Little Star' for example. Follow the melody's rhythm as shown.

Key on X X X X X X X X X X X X X X

When performing fast songs with Concert Magic, it is sometimes easier to tap two different keys with two alternating fingers in order to play at greater speed.

■ SKILLFUL

These songs range in difficulty from moderately difficult to difficult. To perform them, tap out the rhythm of both the melody and the accompaniment notes on any key on the keyboard, such as 'Waltz of the Flowers' shown below. The Note Navigator will be very helpful with the Skillful songs.

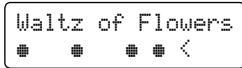

Key on X X X X X X X X X X X X X

It may take a little practice to perform the Concert Magic songs proficiently. A good way to learn is to listen to these pieces first, and then try to tap out the rhythms that are heard.

- The separate 'Concert Song List/Lesson Song List' booklet lists the arrangement type next to each song title as 'EB' for Easy Beat, 'MP' for Melody Play and 'SK' for Skillful.

◇ STEADY BEAT

Steady Beat allows Concert Magic songs to be played by simply tapping any key with a constant steady beat, regardless of the song arrangement type.

□ Step 1

Press and hold the CONCERT MAGIC button.

The current Concert Magic mode will be shown on the second line of the LCD screen.

The default Concert Magic mode is NORMAL.

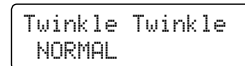

□ Step 2

While still holding the CONCERT MAGIC button, use the VALUE button to change the Concert Magic mode to STEADY BEAT.

Hold down the button.

The Concert Magic mode will change to STEADY BEAT.

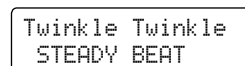

□ Step 3

Start by tapping any key with a constant steady beat.

The tapping speed will set the tempo for the song. Both the accompaniment and melody parts will be played automatically in time with the tapped tempo.

◇ CONCERT MAGIC DEMO MODES

There are three ways to listen to the Concert Magic songs in the DEMO mode.

◆ ALL PLAY

Press the CONCERT MAGIC button and then press the PLAY/STOP button without selecting a song. The CN43 piano will play back all of the Concert Magic songs in order.

◆ RANDOM PLAY

Press the CONCERT MAGIC button and then press the LESSON button. The CN43 piano will play back all of the Concert Magic songs in random order.

◆ CATEGORY PLAY

Press and hold the CONCERT MAGIC and LESSON buttons and press the piano key to which the desired song is assigned. The CN43 piano will play back the selected song and then continue to play the rest of the songs in the same category.

To stop the demo, press the PLAY/STOP button.

◇ CONCERT MAGIC PLAYBACK SPEED

The TEMPO button is also used to adjust the playback speed of Concert Magic songs.

□ Step 1

After selecting a Concert Magic song to play back, press and hold the TEMPO button.

The tempo value will be shown in the LCD screen.

□ Step 2

While holding down the TEMPO button, use the VALUE buttons to change the tempo.

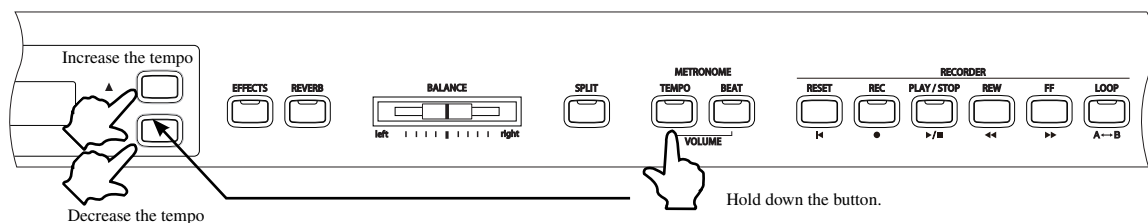

The tempo of the selected Concert Magic song can be adjusted either before playback, or while the song is playing.

8) METRONOME

Rhythm is one of the most important elements when learning music. It is important to practice playing the piano at the correct tempo and with a steady rhythm. The CN43 piano's metronome tool helps learners to achieve this by providing a steady beat to play along with.

◇ STARTING THE METRONOME

- Step 1
Press the TEMPO button.

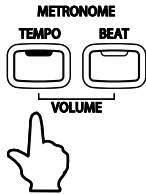

The LED indicator for the TEMPO button will turn on and the metronome will begin counting with a steady beat. The tempo in beats per minute will be shown in the LCD screen.

Tempo ♩ = 120
#000

- Step 2
Press the VALUE buttons to increase or decrease the tempo within the range of 10 - 400 beats per minute. (20-800 BPM with eighth note rhythms).



- Step 3
Press the TEMPO button again to stop the metronome.

◇ CHANGING THE TIME SIGNATURE

The metronome produces two types of click, with the louder click heard on every fourth beat - this is a 4-beat or 4/4 time signature.

The metronome is capable of providing a down beat to indicate the beginning of the measure.

It is possible to select a different signature where appropriate. There are ten different times signatures available on the CN43 piano: 1/4, 2/4, 3/4, 4/4, 5/4, 3/8, 6/8, 7/8, 9/8 and 12/8.

- Step 1
Press the BEAT button.

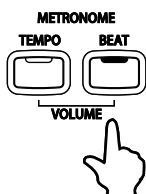

The LED indicator for the BEAT button will turn on and the metronome will begin counting. The currently selected time signature and a visual indicator of each beat will be shown in the LCD screen.

Beat = 4/4
#000

□ Step 2

Press the VALUE buttons to select the desired time signature.



The currently selected time signature or rhythm will be shown in the LCD screen.

□ Step 3

Press the BEAT button again to stop the metronome.

Both the TEMPO button and the BEAT button can be used to turn the metronome on and off, depending on whether the tempo or time signature is being adjusted.

◇ ADJUSTING THE METRONOME VOLUME

The volume level of the metronome can also be adjusted.

□ Step 1

Press the TEMPO and BEAT buttons simultaneously.

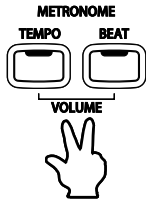

The volume level of the metronome will be shown in the LCD screen, represented by numbers ranging from 1 (soft) to 10 (loud). The default metronome volume level is 5.

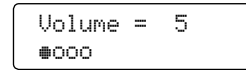

□ Step 2

Press the VALUE buttons to increase or decrease the volume level of the metronome.



□ Step 3

Press the TEMPO and BEAT buttons simultaneously again to stop the metronome.

9) PANEL LOCK

The Panel Lock function allows the state of all panel buttons to be temporarily locked, preventing sounds and other settings from being changed accidentally while playing the piano.

□ Step 1

Press the CONCERT MAGIC and TRANSPOSE buttons simultaneously.

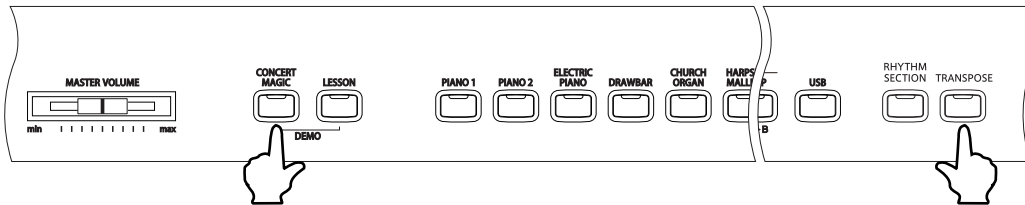

The CN43 control panel will stop responding to button pushes.

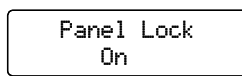

'Panel Lock On' will be shown in the LCD screen.

□ Step 2

Press the CONCERT MAGIC and TRANSPOSE buttons simultaneously again to deactivate the panel lock.

The CN43 control panel will return to normal operation.

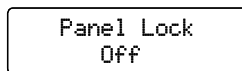

'Panel Lock Off' will be shown in the LCD screen.

- When the power is turned off, the Panel Lock function will be released.

3. LESSON FUNCTION

The CN43's Lesson function helps performers to practice the piano with a collection of etudes from Czerny, Burgmüller and Beyer, or songs from *Alfred's Basic Piano Library* and *Alfred's Premier Piano Course* lesson books (USA, Canada, Australia and UK only). It is possible to listen to each etude or song at various tempos, practicing the left and right hand parts separately, before eventually recording a practice session for self-evaluation.

Alfred's Basic Piano Library and *Alfred's Premier Piano Course* lesson books are sold separately. Please check with local dealers or contact Alfred's customer service by telephoning 818-892-2452 (USA & Canada), 0-95240033 (Australia), +44 (0)1279828960 (UK). Or alternatively, by e-mailing customerservice@alfred.com.

1) SELECTING A BOOK/SONG

□ Step 1

Press the LESSON button.

The LED indicator for the LESSON button will turn on to indicate that lesson mode is enabled.

The currently selected book name will be shown in the LCD screen.

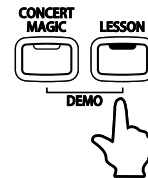

```
AlfredChild1A-01
Bar= 0- 1 ♯=100
```

Lesson availability differs according to geographical location:

	Lesson Book Name
US, Canada, UK, Australia	Alfred's Premier Piano Course Lesson 1A
	Alfred's Premier Piano Course Lesson 1B
	Alfred's Basic Piano Library Lesson Book Level 1A
	Alfred's Basic Piano Library Lesson Book Level 1B
	Alfred's Basic Piano Library Lesson Book Level Adult
Rest of the World	Burgmüller 25 (25 Etudes Faciles, Opus 100)
	Czerny 30 (Etudes de Mécanisme, Opus 849)
	Czerny 100 (Hundert Übungsstücke, Opus 139)
	Beyer (Vorschule im Klavierspiel, Opus 101)

□ Step 2

Press the MENU buttons to change the selected lesson book type.

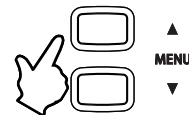

□ Step 3

Press the VALUE buttons to change the selected lesson song.



It is also possible to select a song directly by holding down the LESSON button and pressing a key on the keyboard. Please refer to the separate 'Concert Magic Song List/Lesson Song List' booklet for a complete listing of available lesson songs.

```
AlfredChild1A-01
Bar= 0- 1 ♯=100
```

2) LISTENING TO AND PLAYING A SONG

□ Step 1

Press the PLAY/STOP button to play the selected song.

There will be a one bar count-in before the song starts to play.

Press the PLAY/STOP button to stop the song.

Press the REW button to rewind the song and the FF button to fast forward the song. The bar number and beat number will be shown in the LCD screen. Press the RESET button to return to the beginning of the song.

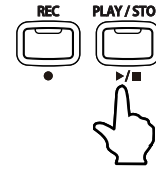

◆ A-B LOOP

The A-B Loop function allows a specific part of a song to be played back repeatedly. While playing back a song, press the LOOP button at the desired loop start point (point A), then press the LOOP button again at the desired loop end point (point B). The recorder will playback the song between point A and point B repeatedly until the PLAY/STOP button is pressed.

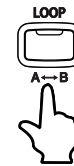

■ DUAL or SPLIT sounds cannot be selected in LESSON mode.

◇ EXITING THE LESSON FUNCTION

□ Step 1

Press the LESSON button.

The LED indicator for the LESSON button will turn off, and the unit returns to the normal operation mode.

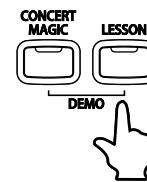

◇ PRACTICING THE LEFT AND RIGHT-HAND PARTS

The volume balance of the left and right-hand parts can be adjusted using the BALANCE slider.

□ Step 1

After selecting a song, move the BALANCE slider to the left or to the right.

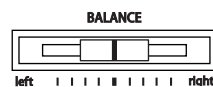

Decreases the volume of the right-hand part



Decreases the volume of the left-hand part

Moving the balance slider partially to the left will gradually decrease the volume of the right-hand part, allowing the right-hand part to be practiced while the pre-recorded part plays softly as a guide. When the balance slider is moved fully to the left, the pre-recorded right-hand part will be muted completely.

◇ ADJUSTING THE TEMPO OF A SONG

□ Step 1

Press and hold the TEMPO button and press the VALUE ▲ or ▼ buttons to increase or decrease the tempo of the song.

3) RECORDING A SONG PRACTICE

Listening to recorded lesson song practice provides an excellent tool for self-evaluation.

□ Step 1

Press the REC button.

The LED indicator for the REC button will start to flash to indicate that the CN43 piano is ready to record.

Recording information will be shown in the LCD screen, as below.

```
Record
Bar= 0- 2 1=100
```

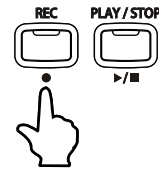

□ Step 2

Press the PLAY/STOP button.

There will be a one bar count-in before the recording starts.

```
Recording
Bar= 4- 2 4=100
```

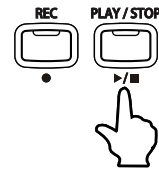

It is recommended to turn on the metronome when recording.

□ Step 3

Press the PLAY/STOP button to stop recording the lesson practice.

◇ PLAYING BACK THE RECORDING

□ Step 1

Press the PLAY/STOP button to listen to the recording.

The performance that has been recorded will be played. The left and right-hand playing volume can be changed using the BALANCE slider.

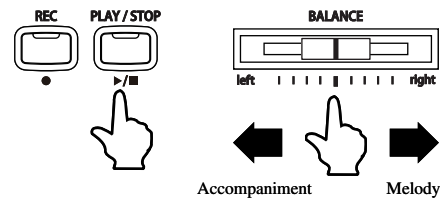

◇ ERASING THE RECORDING

□ Step 1

Press the PLAY/STOP and REC buttons simultaneously to erase the recording.

- Recordings made while using the Lesson Function cannot be saved and are intended for temporary reference only. When changing to another song, exiting the Lesson Function or turning off the CN43 power, Lesson recordings will be erased.
- Preset Lesson songs cannot be permanently overwritten or erased.

4. INTERNAL RECORDER

The RECORDER function records performances in a similar way to that of a tape recorder. However, the CN43 piano records songs as digital data, instead of audio data - storing the music inside the instrument. Because each song is stored digitally, it is possible to modify various aspects during playback, such as adjusting the tempo without changing the pitch, or selecting different sound types and effects settings. Once fully understood, the recorder function provides an easy to use tool for both practicing and playing the piano.

1) RECORDING (REC BUTTON)

The CN43 allows up to three different songs to be recorded, stored in memory, and played back at the touch of a button. Each song has two separate tracks called 'Parts' that can be recorded independently. This allows the left-hand part to be recorded first on one track, then the right-hand part to be recorded later on the other track, while listening to the first part.

When recording or playing back a song, each part (track) can be re-recorded or played back freely. Attempting to re-record a part will automatically erase all previously recorded performance information for that part, therefore when recording parts separately, it is most important to select the correct part carefully, in order to prevent accidentally overwriting a previously recorded part.

- Step 1
Press the REC button.

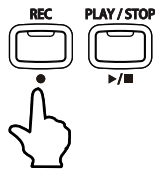

Song, part number, bar and tempo information will be shown in the LCD screen.

```
Song1 Part=1
Record    ♪=120
```

To record a song without making any changes, proceed to step 4.

- If a USB memory device is connected, a selection screen will be shown in the LCD display.
Press the VALUE ▲ button to select the Internal Recorder function.
For more information about the USB Recorder function, please refer to page 36.

- Step 2
Press the MENU buttons to select the song (1,2 or 3) to be recorded.

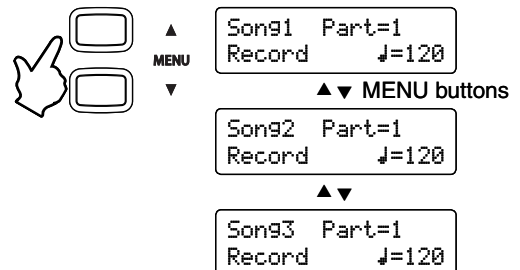

- Step 3
Press the VALUE buttons to select the part number (1 or 2) to be recorded.

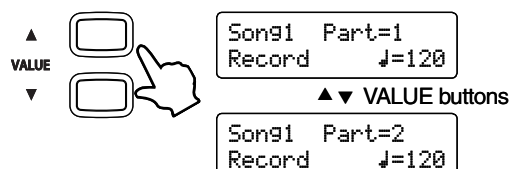

- Step 4
Start to play the piano.

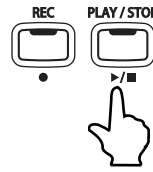
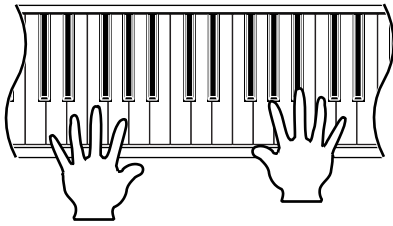

The recorder will automatically start recording with the first note played. During this time, the LED indicators for the REC and PLAY/STOP buttons will be turned on. Any changes made to the sound while recording will also be recorded. The recording can be started by pressing the PLAY/STOP button instead of pressing a key, allowing a blank bar to be inserted at the beginning of a song.

- Step 5
Press the PLAY/STOP button to stop recording.

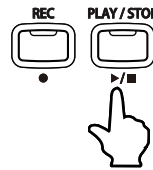

The LED indicators for the PLAY/STOP button and the REC button will turn off and the newly recorded part will be saved to memory automatically.

Saving may take a few moments and during this time the piano will not perform any other operations.

To record the piece again, simply repeat the above procedure. The new recording will completely erase the previous one.

- The total recording capacity of the CN43 piano's memory is approximately 15,000 notes, with button and pedal presses also counted as one note.
 - When the maximum capacity is reached, recording will stop and all music recorded up until that point will be saved to memory automatically.
- Performance data stored inside the CN43 piano's memory will be saved even after turning off the power.
- Panel operations stored during recording:
 - Changes made to the sound type.
 - Shifts between DUAL and SPLIT modes.
- Panel operations NOT stored during recording:
 - Changes made to effect settings – the selected effect will be applied to the selected sound type.
 - Changes made to tempo.
 - Changes made using the BALANCE slider in DUAL or SPLIT modes – the volume balance set immediately before recording will be stored, however.
 - Turning the TOUCH CURVE or TRANSPOSE functions ON or OFF – regardless of the transpose settings the performance will be replayed at the pitch originally used for the recording.

2) PLAYING BACK A SONG

The PLAY/STOP button is used to start and stop playback of the recorded song, and to also select which song and part is played.

□ Step 1

Press the PLAY / STOP button.

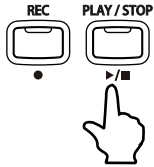

The currently selected song and parts will be shown in the LCD screen, and the CN43 piano is ready to playback the song.

```
Song91 Part=1&2*
Bar= 1- 1 ♪=120
```

□ Step 2

Press the MENU buttons to select a song.

An asterisk indicates that the part has been recorded.

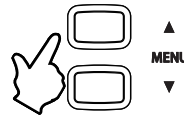

```
Song93 Part=2*
Bar= 1- 1 ♪=120
```

□ Step 3

Press the VALUE buttons to select a part.

Part 1 & 2 : Both parts will be played back.

Part 1 : Only Part 1 will be played back.

Part 2 : Only Part 2 will be played back.



□ Step 4

Press the PLAY/STOP button again and the recorded song will start to play.

Playback information will be shown in the LCD screen.

```
Playing
Bar= 2- 1 ♪=120
```

□ Step 5

Press the PLAY/STOP button again to stop playback and return to the song select display.

Press the REW button to rewind the song and the FF button to fast forward the song. The bar number and beat number will be shown in the display. Press the RESET button to return to the beginning of the song.

- While the song is being played, performance information is also sent to supported devices as MIDI data (See page 87). PART1 is sent on 1ch and PART2 is sent on 2ch. When recording in DUAL mode, additional information for PART1 is sent on 9ch and additional information for PART2 is sent on 10ch.

3) TRANSPOSING A SONG

This function allows the currently selected song and songs loaded from a USB device to be transposed.

□ Step 1

Press and hold the TRANSPOSE button, then press the MENU buttons to select the Song Transpose function.

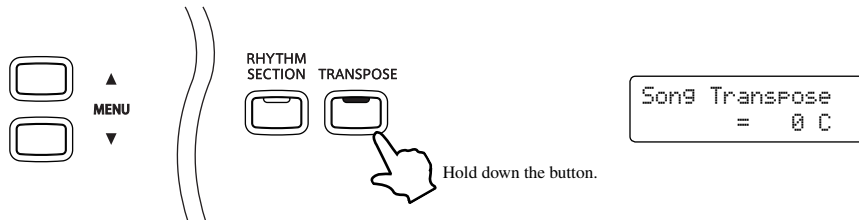

'Song Transpose' and a value of '0 C' will be shown in the LCD screen, indicating that the song is in its original key and has not been transposed.

□ Step 2

Press and hold the TRANSPOSE button, then press the VALUE buttons to specify the transposition amount.

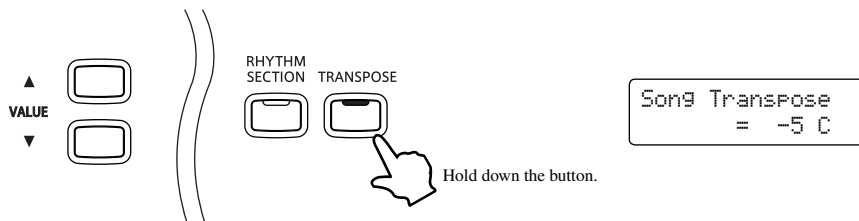

The LCD screen will show a number indicating how many half steps up or down the current song has been transposed.

'-5', for example, represents a transposition that is 5 half steps lower.

- The piano can be transposed by up to 12 half steps higher or 12 half steps lower.
- When a different song is selected, the song transposition value will reset to '0 C'.

4) ERASING A SONG

This function allows any songs that are no longer listened to, to be cleared.

□ Step 1

Press the PLAY/STOP and REC buttons simultaneously.

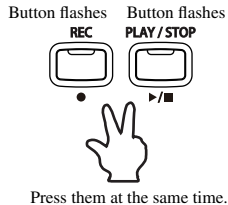

Press them at the same time.

The LED indicators for the PLAY/STOP and REC buttons will start to flash, and song erase information will be shown in the LCD screen.

```
To Del Press REC
Song 1 Part=1&2*
```

□ Step 2

Use the MENU buttons to select a song, then use the VALUE buttons to select a part.



□ Step 3

Press the REC button to erase the selected song and part. A confirmation message will be shown in the LCD screen.

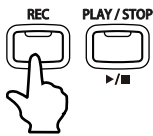

```
Sure? Press REC
Song 1 Part=1&2*
```

□ Step 4

Press the REC button again to confirm erasing the selected song and part.

```
Deleting
Song 1 Part=1&2*
```

* To cancel the erase operation in Step 3, press the PLAY/STOP button.

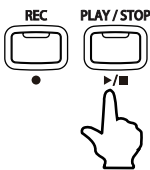

- Repeat the steps above in order to erase a number of songs and parts.
- To erase all songs from memory at once, first turn off the power and then turn it on again, holding down both the REC button and the PLAY/STOP button.

5. USB RECORDER

The CN43's USB Recorder allows the recording and playback of MP3 and WAV audio files and 16 track Standard MIDI File (SMF) format songs directly to/from USB memory devices.

 Do not attempt to disconnect USB devices while they are being accessed. Doing so may result in data loss or permanent damage

1) RECORDING AN AUDIO FILE

This useful function allows professional quality MP3 and WAV audio recordings to be produced directly on the instrument without the need for additional sound equipment. Once saved, the audio files can be emailed to friends and family, played back through an iPod, or edited and remixed further using an audio workstation.

■ Audio Recorder format specifications

Audio Format	Specifications	Bitrate
MP3	44.1 kHz, 16 bit, Stereo	192 kbit/s (fixed)
WAV	44.1 kHz, 16 bit, Stereo	1,411 kbit/s (uncompressed)

MPEG Layer-3 audio coding technology licensed from Fraunhofer IIS and Thomson.
MP3 codec is Copyright (c) 1995-2007, SPIRIT

◇ SELECTING THE USB RECORDER AND AUDIO FORMAT

□ Step 1

Connect a USB memory device, then press the REC button.

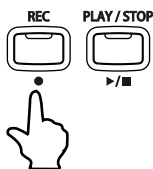

The Internal Recorder / USB Recorder selection screen will be shown in the LCD display.

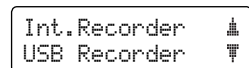

■ The USB Recorder can also be accessed via the USB Menu (page 48).

□ Step 2

Press the VALUE ▼ button to select the USB Recorder function.

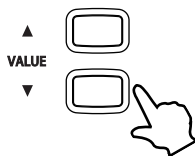

The LED indicator for the USB button will turn on, and the USB Recorder format selection screen will be shown in the LCD display.

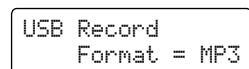

Press the VALUE buttons to select either WAV or MP3 audio file formats.

- MP3 audio files require less storage space than WAV audio files.
- A 1GB USB memory device can store over 12 hours of MP3 audio data.

□ Step 3

Press the REC button.

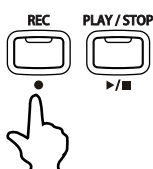

The LED indicator for the REC button will start to flash to indicate that the recorder is in standby mode.

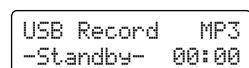

A recording timer will be shown in the LCD display

◇ STARTING THE RECORDER

- Step 4
Press a key on the keyboard.

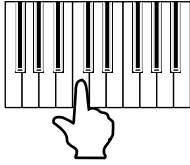

The LED indicators for the REC and PLAY/STOP buttons will turn on, and recording will start.

```
USB Record  MP3
Recording  00:24
```

- Recording can also be started by pressing the PLAY/STOP button, allowing a rest period to be inserted at the beginning of the audio file.

- Step 5
Press the PLAY/STOP button.

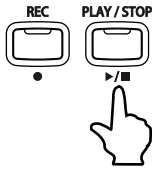

The LED indicators for the PLAY/STOP and REC buttons will turn off, and recording will stop.

```
Save to USB?
Yes+REC No+STOP
```

A confirmation message will be shown in the LCD screen, prompting to save the recorded audio file.

◇ SAVING THE RECORDED AUDIO FILE

- Step 6
Press the REC button to save the recorded audio file to the USB memory device.

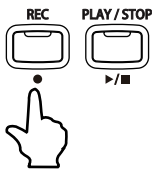

The filename entry screen will be shown in the LCD display.

```
Song name:
MP3 Song 01 +REC
```

- To cancel saving the recorded audio file and exit the USB Recorder, press the PLAY/STOP button.

- Step 7
Press the MENU and VALUE buttons to enter a name for the recorded audio file.

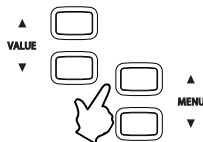

Press the VALUE buttons to select the character.
Press the MENU buttons to move the cursor.

```
Song name:
FunkIdea2 +REC
```

- New files are limited to a maximum name length of 12 characters.
- 'MP3 Song 01' or 'WAV Song 01' will be used as the default name for the recorded audio files. The number will increase automatically with each recording.

- Step 8
Press the REC button again to save the recorded audio file to the USB memory device.

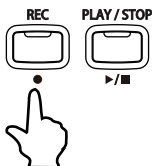

A confirmation message will be shown in the LCD display to indicate that the recorded audio file has been saved.

```
Saving...
```

After saving, the audio file will automatically be selected for playback (page 39).

```
Complete!
```

- The saved audio file will be stored in the root folder of the USB device. It is not possible to store the file in a different folder.
- The audio recorder records sounds produced by the instrument only. Devices connected to the LINE IN jacks will not be recorded.
- If the specified name already exists, an overwrite confirmation message will be shown in the LCD screen prompting to confirm or cancel the save operation.

```
FunkIdea2
Vol.040 00:00
```

2) PLAYING AN AUDIO FILE

The CN43 is also capable of playing MP3 and WAV audio files stored on a USB memory device directly through the instrument's speaker system. This function is particularly useful when attempting to learn the chords or melody to a new piece, or to simply play along with one's favorite song.

■ Audio Player supported format specifications

Audio Format	Specifications	Bitrate
MP3	32 kHz/44.1 kHz/48 kHz, Mono/Stereo	8-320 kbit/s (fixed & variable)
WAV	32 kHz/44.1 kHz/48 kHz, Mono/Stereo, 8 bit/16 bit	-

MPEG Layer-3 audio coding technology licensed from Fraunhofer IIS and Thomson.
MP3 codec is Copyright (c) 1995-2007, SPIRIT

■ Preparing the USB memory device

First, prepare a selection of MP3 or WAV audio files, copying the data to a USB memory device.

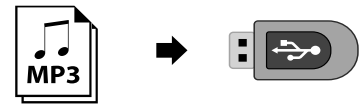

- USB devices should be formatted to use the 'FAT' or 'FAT32' filesystems.

◇ SELECTING THE USB RECORDER AND AUDIO FILE

□ Step 1

Connect a USB device, then press the PLAY/STOP button.

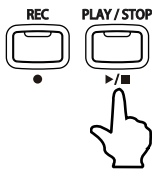

The Internal Recorder / USB Recorder selection screen will be shown in the LCD display.

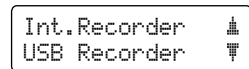

- The USB Recorder can also be accessed via the USB Menu (page 48).

□ Step 2

Press the VALUE ▼ button to select the USB Recorder function.

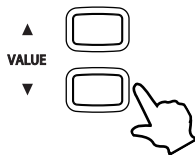

The LED indicator for the USB button will turn on, and a list of the media files stored in the root folder of the USB memory device will be shown in the LCD display.

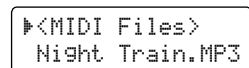

The < > symbols are used to indicate a folder.
The selection cursor is represented by a ► symbol.

□ Step 3

Press the MENU and VALUE buttons to select the desired audio file.

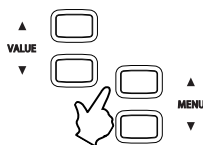

Press the MENU buttons to scroll through the files/folders.
Press the VALUE buttons to select the file/folders.

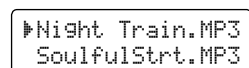

- Select the <DIR UP> entry to return to the previous folder.

After a short delay, the play screen will be shown in the LCD display.

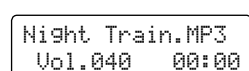

◇ PLAYING THE SELECTED AUDIO FILE

- Step 4
Press the PLAY/STOP button.

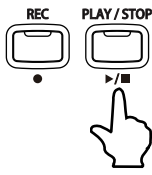

The LED indicator for the PLAY/STOP button will turn on, and the selected audio file will begin to play.

```
Playing
Vol.040 00:24
```

During playback, press the FF or REW buttons to fast-forward or rewind the audio file.

◇ ADJUSTING THE PLAYBACK VOLUME

- Step 5
During playback, press the VALUE buttons.

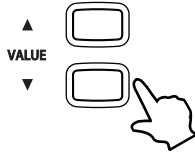

The playback volume will increase or decrease.

```
Playing
Vol.057 00:45
```

- The volume level of USB Recorder songs can be adjusted within the range 0 to 100.

◇ REPEATING A PHRASE (A-B LOOP)

The A-B Loop function allows a specific part of a song to be played back repeatedly.

- Step 6
During playback, press the A-B Loop button to set the start and end points of the loop.



Press the A-B button once to set the desired start point (A), then once again to set the end point (B) of the loop.

The song will play between points A and B continuously until the song is stopped or the A-B button is pressed to cancel the loop.

◇ STOPPING AUDIO FILE PLAYBACK

- Step 7
Press the PLAY/STOP button.

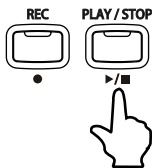

The LED indicator for the PLAY/STOP button will turn off, and the selected audio file will stop playing temporarily.

Press the PLAY/STOP button once again to continue playback, or the RESET button to reset the playback position to the beginning.

When audio playback has been stopped, press the MENU buttons to return to the file selection screen, or the USB button to exit the recorder.

3) RECORDING AN SMF SONG

This useful function allows 16 track SMF (Standard MIDI File) format songs to be recorded directly on the instrument, or for existing song files to be edited/modified without the need for additional sound equipment.

◇ SELECTING THE USB RECORDER

- Step 1
Connect a USB memory device, then press the REC button.

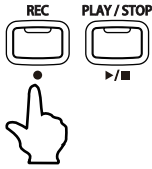

The Internal Recorder / USB Recorder selection screen will be shown in the LCD display.

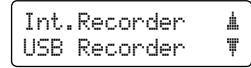

- The USB Recorder can also be accessed via the USB Menu (page 48).

- Step 2
Press the VALUE ▼ button to select the USB Recorder function.

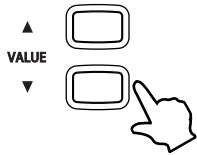

The LED indicator for the USB button will turn on, and the USB Recorder format selection screen will be shown in the LCD display.

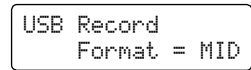

Press the VALUE buttons to select the MID format.

- Step 3
Press the REC button.

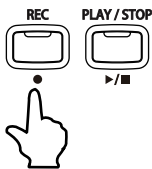

The LED indicator for the REC button will start to flash to indicate that the recorder is in standby mode.

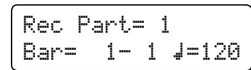

The Recorder screen will be shown in the LCD display.

◇ SELECTING THE PART (TRACK) TO RECORD

- Step 4
Press the VALUE buttons to select the Part (track) to be recorded.

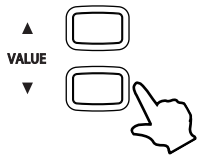

- Part 10 is reserved as a drum track. When selecting Part 10, only drum sounds can be played. Similarly, drum sounds can only be played on Part 10.
- When the Rec Part is set to MIDI, all data received from the MIDI IN jack will be recorded on Parts 1-16, according to the MIDI channel.

◇ STARTING THE RECORDER

- Step 5
Press a key on the keyboard.

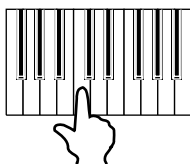

The LED indicators for the REC and PLAY/STOP buttons will turn on, and recording will start on the selected track.

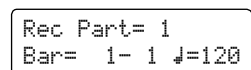

- Recording can also be started by pressing the PLAY/STOP button, allowing a rest period to be inserted at the beginning of the SMF file.

- Step 6
Press the PLAY/STOP button.

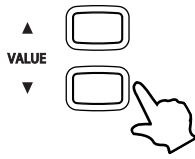

The LED indicators for the PLAY/STOP and REC buttons will turn off, and recording will stop.

```
Rec Part= 1*
Bar= 1- 1 ↓=120
```

An asterisk (*) symbol will be shown beside the part number to indicate that the part has been recording and contains song data.

To record another part (track), first press the REC button, then repeat steps 4 and 5.

◇ SAVING THE RECORDED SMF FILE

When pressing the MENU buttons to select another song, or pressing the USB button to exit the USB Recorder, a save prompt will be shown in the LCD screen.

- Step 7
Press the MENU buttons or USB button.



A confirmation message will be shown in the LCD screen, prompting to save the recorded SMF file.

```
Save to USB?
Yes→REC No→STOP
```

- Step 7
Press the REC button to save the recorded SMF file to the USB memory device.

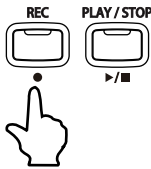

The filename entry screen will be shown in the LCD display.

```
Song name:
SMF Song 01 →REC
```

- To cancel saving the recorded SMF file and return to the recorder, press the PLAY/STOP button.

- Step 7
Press the MENU and VALUE buttons to enter a name for the recorded SMF file.

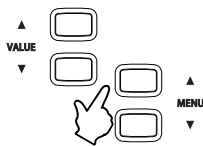

Press the VALUE buttons to select the character.
Press the MENU buttons to move the cursor.

```
Song name:
BigSwing02 →REC
```

- Saved files are limited to a maximum name length of 12 characters.
- 'SMF Song 01' will be used as the default name for the recorded SMF file. The number will increase automatically with each recording.

- Step 8
Press the REC button again to save the recorded SMF file to the USB memory device.

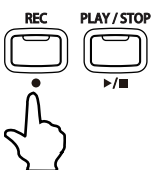

A confirmation message will be shown in the LCD display to indicate that the SMF file has been saved.

```
Saving...
```



```
Complete!
```

- The saved SMF file will be stored in the root folder of the USB device. It is not possible to store the file in a different folder.
- If the specified name already exists, an overwrite confirmation message will be shown in the LCD screen prompting to confirm or cancel the save operation.

4) PLAYING AN SMF SONG

This function allows 16 track SMF (Standard MIDI File) format songs stored on USB memory devices to be played directly on the instrument.

■ Preparing the USB memory device

First, prepare a selection of SMF (MID) song files, copying the data to a USB memory device.

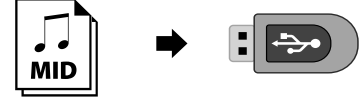

- USB devices should be formatted to use the 'FAT' or 'FAT32' filesystems.

◇ SELECTING THE USB RECORDER

□ Step 1

Connect a USB device, then press the PLAY/STOP button.

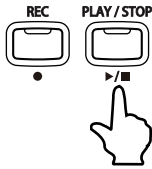

The Internal Recorder / USB Recorder selection screen will be shown in the LCD display.

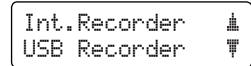

- The USB Recorder can also be accessed via the USB Menu (page 48).

□ Step 2

Press the VALUE ▼ button to select the USB Recorder function.

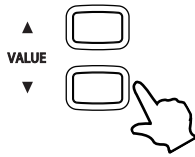

The LED indicator for the USB button will turn on, and a list of the media files stored in the root folder of the USB memory device will be shown in the LCD display.

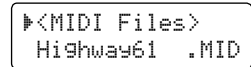

The < > symbols are used to indicate a folder. The selection cursor is represented by a ► symbol.

□ Step 3

Press the MENU and VALUE buttons to select the desired SMF file.

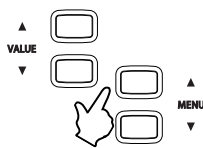

Press the MENU buttons to scroll through the files/folders. Press the VALUE buttons to select the file/folders.

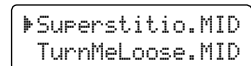

- Select the <DIR UP> entry to return to the previous folder.

After a short delay, the play screen will be shown in the LCD display.

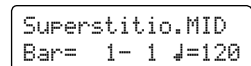

◇ PLAYING THE SELECTED SMF FILE

□ Step 4

Press the PLAY/STOP button.

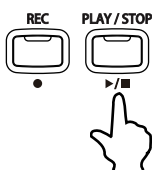

The LED indicator for the PLAY/STOP button will turn on, and the selected SMF file will begin to play.

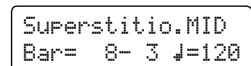

During playback, press the FF and REW buttons to fast-forward and rewind the audio file,

◇ ADJUSTING THE PLAYBACK VOLUME & TEMPO

□ Step 5
Press and hold the USB button, then press the VALUE buttons.

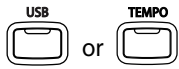

The current playback volume will be shown in the LCD display and the volume level will increase or decrease.



■ The volume level of USB Recorder songs can be adjusted within the range 0 to 100.

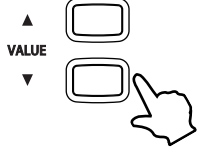

To adjust the tempo of the song playback, press and hold the TEMPO button, then press the VALUE buttons.

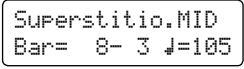

■ The tempo of SMF songs can be adjusted within the range of 10 - 400 beats per minute.

◇ REPEATING A PHRASE (A-B LOOP)

The A-B Loop function allows a specific part of a song to be played back repeatedly.

□ Step 6
Press the A-B Loop button to set the start and end points of the loop.



Press the A-B button once to set the desired start point (A), then once again to set the end point (B) of the loop.

The song will play between points A and B continuously until the song is stopped or the A-B button is pressed to cancel the loop.

◇ MUTING A PART (TRACK)

This function allows each of the 16 parts (tracks) of the SMF song to be individually muted or played.

□ Step 7
Press one of the VALUE buttons.

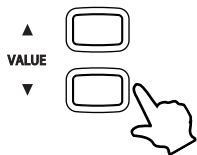

The 16 parts (tracks) of the SMF song will be shown in the LCD display.

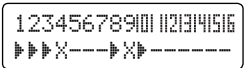

□ Step 8
Press the MENU and VALUE buttons to select and mute/play each part (track).

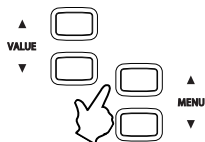

Press the VALUE buttons to mute/play the part (track). Press the MENU buttons to move the selection cursor.

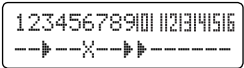

A ▶ symbol is used to indicate a playing part.
An X symbol is used to indicate a muted part.
An – symbol is used to indicate an empty part.

◇ STOPPING SMF SONG PLAYBACK

- Step 7
Press the PLAY/STOP button.

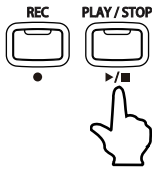

The LED indicator for the PLAY/STOP button will turn off, and the selected SMF file will stop playing temporarily.

Press the PLAY/STOP button once again to continue playback, or the RESET button to reset the playback position to the beginning.

Once song playback has stopped, press the MENU buttons to return to the file selection screen, or the USB button to exit the recorder.

5) RECORDING TO AN EXISTING SMF SONG

This function allows any of the 16 parts (tracks) of the SMF song to be re-recorded.

First follow 'Playing an SMF Song' steps 1-3 to select the desired SMF song, then proceed from step 4 below.

- Step 4
Press the REC button.

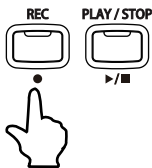

The LED indicator for the REC button will start to flash to indicate that the recorder is in standby mode.

```
Rec Part= 1
Bar= 1- 1 ↓=100
```

The SMF Recorder screen will be shown in the LCD display.

◇ SELECTING THE PART (TRACK) TO RECORD

- Step 5
Press the VALUE buttons to select the Part (track) to be recorded.

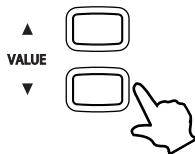

- Part 10 is reserved as a drum track. When selecting Part 10, only drum sounds can be played. Similarly, drum sounds can only be played on Part 10.
- When the Rec Part is set to MIDI, all data received from the MIDI IN jack will be recorded on Parts 1-16, according to the MIDI channel.

◇ STARTING THE RECORDER

- Step 6
Press a key on the keyboard.

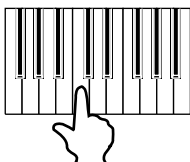

The LED indicators for the REC and PLAY/STOP buttons will turn on, and recording will start on the selected track.

```
Rec Part= 1
Bar= 1- 1 ↓=100
```

- Recording can also be started by pressing the PLAY/STOP button, allowing a rest period to be inserted at the beginning of the SMF file.

- Step 7
Press the PLAY/STOP button.

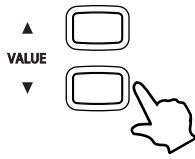

The LED indicators for the PLAY/STOP and REC buttons will turn off, and recording will stop.

```
Rec Part= 1*
Bar= 1- 1 ▾=100
```

An asterisk (*) symbol will be shown beside the part number to indicate that the part has been recording and contains song data.

To record another part (track), first press the REC button, then repeat steps 4 and 5.

◇ SAVING THE RECORDED SMF FILE

When pressing the MENU buttons to select another song, or pressing the USB button to exit the USB Recorder, a save prompt will be shown in the LCD screen.

- Step 8
Press the MENU buttons or USB button.



A confirmation message will be shown in the LCD screen, prompting to save the recorded SMF file.

```
Save to USB?
Yes→REC No→STOP
```

- Step 9
Press the REC button to save the recorded SMF file to the USB memory device.

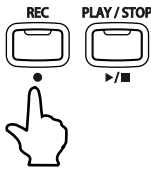

The filename entry screen will be shown in the LCD display.

```
Song name:
SMF Song 01 →REC
```

- To cancel saving the recorded SMF file and return to the recorder, press the PLAY/STOP button.

- Step 10
Press the MENU and VALUE buttons to enter a name for the recorded SMF file.

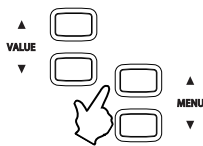

Press the VALUE buttons to select the character.
Press the MENU buttons to move the cursor.

```
Song name:
BigSwing02 →REC
```

- Saved files are limited to a maximum name length of 12 characters.
- 'SMF Song 01' will be used as the default name for the recorded SMF file. The number will increase automatically with each recording.

- Step 11
Press the REC button again to save the recorded SMF file to the USB memory device.

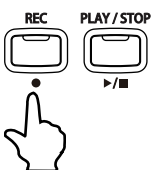

A confirmation message will be shown in the LCD display to indicate that the SMF file has been saved.

```
Saving...
```



```
Complete!
```

- The saved SMF file will be stored in the root folder of the USB device. It is not possible to store the file in a different folder.
- If the specified name already exists, an overwrite confirmation message will be shown in the LCD screen prompting to confirm or cancel the save operation.

6) CONVERTING A SONG TO AN AUDIO FILE

This function allows recorder songs stored in internal memory to be played back and saved (converted) as an audio file to a USB device in either MP3 or WAV format.

In order to perform this function, first follow the explanation on page 31 to record a song to internal memory.

◇ SELECTING THE INTERNAL RECORDER SONG

□ Step 1

Connect a USB device, then press the PLAY/STOP button.

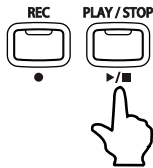

The Internal Recorder / USB Recorder selection screen will be shown in the LCD display.

```
Int. Recorder ▲
USB Recorder ▼
```

□ Step 2

Press the VALUE ▲ button to select the Internal Recorder function.

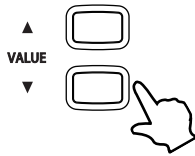

The Internal Recorder screen will be shown in the LCD display, with Song 1 selected automatically.

```
Rec Part= 1
Bar= 1- 1 ↓=100
```

Press the MENU buttons to select the desired song memory, and the VALUE buttons to select the desired part.

□ Step 3

Press the USB button.

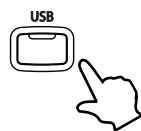

The LED indicator for the USB button will turn on, and the Convert to Audio format selection screen will be shown in the LCD display.

```
Convert to Audio
Format = MP3
```

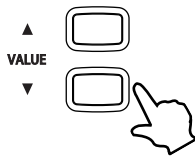

Press the VALUE buttons to select either WAV or MP3 audio file formats.

- MP3 audio files require less storage space than WAV audio files.
- A 1GB USB memory device can store over 12 hours of MP3 audio data.

□ Step 4

Press the REC button.

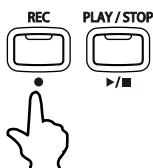

The LED indicator for the REC button will start to flash to indicate that the recorder is in standby mode.

```
Song91 Part=1&2*
Convert ↓=100
```

A recording timer will be shown in the LCD display

◇ STARTING THE CONVERSION

- Step 5
Press the PLAY/STOP button.

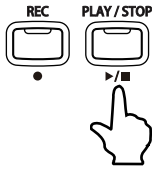

The LED indicators for the REC and PLAY/STOP buttons will turn on, and the conversion will start.

```
Converting
00:24
```

- Notes played on the keyboard will also be recorded to the audio file.

- Step 6
Press the PLAY/STOP button.

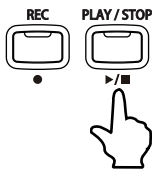

The LED indicators for the PLAY/STOP and REC buttons will turn off, and recording will stop.

```
Save to USB?
Yes+REC No+STOP
```

A confirmation message will be shown in the LCD screen, prompting to save the converted audio file.

◇ SAVING THE CONVERTED AUDIO FILE

- Step 7
Press the REC button to save the converted audio file to the USB memory device.

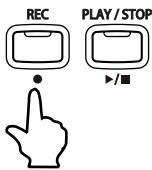

The filename entry screen will be shown in the LCD display.

```
Song name:
MP3 Song 01 +REC
```

- To cancel saving the converted audio file and exit the USB Recorder, press the PLAY/STOP button.

- Step 8
Press the MENU and VALUE buttons to enter a name for the converted audio file.

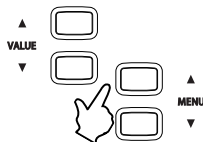

Press the VALUE buttons to select the character.
Press the MENU buttons to move the cursor.

```
Song name:
Soul Peas +REC
```

- New files are limited to a maximum name length of 12 characters.
- 'MP3 Song 01' or 'WAV Song 01' will be used as the default name for the converted audio files. The number will increase automatically with each recording.

- Step 9
Press the REC button again to save the recorded audio file to the USB memory device.

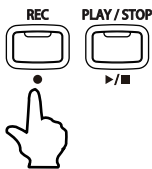

A confirmation message will be shown in the LCD display to indicate that the converted audio file has been saved.

```
Saving...
```

After saving, the audio file will automatically be selected for playback (page 39).

```
Complete!
```

- The saved audio file will be stored in the root folder of the USB device. It is not possible to store the file in a different folder.
- The audio recorder records sounds produced by the instrument only. Devices connected to the LINE IN jacks will not be recorded.
- If the specified name already exists, an overwrite confirmation message will be shown in the LCD screen prompting to confirm or cancel the save operation.

```
SoulPeas
Vol.040 00:00
```

6. USB OPERATIONS

The USB button can be used as an alternative method to access the USB Recorder functions, and also to perform a selection of additional USB operations to save, delete, rename, mkdir, and format.

 Do not attempt to disconnect USB devices while they are being accessed. Doing so may result in data loss or permanent damage

◇ ACCESSING THE USB RECORDER

- Step 1
Connect a USB device, then press the USB button.



The main USB menu will be shown in the LCD display.

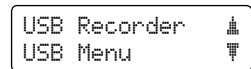

- Step 2
Press the VALUE ▲ button to select the USB Recorder.

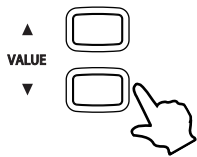

A message will be shown in the LCD display, prompting to select the REC or PLAY/STOP buttons.

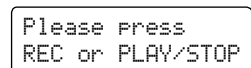

Press the REC button to access the USB Recorder's record functions, or the PLAY/STOP button to access the USB Recorder's play functions.

- For more information about the USB Recorder function, please refer to page 36.

◇ ACCESSING THE USB MENU FUNCTIONS

- Step 1
Connect a USB device, then press the USB button.



The main USB Menu will be shown in the LCD display.

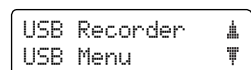

- Step 2
Press the VALUE ▼ button to select the USB Menu.

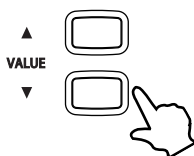

There are five USB operations available: save, rename, delete, mkdir, and format.

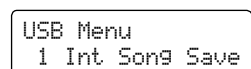

Press the MENU buttons to cycle through the different USB operations, then the VALUE buttons to select the function.

To return to the previous menu, press the STOP button.

1) INTERNAL SONG SAVE

This function can be used to save songs recorded using the CN43 piano's internal recorder to a USB device.

□ Step 1

Press the VALUE buttons to select the song to be saved, then press the REC button.

```
Int Song Save
Song1      +REC
```

□ Step 2

Press the MENU buttons to move the cursor, and the VALUE buttons to choose a character to name the recorded song, then press the REC button.

```
Int Song Rename
NewSong9   +REC
```

□ Step 3

Press the MENU buttons to scroll through the list of files and directories, then press the VALUE button to select the destination directory in which to save the internal song.

□ Step 4

Press the REC button again to save the recorded song to the USB device.

'Executing...' and then 'Complete!' will be shown in the LCD screen.

2) RENAME FILE

This function can be used to rename songs and directories stored on a USB device.

□ Step 1

Press the MENU and VALUE buttons to scroll through the list of files and directories, then press the REC button to select the song or directory to be renamed.

```
Rename
Song1     +REC
```

□ Step 2

Press the MENU buttons to move the cursor, and the VALUE buttons to choose a character to rename the recorded song.

```
Rename
Song2     +REC
```

□ Step 3

Press the REC button again to rename the recorded song stored on the USB device.

'Executing...' and then 'Complete!' will be shown in the LCD screen.

3) DELETE FILE

This function can be used to delete songs and empty directories stored on a USB device.

Step 1

Press the MENU and VALUE buttons to scroll through the list of files and directories, then press the REC button to select the song or directory to be deleted.

A delete confirmation request will be shown in the LCD screen.

```
Sure?  
Yes→REC No→STOP
```

Press the PLAY/STOP button to cancel.

Step 2

Press the REC button again to delete the recorded song from the USB device.

'Executing...' and then 'Complete!' will be shown in the LCD screen.

4) MAKEDIR

This function can be used to make new directories on a USB device.

Step 1

Press the MENU and VALUE buttons to scroll through the list of files and directories, then press the REC button to select the destination for the directory to be made.

```
Dir Name  
userdir
```

Step 2

Press the MENU buttons to move the cursor, and the VALUE buttons to choose a character to rename the new directory.

```
Dir Name  
_mdir
```

Step 3

Press the REC button again to make a new directory on the USB device.

'Executing...' and then 'Complete!' will be shown in the LCD screen.

5) FORMAT USB

This function can be used to format a USB device for use in the CN43 piano.

Step 1

Press the REC button.

A format confirmation request will be shown in the LCD screen.

Press the PLAY/STOP button to cancel.

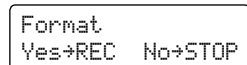

Format
Yes→REC No→STOP

Step 2

Press the REC button again to format the selected USB device.

'Executing...!' and then 'Complete!' will be shown in the LCD screen.

6. RHYTHM SECTION

◇ RHYTHM SECTION OVERVIEW

The CN43 digital piano's Rhythm Section function provides automatic backing tracks that are suitable for accompanying various musical styles. There are 100 different types of backing available, consisting of drums, bass, guitar, organ, etc., allowing musicians to enliven their performances with multi-instrumental accompaniments.

■ Rhythm Section chord progression methods

There are three different methods to control the Rhythm Section chord progression:

Method	Chord Progression	Lower Section	Upper Section
Method 1	Manual	Chord control	Melody play
Method 2	Preset (automatic)	Melody play	
Method 3	Custom (automatic)	Melody play	

■ Rhythm Section patterns

Each Rhythm Section style consists of four pattern types: Count-in, Basic/Variation, Fill-in and Ending.

Pattern type	Explanation	No. of bars
Count-in (drums only)	A short pattern used to count-in the Basic/Variation pattern.	1/2
Basic/Variation	The Basic pattern provides a simple, unobtrusive backing accompaniment, while the Variation pattern builds on the Basic pattern, often adding more complicated, musically expressive phrases.	4/8
Fill-in	A short pattern that can be used when repeating phrases or as a bridge between Basic and Variation patterns.	1
Ending	A short pattern used to end all parts of the Rhythm Section appropriately.	1

■ One Finger Ad-lib™

The One Finger Ad-lib™ feature of the Rhythm Section provides an enjoyable way of creating music by simply pressing one key at a time.

When enabled in the Function menu, One Finger Ad-lib™ allows various musical phrases to be performed at any time, by pressing one of the topmost 17 keys on the keyboard. Each phrase will play for one bar, and will match the key/chord currently used by the Rhythm Section.

- Please refer to page 79 for more information.

1) ACTIVATING THE RHYTHM SECTION

□ Step 1

Press the RHYTHM SECTION button.

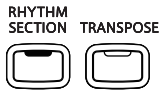

The LED indicator for the RHYTHM SECTION button will turn on, indicating that the Rhythm Section function has been activated.



```
FnkShuffle1 All
C           J=108
```

The currently selected Rhythm Section style will be shown in the LCD screen.

The LED indicator for the SPLIT button will also turn on, indicating that the Lower section of the keyboard (from F#2 and below) will be used to control the Rhythm Section chord progression, and the Upper section of the keyboard will be used to play the melody.

The Rhythm Section Split Point can be freely adjusted, please refer to the instructions on page 60 for more information.

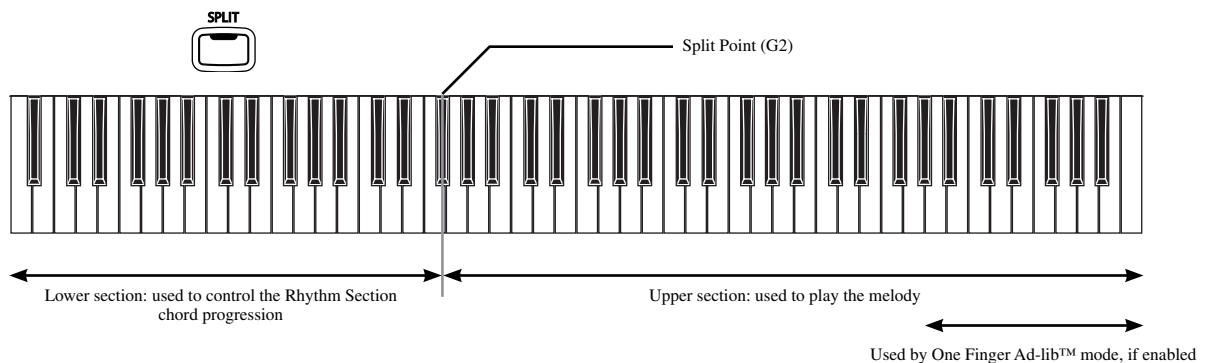

C 7

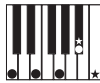

When playing a chord in the Lower section, the name of the chord will be shown in the LCD screen. Please refer to page 105 for a complete listing of recognised chord types.

- Any changes made to the Rhythm Section Split Point will remain until the power is turned off.
- When the power is turned off, the Rhythm Section Split Point will return to the default setting of 'G2', however it is possible to use the USER MEMORY function to store the preferred Rhythm Section Split Point. Please refer to the instructions on page 87 for more information.

2) PLAYING WITH THE RHYTHM SECTION

□ Step 1

Press the PLAY/STOP button.

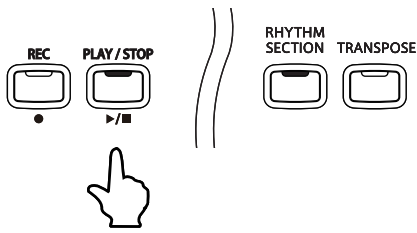

The LED indicator for the PLAY/STOP button will turn on, the Count-in drum pattern will start, and a countdown will be shown in the LCD screen.

After the Count-in, the Rhythm Section will change to the Basic pattern. During this time, the Lower section of the keyboard (from F#2 and below) will be used to control the Rhythm Section chord progression, and the Upper section of the keyboard will be used to play the melody.

After 8 bars of the Basic pattern have been played, the Rhythm Section will automatically play the Fill-in pattern. To turn off the Auto Fill-in function, or to adjust the number of bars between each Auto Fill-in, please refer to the instructions on page 78.

□ Step 2

Play chords in the Lower section of the keyboard.

The name of the chord will be shown in the LCD screen.

The Rhythm Section accompaniment will change, matching the chord that is played.

□ Step 3

Press the PLAY/STOP button again.

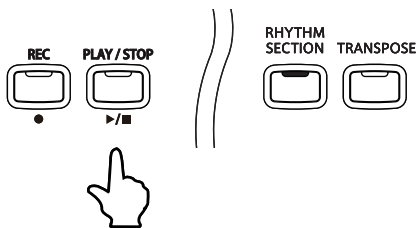

The Rhythm Section will automatically play the Ending pattern, the accompaniment will stop, and the LED indicator for the PLAY/STOP button will turn off.

- When Manual Chord Progression is selected, only the Upper section of the keyboard can be used to play the melody. When Preset Chord Progression is selected however, all 88 keys of the keyboard can be played freely. Please refer to page 61 for more information.
- The Split mode function cannot be used while the Rhythm Section function is activated. The Dual mode function, however, can still be used.

3) RHYTHM SECTION STYLES

The CN43 digital piano Rhythm Section function features a wide selection of accompaniment styles, ranging from Pop, Rock, Ballads, and Jazz, to Funk, Dance, Latin, and World Music styles. Please refer to page 104 for a complete listing of available Rhythm Section styles.

◇ SELECTING THE RHYTHM SECTION STYLE

□ Step 1

Press the ▼ or ▲ MENU buttons to select the desired Rhythm Section style.

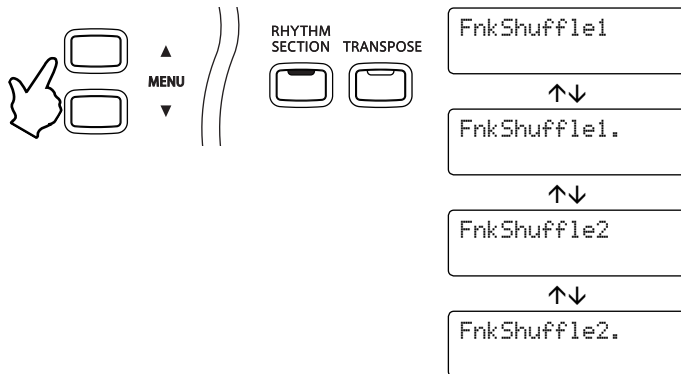

The currently selected style NAME will be shown in the LCD screen.
Indicates that the Variation pattern is selected.

□ Step 2

Press the PLAY/STOP button to start the Rhythm Section accompaniment.

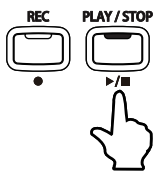

The LED indicator for the PLAY/STOP button will turn on, and the Rhythm Section accompaniment will start to play.

□ Step 3

Press the ▼ or ▲ MENU buttons to select a different Rhythm Section style or variation.



The Fill-in pattern will be played, and the Rhythm Section style will change.

□ Step 4

Press the PLAY/STOP button again to stop the Rhythm Section accompaniment.

The Rhythm Section will automatically play the Ending pattern, the accompaniment will stop, and the LED indicator for the PLAY/STOP button will turn off.

- The Rhythm Section style can be changed either before the accompaniment starts, or while the accompaniment is playing.

◇ SELECTING THE RHYTHM SECTION GENRE

Selecting a specific accompaniment genre allows Rhythm Section styles to be selected more efficiently.

□ Step 1

Press and hold the RHYTHM SECTION button, then press the ▼ or ▲ MENU buttons to select the desired Rhythm Section genre.

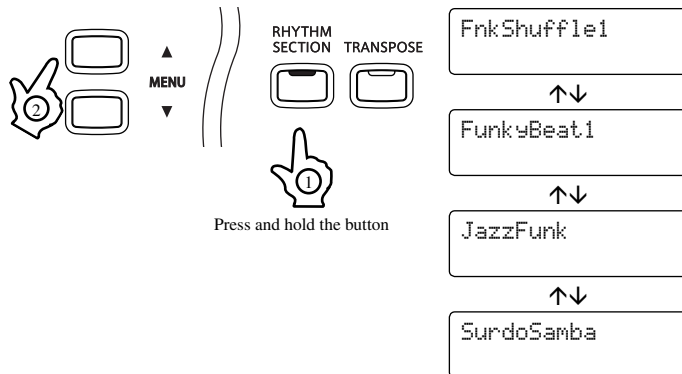

The currently selected style NAME will be shown in the LCD screen.

□ Step 2

Press the PLAY/STOP button to start the Rhythm Section accompaniment.

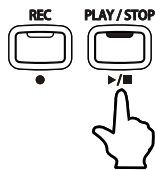

The LED indicator for the PLAY/STOP button will turn on, and the Rhythm Section accompaniment will start to play.

□ Step 3

Press and hold the RHYTHM SECTION button, then press the ▼ or ▲ VALUE buttons to select a different Rhythm Section genre.

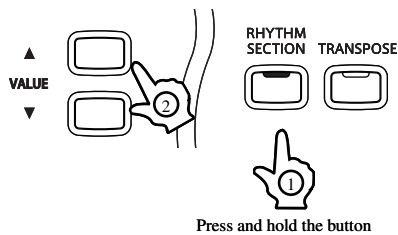

The Fill-in pattern will be played, and the Rhythm Section genre will change.

□ Step 4

Press the PLAY/STOP button again to stop the Rhythm Section accompaniment.

The Rhythm Section will automatically play the Ending pattern, the accompaniment will stop, and the LED indicator for the PLAY/STOP button will turn off.

- The Rhythm Section genre can be changed either before the accompaniment starts, or while the accompaniment is playing.
- Please refer to page 104 for a complete listing of available Rhythm Section genres and styles.

4) RHYTHM SECTION PARTS

Each Rhythm Section style consists of 4 parts:

1. Drums
2. Bass
3. Guitar
4. Others (Strings, Organ, Electric Piano, etc.)

By default, all four parts of a Rhythm Section style will be turned on, however, the Part function allows different parts to be turned on or off, tailoring the accompaniment for specific needs.

LCD screen	Enabled Rhythm Section part(s)
B+Dr	Drums, Bass
Drum	Drums
All	All parts

□ Step 1

Press the VALUE button.

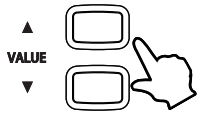

The LED indicator for the PART button will turn on, indicating that only the Drums and Bass parts of the Rhythm Section will be played.

- The Rhythm Section Part setting can be changed either before the accompaniment starts, or while the accompaniment is playing.
- Any changes made to the Rhythm Section Part setting will remain until the power is turned off.
- When the power is turned off, the Rhythm Section Part setting will return to the default setting, however it is possible to use the USER MEMORY function to store the preferred Rhythm Section Part setting. Please refer to the instructions on page 87 for more information.

5) ADJUSTING THE RHYTHM SECTION TEMPO

□ Step 1

Press and hold the TEMPO button.

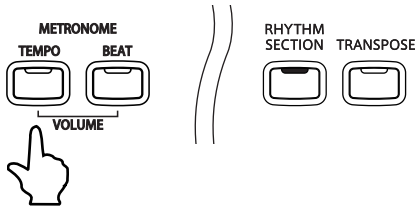

□ Step 2

Press the ▼ or ▲ VALUE buttons to adjust the Rhythm Section tempo to the desired value.



The Rhythm Section tempo can be adjusted within the range of 10-400 beats per minute.

□ Step 3

Release the TEMPO button.

- The Rhythm Section tempo can be adjusted either before the accompaniment starts, or while the accompaniment is playing.
- Any changes made to the Rhythm Section tempo will remain until the power is turned off.

6) ADJUSTING THE RHYTHM SECTION VOLUME

□ Step 1

Press and hold the TEMPO and BEAT buttons simultaneously.

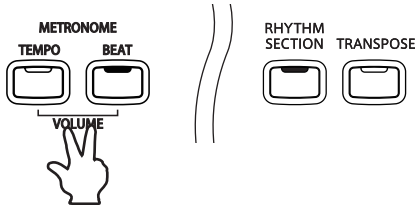

□ Step 2

Press the ▼ or ▲ VALUE buttons to adjust the Rhythm Section volume to the desired level.

The Rhythm Section volume can be adjusted within the range of 1 (soft) to 10 (loud).



□ Step 3

Release the TEMPO and BEAT buttons simultaneously.

- The Rhythm Section volume can be adjusted either before the accompaniment starts, or while the accompaniment is playing.
- Any changes made to the Rhythm Section volume will remain until the power is turned off.
- When the power is turned off, the Rhythm Section volume will return to the default setting of '5', however it is possible to use the Memory Backup function to store the preferred Rhythm Section volume. Please refer to the instructions on page 70 for more information.

7) ADJUSTING THE RHYTHM SECTION SPLIT POINT

The Split Point specifies the Lower section of the keyboard used to control the Rhythm Section chord progression, and the Upper section of the keyboard used to play the melody. This point can be adjusted, allowing the Lower and Upper sections to be increased or decreased.

□ Step 1

Press and hold the SPLIT button, then press a key on the keyboard.

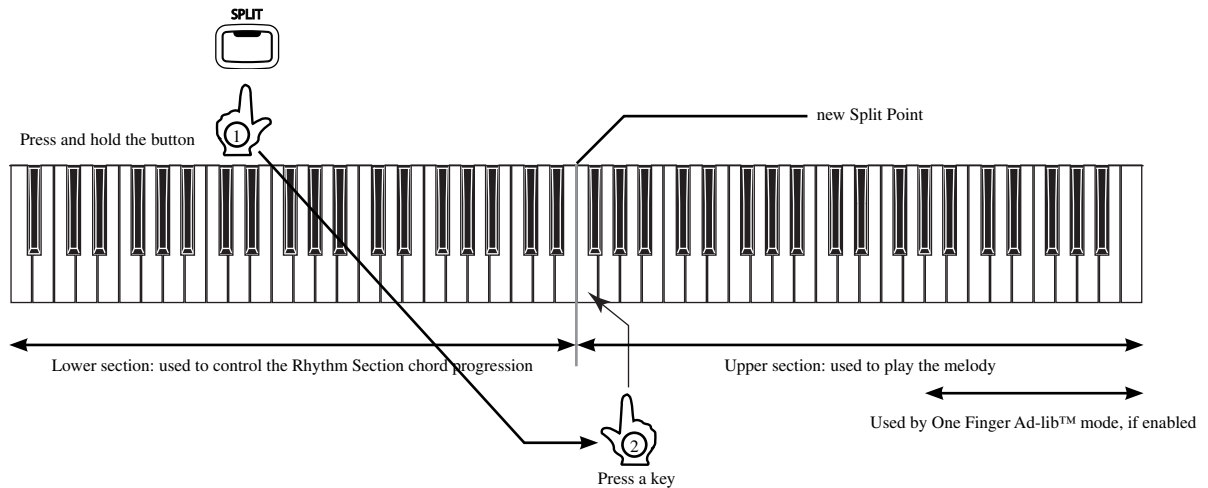

The pressed key will become the lowermost note for the Upper section of the keyboard, used to control the Rhythm Section chord progression.

- The specified Rhythm Section Split Point will also be used for the Split mode function.
- Any changes made to the Rhythm Section Split Point will remain until the power is turned off.
- When the power is turned off, the Rhythm Section Split Point will return to the default setting of 'G2', however it is possible to use the USER MEMORY function to store the preferred Split point. Please refer to the instructions on page 87 for more information.

8) PRESET CHORD PROGRESSION

Preset Chord Progression mode allows all 88 keys of the keyboard to be played freely, while the Rhythm Section plays an automatic accompaniment.

◇ ACTIVATING PRESET CHORD PROGRESSION MODE

Press and hold the RHYTHM SECTION button to activate Preset Chord Progression mode.

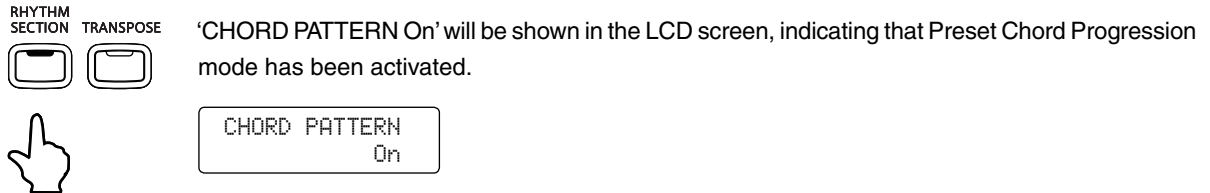

The LED indicator for the SPLIT button will turn off, indicating that all 88 keys of the keyboard can be played freely.

◇ SELECTING THE PRESET CHORD PROGRESSION STYLE

The CN43 digital piano features 100 different Preset Chord Progression styles, suitable for accompanying various types of music.

Press and hold the RHYTHM SECTION button, then press the ▼ or ▲ VALUE buttons to select the desired Preset Chord Progression style.

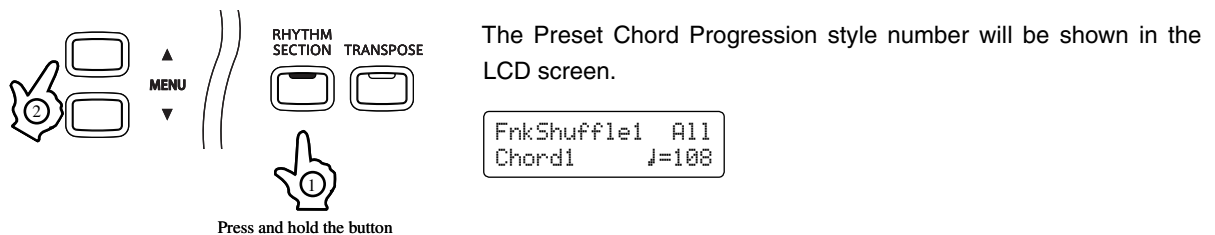

- Each Rhythm Section style utilises its own Preset Chord Progression. Please refer to page 109 for a complete listing of available Preset Chord Progression styles.
- When the Preset Chord Progression mode has been activated, the Auto Fill-in function will be disabled. However, the Rhythm Section will automatically play the fill-in pattern at the end of the final bar of the Preset Chord Progression style phrase.

◇ DEACTIVATING PRESET CHORD PROGRESSION MODE

Press the RHYTHM SECTION button to deactivate Preset Chord Progression mode.

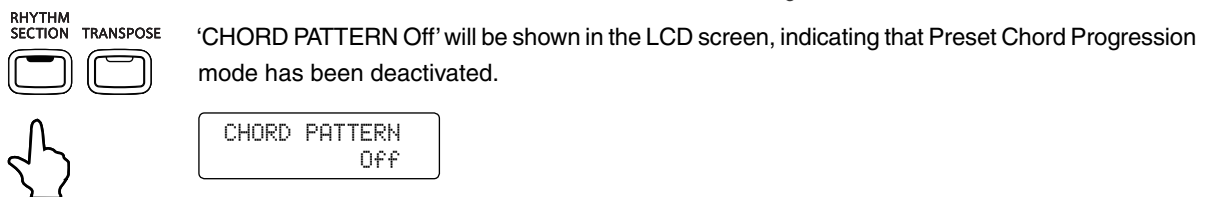

The LED indicator for the SPLIT button will turn on, indicating that the Lower section of the keyboard (from F#2 and below) will be used to control the Rhythm Section chord progression, and the Upper section of the keyboard will be used to play the melody.

9) RECORDING THE RHYTHM SECTION

It is also possible to record a Custom Chord Progression to PART1 of a song memory using the Recorder function. This allows all 88 keys of the keyboard to be played freely, while the Rhythm Section plays an automatic accompaniment.

The following Rhythm Section settings will also be captured prior to recording:

- Rhythm Section style *
- Rhythm Section volume
- Rhythm Section part settings
- Lower section chord progression *
- Rhythm Section tempo
- Preset Chord Progression style
- Preset Chord Progression On/Off

* Changes made during recording will also be captured.

In the following example, the Recorder function will be used to capture a Custom Chord Progression to the SONG2 memory, and then played back.

□ Step 1

Press the RHYTHM SECTION button.

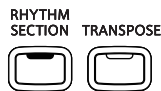

The LED indicator for the RHYTHM SECTION button will turn on, indicating that the Rhythm Section function has been activated.



The currently selected Rhythm Section style will be shown in the LCD screen.

□ Step 2

Press the ▼ or ▲ MENU buttons to select the 'Funky Beat 1' style.

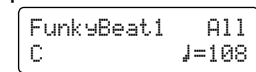

'FunkyBeat1' will be shown in the LCD screen.

□ Step 3

Press the REC button, then press the MENU button to select SONG2, and the VALUE button to select PART1.

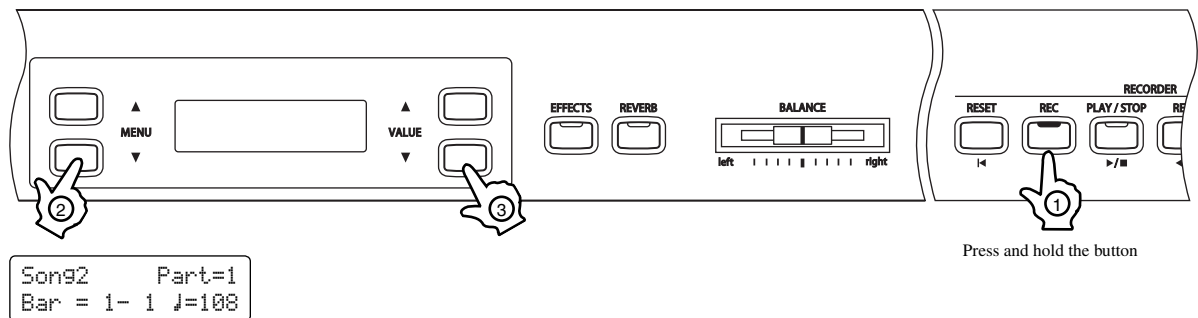

Press and hold the button

□ Step 4

Press the PLAY/STOP button to start recording.

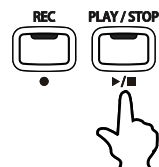

The LED indicators for the PLAY/STOP and REC buttons will turn on, the Count-in drum pattern will start, and a countdown will be shown in the LCD screen.

□ Step 5

Play chords in the Lower section of the keyboard.

The name of the chord will be shown in the LCD screen.

□ Step 6

Press the PLAY/STOP button again to stop recording.

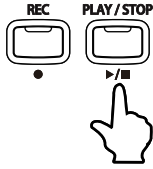

The Rhythm Section will automatically play the Ending pattern, the accompaniment will stop, and the LED indicators for the PLAY/STOP button and the REC button will turn off and the newly recorded part will be saved to memory automatically.

Saving may take a few moments and during this time the piano will not perform any other operations.

The RHYTHM SECTION button will automatically be turned off.

□ Step 7

Press the PLAY/STOP button.

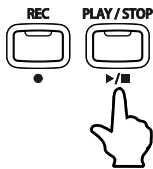

The Rhythm Section will start to play, following the recorded Custom Chord Progression.

- The Rhythm Section / Custom Chord Progression can only be recorded to PART1 of a recorder song.
- Keys played in the Upper section will also be captured while the Rhythm Section is recording, allowing both a Custom Chord Progression and melody to be recorded to PART1.

10) RECORDING THE RHYTHM SECTION TO AN AUDIO FILE

It is also possible to record the Rhythm Section using the USB Recorder. This function allows high quality MP3/WAV audio recordings to be made of an entire performance, directly on the instrument.

- Step 1**
Connect a USB memory device, then press the REC button.

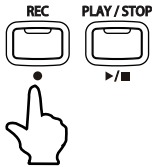

The Internal Recorder / USB Recorder selection screen will be shown in the LCD display.

```
Int. Recorder  ▲
USB Recorder   ▼
```

- The USB Recorder can also be accessed via the USB Menu (page 48).

- Step 2**
Press the VALUE ▼ button to select the USB Recorder function.

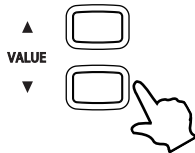

The LED indicator for the USB button will turn on, and the USB Recorder format selection screen will be shown in the LCD display.

```
USB Record
Format = MP3
```

Press the VALUE buttons to select either WAV or MP3 audio file formats.

- Step 3**
Press the REC button.

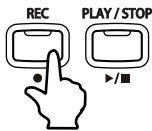

The LED indicator for the REC button will start to flash to indicate that the recorder is in standby mode.

```
USB Record  MP3
-Standby-  00:00
```

A recording timer will be shown in the LCD display.

- Step 4**
Press the RHYTHM SECTION button.

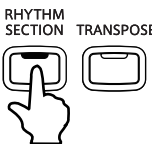

The LED indicator for the RHYTHM SECTION button will turn on to indicate that the Rhythm Section has been enabled.

```
FnkShuffle1  All
C              ♯=108
```

Follow the instructions on pages pp.55-58 to set the Rhythm Section style, parts, tempo, etc.

- Step 5**
Press the PLAY/STOP button.

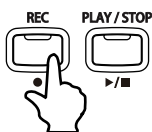

The LED indicator for the REC and PLAY/STOP buttons will turn on, the Rhythm Section accompaniment will play, and recording will start.

```
USB Record  MP3
Recording  00:24
```

- Step 6**
Following the instructions from Step 5 on page 37 to save the recorded audio file.

7. MENU FUNCTIONS

The Menu Functions allow various parameters for controlling the CN43 piano's tuning, system and MIDI functions to be adjusted.

1) Brilliance	13) Touch
2) Lower Octave Shift	14) Auto Fill-In
3) Lower Pedal On/Off	15) O.F.A.
4) Layer Octave Shift	16) MIDI Channel
5) Layer Dynamics	17) Transmit Program Change On/Off
6) Damper Hold	18) Local Control On/Off
7) Damper Effect	19) Multi-Timbral Mode On/Off
8) String Resonance	20) Channel Mute (MIDI Ch. On/Off)
9) Four Hands On/Off	21) Sending Program Change Numbers
10) Tuning	22) MIDI Clock
11) Temperament	23) User Memory
12) Key of Temperament	24) Factory Reset

When the MENU ▲ button is pressed, the first menu item is displayed. When the MENU ▼ is pressed, the last menu item is displayed. Press the MENU buttons to scroll through the various menu items in ascending / descending order.

1) BRILLIANCE

This function allows the brightness of the sound to be adjusted.

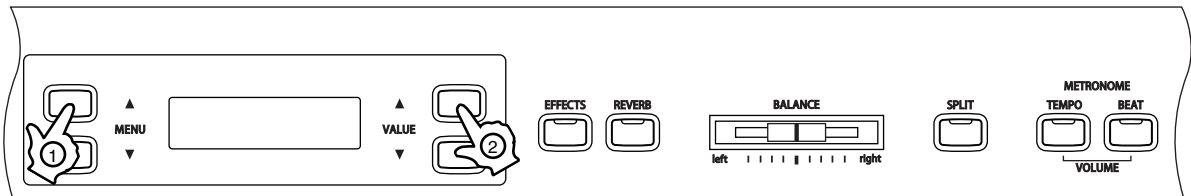

- Step 1**
Press the MENU buttons to select the Brilliance function.

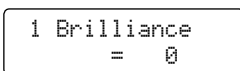

The value will be shown on the second line of the LCD screen.

- Step 2**
Press the VALUE buttons to select the desired Brilliance value.

The Brilliance value can be set within the range of -10 to +10.

Plus settings produce a brighter tone, minus settings produce a mellower tone.

- Step 3**
Press any one of the SOUND SELECT buttons to exit the menu.

- The Brilliance function will return to the default setting of '0' each time the power is turned off.
- Use the USER MEMORY function (page 87), to save the desired brilliance setting, allowing the current brilliance setting to remain even after the power is turned off.

2) LOWER OCTAVE SHIFT

This function allows the lower part to be raised by one, two, or three octaves when using SPLIT mode.

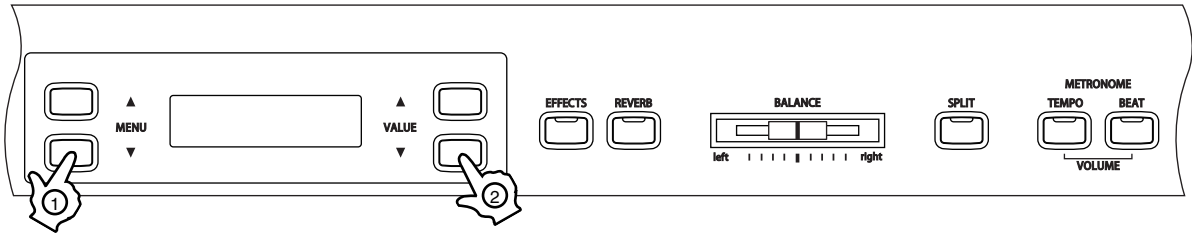

□ Step 1

Press the MENU buttons to select the Lower Octave Shift function.

```
2 LowerOctShift
= 0
```

The Lower Octave Shift value will be shown on the second line of the LCD screen.

□ Step 2

Press the VALUE buttons to set the desired Lower Octave Shift value.

The value can be set within the range of 0 to +3.

□ Step 3

Press any one of the SOUND SELECT buttons to exit the menu.

- The Lower Octave Shift function will return to the default setting of '0' each time the power is turned off.
- Use the USER MEMORY function (page 87), to save the desired Lower Octave Shift setting, allowing the current Lower Octave Shift setting to remain even after the power is turned off.

3) LOWER PEDAL ON / OFF

This function determines whether the sustain pedal will be active for lower part sound when in SPLIT mode. The default setting is OFF, which means the sustain pedal is not active for lower part sound.

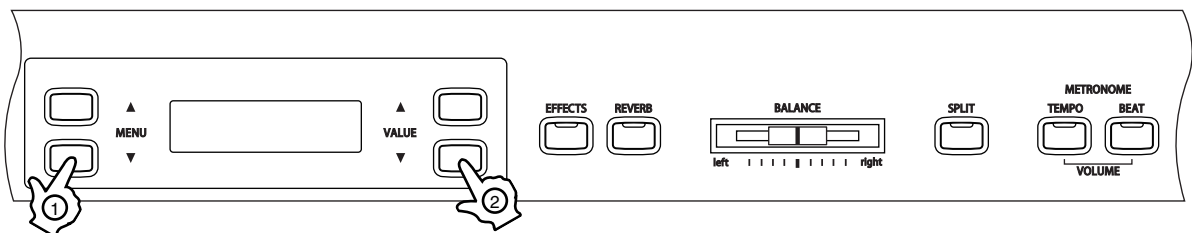

□ Step 1

Press the MENU buttons to select the Lower Pedal ON/OFF function.

ON or OFF will be shown on the second line of the LCD screen.

```
3 Lower Pedal
= Off
```

□ Step 2

Press the VALUE buttons to turn the Lower Pedal Function ON or OFF.

When set to ON, the sustain pedal is active for the lower sound when the pedal is depressed.

When set to OFF, the sustain pedal will not be active for the lower sound when the pedal is depressed, however the sustain pedal will still be active for the upper sound.

□ **Step 3**

Press any one of the SOUND SELECT buttons to exit the menu.

- The Lower Pedal ON/OFF function will return to the default setting of 'OFF' each time the power is turned off.
- Use the USER MEMORY function (page 87), to save the desired Lower Pedal ON/OFF setting, allowing the current Lower Pedal ON/OFF setting to remain even after the power is turned off.

4) LAYER OCTAVE SHIFT

This function allows the octave of a layered sound (the sound displayed in the second line of the LCD screen) to be raised or lowered by one octave when using DUAL mode.

For example, when playing in dual mode using Concert Grand Piano and String Ensemble sounds, the octave range for the String Ensemble sound can be raised or lowered.

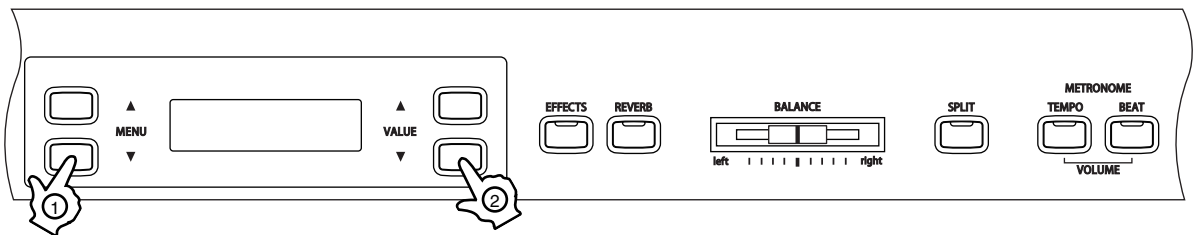

□ **Step 1**

Press the MENU buttons to select the Layer Octave Shift function.

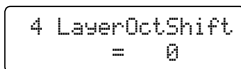

The Layer Octave Shift value will be shown on the second line of the LCD screen.

□ **Step 2**

Press the VALUE buttons to set the desired Layer Octave Shift value.

The value can be set within the range of -2 to +2.

Minus values select an octave range one or two octaves lower. Positive values select an octave range one or two octaves higher.

The octave for the sound displayed in the second line of the LCD screen when using DUAL mode will be changed.

- For some sounds it may not be possible to select a higher octave range.

□ **Step 3**

Press any one of the SOUND SELECT buttons to exit the menu.

- The Layer Octave Shift function will return to the default setting of 'OFF' each time the power is turned off.
- Use the USER MEMORY function (page 87), to save the desired Layer Octave Shift setting, allowing the current Layer Octave Shift setting to remain even after the power is turned off.

5) LAYER DYNAMICS

When using DUAL mode, sometimes simply adjusting the volume balance between the two layered sounds is not enough to create the desired sound character, especially if both sounds are very dynamic. Two equally dynamic sounds can be difficult to control and play comfortably.

The Layer Dynamics Function allows the overall dynamic sensitivity of the layered sound to be limited, in order to create a perfect blend between both sounds in the layer. In addition to reducing the volume of the layered sound, limiting the dynamic sensitivity of the layered sound also allows the layered sound to be controlled more easily in relation to the main sound.

For example, when playing Concert Grand Piano and String Ensemble sounds simultaneously using DUAL mode, the Layer Dynamics function can be used to adjust the String Ensemble dynamics.

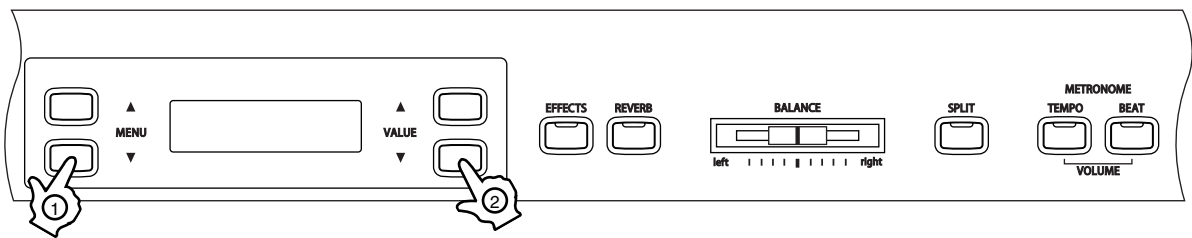

□ Step 1

Press the MENU buttons to select the Layer Dynamics function.

```
5 LayerDynamics
  = 10
```

The Layer Dynamics value will be shown on the second line of the LCD screen.

□ Step 2

Press the VALUE buttons to set the desired Layer Dynamics value.

The value can be set within the range of 1 to 10.

A value of 1 produces the greatest reduction in dynamics and a value of 10 produces no change in the dynamics. The default value is 10.

□ Step 3

Press any one of the SOUND SELECT buttons to exit the menu.

- The Layer Dynamics function will return to the default setting of '10' each time the power is turned off.
- Use the USER MEMORY function (page 87), to save the desired Layer Dynamics setting, allowing the current Layer Dynamics setting to remain even after the power is turned off.

6) DAMPER HOLD ON / OFF

This function determines whether sounds such as organ or strings should be held (ON) or gradually decay (OFF) when the damper pedal is depressed.

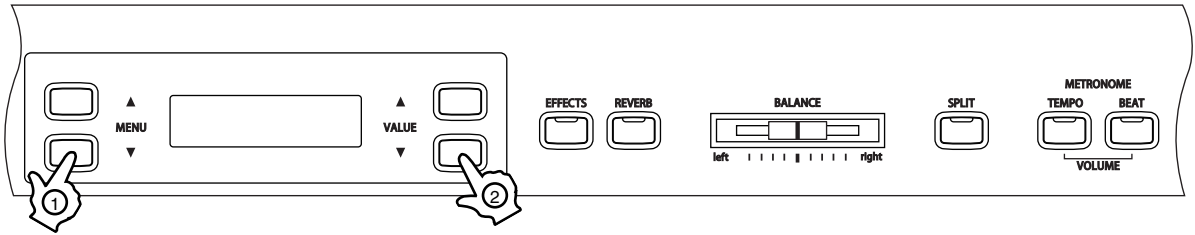

□ Step 1

Press the MENU buttons to select the Damper Hold ON/OFF function.

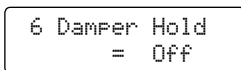

ON or OFF will be shown on the second line of the LCD screen.

□ Step 2

Press the VALUE buttons to turn the Damper Hold function ON or OFF.

When set to ON and the sustain pedal is depressed, sustained sounds will be sustained even after the keys are released.

When set to OFF and the sustain pedal is depressed, sustained sounds will begin to decay (fade out) after the keys are released.

□ Step 3

Press any one of the SOUND SELECT buttons to exit the menu.

- The Damper Hold ON/OFF function will return to the default setting of 'OFF' each time the power is turned off.
- Use the USER MEMORY function (page 87), to save the desired Damper Hold ON/OFF setting, allowing the current Damper Hold ON/OFF setting to remain even after the power is turned off.

7) DAMPER EFFECT

When the sustain pedal is depressed on an acoustic piano, all the dampers are lifted up allowing the strings to vibrate freely. When you play note or chord on the piano with the sustain pedal depressed not only will the strings for the notes you played vibrate but other strings will vibrate in sympathetic resonance. The Damper Effect function simulates the phenomenon.

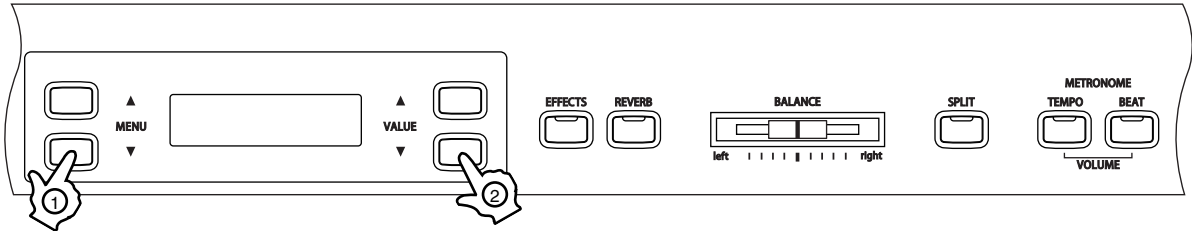

□ Step 1

Press the MENU buttons to select the Damper Effect function.

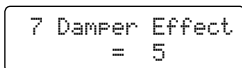

The Damper Effect value will be shown on the second line of the LCD screen

□ Step 2

Press the VALUE buttons to set the desired Damper Effect value.

You can select the level of effect from off, 1 to 10. The default setting is 5.

□ Step 3

Press any one of the SOUND SELECT buttons to exit the menu.

- The Damper Effect function will return to the default setting of '5' each time the power is turned off.
- Use the USER MEMORY function (page 87), to save the desired Damper Effect setting, allowing the current Damper Effect setting to remain even after the power is turned off.

8) STRING RESONANCE

The string resonance function simulates the phenomenon of string resonance on an acoustic piano. You can adjust the volume of the string resonance.

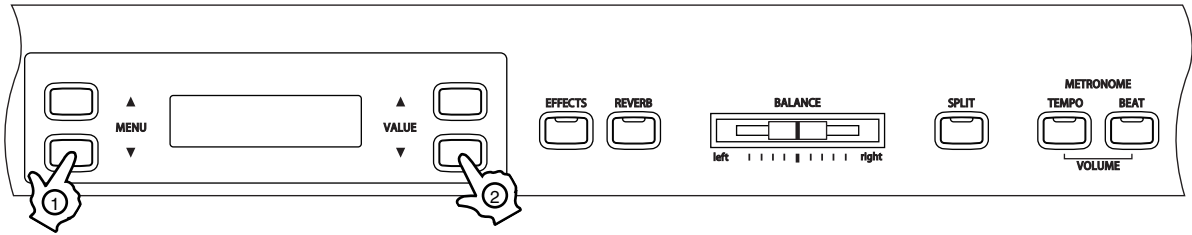

□ Step 1

Press the MENU buttons to select the String Resonance function.

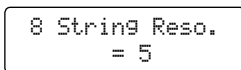

The String Resonance value will be shown on the second line of the LCD screen.

□ Step 2

Press the VALUE buttons to set the desired String Resonance value.

5 is the default setting.

String resonance will not be active when 'Off' is selected.

□ Step 3

Press any one of the SOUND SELECT buttons to exit the menu.

■ About string resonance

Even when the sustain pedal is not depressed on an acoustic piano, the strings for any notes you are holding will be un-damped and will resonate freely in sympathy with the strings of other notes that you play if they are part of the same harmonic series. In addition, adjacent notes will also be resonated. The string resonance function simulates this phenomenon. This is called "string resonance."

For example, when you play the keys shown below while holding down the C key, the string of the C key resonates and produces a sound.

(Quietly press and hold down the C key, and then quickly tap each of the keys shown below. You can hear the string resonate.)

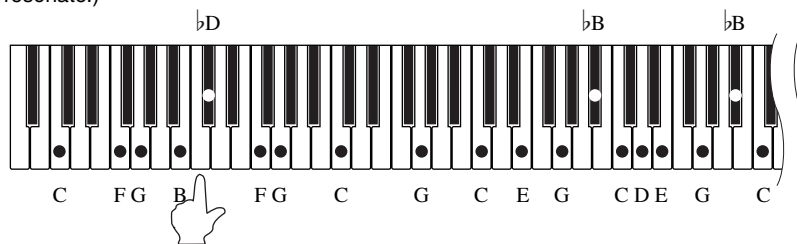

Play and hold a 'C' note.

- When you play a key while holding down an adjacent key, an acoustic piano produces a sound as a result of string resonance. The CN43 simulates this phenomenon.
- The String Resonance function will return to the default setting of '5' each time the power is turned off.
- Use the USER MEMORY function (page 87), to save the desired String Resonance setting, allowing the current String Resonance setting to remain even after the power is turned off.
- String resonance is not active when the sustain pedal is depressed.
- The string resonance function is effective only for the acoustic piano sounds.

9) FOUR HANDS ON/OFF

This function allows FOUR HANDS mode to be activated or deactivated using an alternative method to that described on page 16.

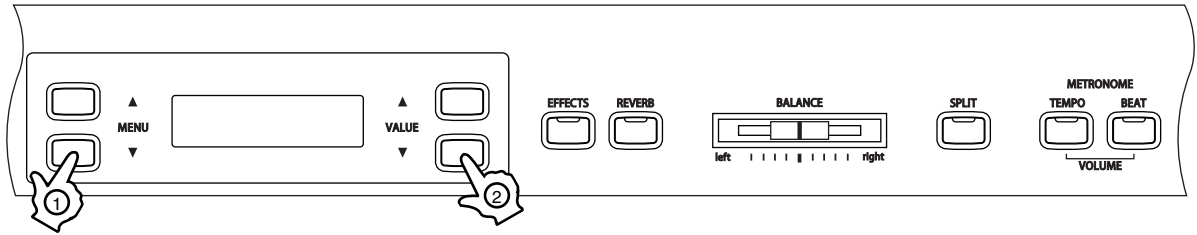

□ Step 1

Press the MENU buttons to select the FOUR HANDS ON/OFF function.

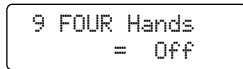

ON or OFF will be shown on the second line of the LCD screen.

□ Step 2

Press the VALUE buttons to turn the FOUR HANDS function ON or OFF.

□ Step 3

Press any one of the SOUND SELECT buttons to exit the menu.

- The FOUR HANDS ON/OFF function will return to the default setting of 'OFF' each time the power is turned off.
- Use the USER MEMORY function (page 87), to save the desired FOUR HANDS ON/OFF setting, allowing the current FOUR HANDS ON/OFF setting to remain even after the power is turned off.

10) TUNING

This function allows the piano's pitch to be finely adjusted, and may prove useful when playing with other instruments.

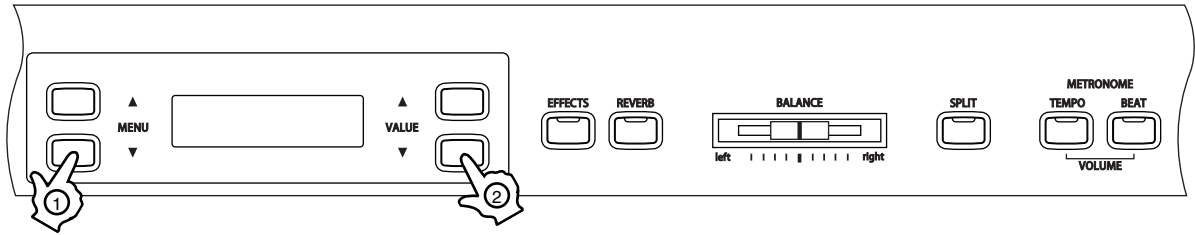

□ Step 1

Press the MENU buttons to select the Tuning function.

```
10 Tuning
   = 440.0
```

The Tuning value will be shown on the second line of the LCD screen

□ Step 2

Press the VALUE buttons to set the desired Tuning value.

The value can be set within the range of 427.0 to 453.0 (Hz).

The pitch will be changed by 0.5 Hz each time one of the VALUE buttons is pressed.

□ Step 3

Press any one of the SOUND SELECT buttons to exit the menu.

- The Tuning function will return to the default setting of '440.0 Hz' each time the power is turned off.
- Use the USER MEMORY function (page 87), to save the desired Tuning setting, allowing the current Tuning setting to remain even after the power is turned off.

11) TEMPERAMENT

The CN43 piano offers immediate access to a variety of musical temperaments popular during the Renaissance and Baroque periods. It may prove interesting and educational to experiment with different temperaments, other than the modern 'equal temperament' standard this is dominant in music today.

The following temperaments are available:

<ul style="list-style-type: none"> ◆ Equal temperament (piano) (Equal P. only) 	<p>This is the default temperament. If a piano sound is selected the tuning is stretched like an acoustic piano (EQUAL TEMPERAMENT). If any other type of sound is selected the tuning will be EQUAL (FLAT). An explanation of EQUAL TEMPERAMENT and EQUAL TEMPERAMENT (FLAT) is provided later in this section.</p> <p>If a piano sound is used in a layer with any other sound, then both sounds will use the EQUAL TEMPERAMENT (stretched) tuning.</p>
<ul style="list-style-type: none"> ◆ Pure temperament <major> (Pure major) ◆ Pure temperament <minor> (Pure minor) 	<p>This temperament, which eliminates dissonances for thirds and fifths, is still popular for choral music because of its perfect harmony.</p> <p>Performers must be aware which key they are playing in when using this temperament.</p> <p>Any key modulation will result in dissonances. When playing music in a particular key, the key of the temperament must also be correctly matched.</p> <p>When playing in a major key select Pure (Major) and when playing in a minor key select Pure (minor).</p>
<ul style="list-style-type: none"> ◆ Pythagorean temperament (Pythagorean) 	<p>This temperament, which uses mathematical ratios to eliminate dissonance for fifths, is very limited for use with chords, but it produces very characteristic melodic lines.</p>
<ul style="list-style-type: none"> ◆ Meantone temperament (Meantone) 	<p>This temperament, which uses a mean between a major and minor whole tone to eliminate dissonance for thirds, was devised to eliminate the lack of consonances experienced with certain fifths for the Mersenne pure temperament. It produces chords that are more beautiful than those with the equal temperament.</p>
<ul style="list-style-type: none"> ◆ Werckmeister III temperament (Werckmeister) ◆ Kirnberger III temperament (Kirnberger) 	<p>These two temperaments are placed in between Meantone and Pythagorean.</p> <p>For music with few accidentals, this temperament produces the beautiful chords of the mean tone, but as accidentals increase, the temperament produces the characteristic melodies of the Pythagorean temperament. It is used primarily for classical music written in the Baroque era to revive the original characteristics.</p>
<ul style="list-style-type: none"> ◆ Equal temperament (flat) (Equal Flat) 	<p>This is an 'unstretched' equal temperament that divides the scale into twelve equal semitones. This produces the same chordal intervals in all twelve keys, and has the advantage of limitless modulation of the key. However the tonality of each key becomes less characteristic and no chord is in pure consonance.</p>
<ul style="list-style-type: none"> ◆ Equal temperament 	<p>This is the most popular piano temperament. The hearing ability of a human is uneven and is not as accurate with high frequency and low frequency as it is with the middle range. This temperament's tuning is stretched to compensate for this so the sound will be heard naturally to the ears. This 'stretched' equal temperament is a practical variation of the 'unstretched' equal temperament which was invented on a mathematical basis.</p>

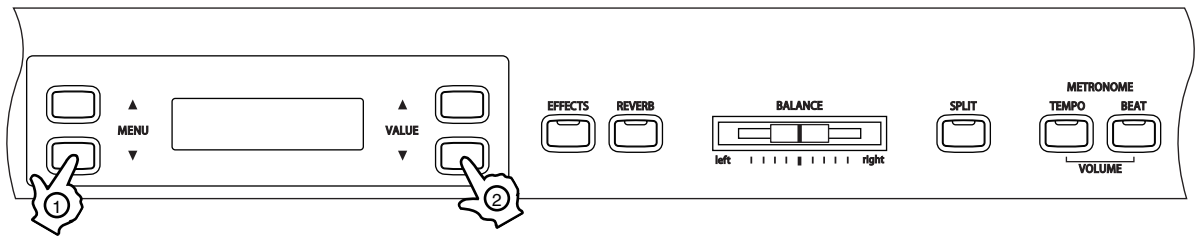

- **Step 1**
Press the MENU buttons to select the Temperament function.

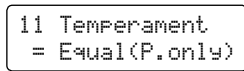

The Temperament type will be shown on the second line of the LCD screen.

- **Step 2**
Press the VALUE buttons to set the desired Temperament type.

■ Equal temperament

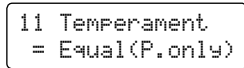

↑↓ VALUE buttons

■ Pure temperament <major>

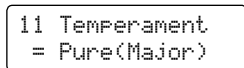

■ Pure temperament <minor>

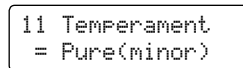

■ Pythagorean temperament

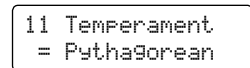

■ Meantone temperament

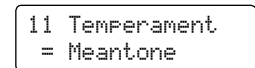

■ Equal temperament

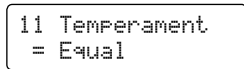

■ Equal temperament (flat)

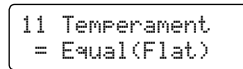

■ Kirnberger III temperament

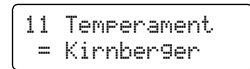

■ Werckmeister III temperament

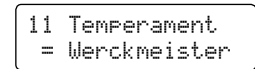

■ After selecting the desired temperament type, please read '12) KEY OF TEMPERAMENT' (page 76) for information regarding the key signature for the temperament, before continuing.

- **Step 3**
Press any one of the SOUND SELECT buttons to exit the menu.

- The Temperament type will return to the default setting of 'Equal Temperament (Piano)' each time the power is turned off.
- Use the USER MEMORY function (page 87), to save the desired Temperament setting, allowing the current Temperament setting to remain even after the power is turned off.

12) KEY OF TEMPERAMENT

Limitless modulation of the key became available only after the invention of equal temperament. When using a temperament other than equal temperament, care must be taken to choose the key signature to play in. For example, if the song to be played is written in D major, 'D' would be chosen as the temperament key.

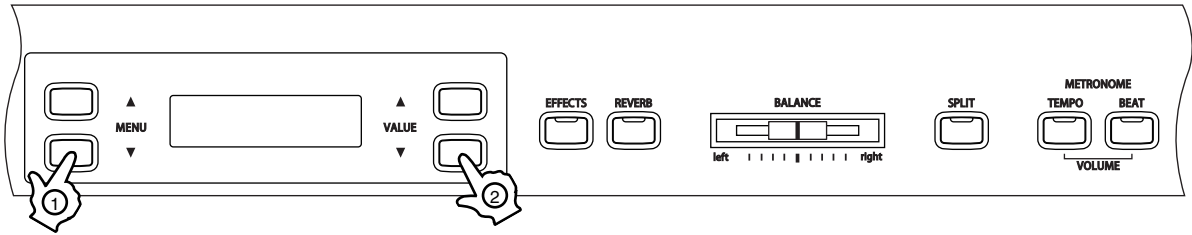

□ Step 1

Press the MENU buttons to select the Key of Temperament function.

```
12 Key of Temper
= C
```

The Temperament Key will be shown on the second line of the LCD screen.

□ Step 2

Press the VALUE buttons to set the desired Key of Temperament.

The key can be set within the range of C to B.

Please note that changing the key of the temperament will only change the 'balance' of the tuning, the pitch of the keyboard will remain unchanged.

The key of temperament function will have no effect when equal temperament is selected.

□ Step 3

Press any one of the SOUND SELECT buttons to exit the menu.

- The Key of Temperament will return to the default setting of 'C' each time the power is turned off.
- Use the USER MEMORY function (page 87), to save the desired Key of Temperament setting, allowing the current Key of Temperament setting to remain even after the power is turned off.

13) TOUCH

The TOUCH function allows different touch sensitivities for the keyboard to be selected, other than the standard touch of an acoustic piano. The sensitivity can be changed to one of five different settings: Light, Light +, Heavy, Heavy + or Off.

①Light +	: For players with a delicate touch. Requires less striking force to achieve a forte note.
②Light	: For those still developing finger strength. A louder volume is produced even when playing with a soft touch.
③Normal	: Reproduces the standard touch sensitivity of an acoustic piano.
④Heavy	: Perfect for those with strong fingers. Requires a heavier touch to produce a loud volume.
⑤Heavy +	: Requires more striking force to achieve a loud volume.
⑥Off	: A constant volume is produced regardless of how hard the keys are struck. This setting is suitable for sounds that have a fixed dynamic range such as Organ and Harpsichord.

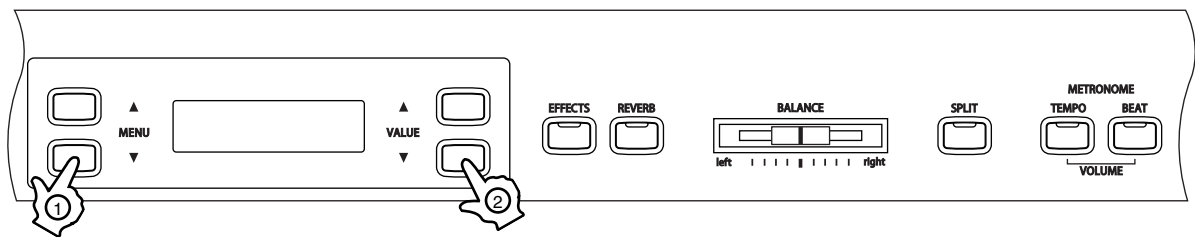

- Step 1**
Press the MENU buttons to select the Touch function.

```
13 Touch
  = Normal
```

The Touch value will be shown on the second line of the LCD screen.

- Step 2**
To change the touch type, press the VALUE buttons.

```
13 Touch
  = Light
```

The touch setting is global for all of the preset sounds. It is not possible to have individual touch settings for each preset sound.

When the power is turned off the touch settings will return to the default settings.

- LIGHT and HEAVY do not represent the physical weight of the keys. These are settings that affect the sensitivity of the keys, which determines the volume level in response to the key movement.

- Step 3**
Press any one of the SOUND SELECT buttons to exit the menu.

- The Touch function will return to the default setting of 'Normal' each time the power is turned off.
- Use the USER MEMORY function (page 87), to save the desired Touch setting, allowing the current Touch setting to remain even after the power is turned off.

14) AUTO FILL-IN

When using the Rhythm Section, this function controls how frequently the Auto Fill-in will be played.

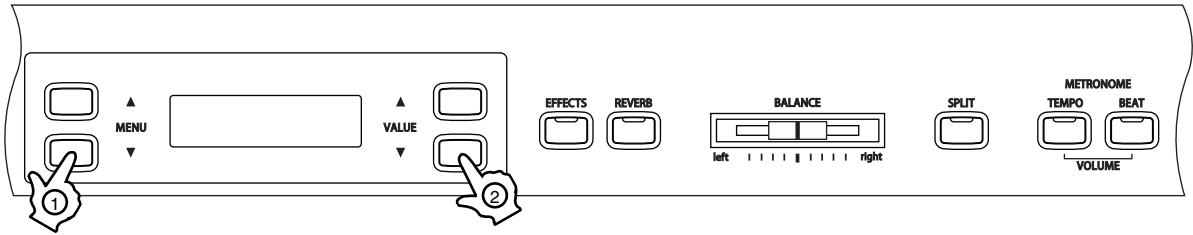

- **Step 1**
Press the MENU buttons to select the Auto Fill-In function.

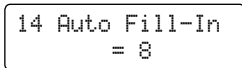

The Auto Fill-In value will be shown on the second line of the LCD screen.

- **Step 2**
Press the ▼ or ▲ VALUE buttons to select the desired Auto Fill-in setting.



The Auto Fill-in setting can be set to play every 4, 8, 12, or 16 bars.
Setting the Auto Fill-in to 'Off' will disable the Auto Fill-in.

- **Step 3**
Press any one of the SOUND SELECT buttons to exit the menu.

- The Auto Fill-in function will return to the default setting of '8' each time the power is turned off.
- Use the USER MEMORY function (page 87), to save the desired Auto Fill-in setting, allowing the current Auto Fill-in setting to remain even after the power is turned off.

15) ONE FINGER AD-LIB™ ON/OFF

The One Finger Ad-lib™ feature provides an enjoyable way of creating music by simply pressing one key at a time. When enabled, One Finger Ad-lib™ allows various musical phrases to be performed at any time, by pressing one of the topmost 17 keys on the keyboard. Each phrase will play for one bar, and will match the key/chord currently used by the Rhythm Section.

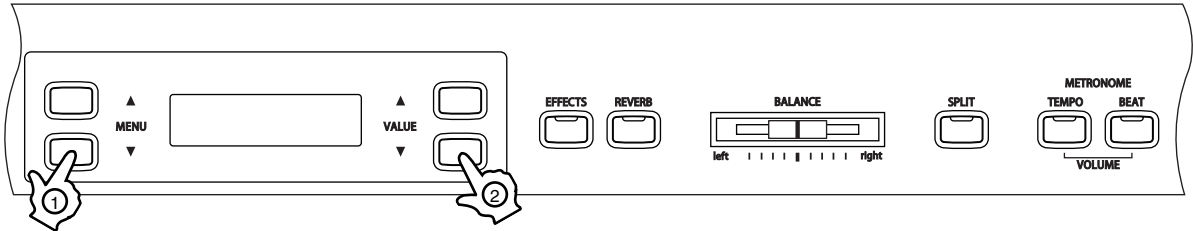

□ Step 1

Press the MENU buttons to select the One Finger Ad-Lib function.

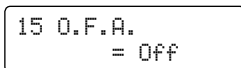

ON or OFF will be shown on the second line of the LCD display.

□ Step 2

Press the ▼ or ▲ VALUE buttons to select the desired One Finger Ad-Lib™ setting.

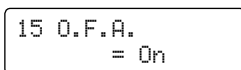

When set to 'On', pressing one of the topmost 17 keys on the keyboard while using the Rhythm Section, will play a musical phrase.

When set to 'Off', pressing one of the topmost 17 keys on the keyboard while using the Rhythm Section, will not play a musical phrase.

□ Step 3

Press any one of the SOUND SELECT buttons to exit the menu.

- The One Finger Ad-Lib ON/OFF function will return to the default setting of 'OFF' each time the power is turned off.
- Use the USER MEMORY function (page 87), to save the desired One Finger Ad-Lib™ setting, allowing the current One Finger Ad-Lib™ setting to remain even after the power is turned off.

◇ MIDI OVERVIEW

The term MIDI is an acronym for Musical Instrument Digital Interface, an international standard for connecting synthesizers, sequencers (MIDI recorders) and other electronic instruments so that they can exchange performance data.

The CN43 is equipped with two MIDI jacks for exchanging data: MIDI IN and MIDI OUT. Each uses a special cable with a DIN connector.

- MIDI IN : For receiving note, program change and other data.
- MIDI OUT : For sending note, program change and other data.
- MIDI THRU : For passing along MIDI data received to another MIDI instrument without processing.

MIDI uses channels to exchange data back and forth between MIDI devices. There are receive (MIDI IN) and transmit (MIDI OUT) channels. Most musical instruments or devices with MIDI functions are equipped with both MIDI IN and OUT jacks and are capable of transmitting and receiving data via MIDI.

The receive channels are used to receive data from another MIDI device and the transmit channels are used to transmit data to another MIDI device.

■ CONNECTION TO AN EXTERNAL SEQUENCER

When connected as shown in the illustration below, songs played on the CN43 can be recorded using a MIDI recorder, with preset sounds (such as piano, harpsichord and vibraphone, etc.) controlled by the CN43's MULTITIMBRAL MODE function to create a multi-layer MIDI recording.

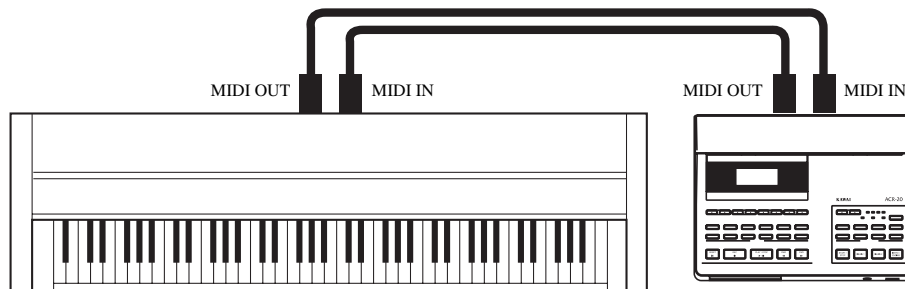

◇ CN43 MIDI FUNCTIONS

Transmit / receive keyboard note information	By transmitting MIDI data from the CN43 piano (MIDI out) a MIDI-connected keyboard can be played from the CN43 piano. Or alternatively, by receiving data (MIDI IN), the CN43 piano can be played from another MIDI-connected keyboard or device.
Transmit / receive channel setting	Specify transmit/receive channels within the range of 1 to 16.
Transmit / receive Program change (sound type) number	Transmit/receive program change data to/from a MIDI-connected musical instrument or device.
Transmit / receive pedal data	Transmit/receive sustain pedal and sustain pedal data from a MIDI-connected musical instrument or device. Sostenuto pedal data can also be transmitted.
Receive volume data	The CN43 piano will respond to MIDI volume data sent from a MIDI-connected musical instrument or device.
Multi-timbral setting	The CN43 piano is able to receive multiple channel MIDI data from a MIDI-connected musical instrument or device, when multi-timbral mode is turned on.
Transmit / receive exclusive data	Transmit/receive front panel or menu function settings as exclusive data.
Transmit recorder playback data	Songs recorded using the recorder can be played back from a MIDI-connected musical instrument or recorded by an external sequencer via the MIDI OUT jack.

Please refer to the 'MIDI IMPLEMENTATION CHART' (page 113) for further information regarding the CN43's MIDI functions.

16) MIDI CHANNEL

This function is used to determine on which MIDI channel the CN43 piano will exchange MIDI information with external MIDI devices and instruments or a personal computer.

The selected channel will function as both the transmit and receive channel.

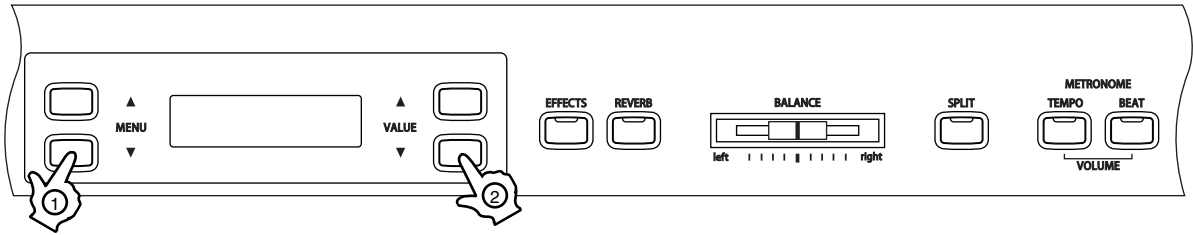

□ Step 1

Press the MENU buttons to select the MIDI channel function.

```
16 MIDI Channel
= 1 (TRS/RCU)
```

The current MIDI channel will be shown on the second line of the LCD screen.

□ Step 2

Press the VALUE buttons to select the desired MIDI channel.

The MIDI channel can be set within the range of 1 to +16.

□ Step 3

Press any one of the SOUND SELECT buttons to exit the menu.

■ The CN43 piano's MIDI channel setting defaults to receiving MIDI channel information from all channels, 1 to 16, each time the power is turned on. This is called 'omni mode on'. The CN43 piano will switch to 'omni mode off' when a specific channel is selected using the MIDI channel function, and data will only be received on that specified channel. In order to specify channel 1 in the 'omni mode off' state, first select channel 2, then select channel 1.

■ When multi-timbral mode is on (page 84):

When playing in split mode with Multi-timbral mode ON

: Notes played in the lower section of the keyboard will be transmitted on the channel that is one channel higher than the selected channel. For example, with the MIDI channel is set to 3 notes played in the lower section of the keyboard will be transmitted on channel 4.

When playing in dual mode : The notes played will be transmitted on two channels, the selected channel and the channel that is one channel higher. When channel the selected MIDI channel is 16, channel 1 will be used to transmit notes for the layered part.

17) TRANSMIT PROGRAM CHANGE ON / OFF

This function determines whether the CN43 piano will transmit program change information when pressing the SOUND SELECT buttons.

When set to ON and with Multi-Timbral mode set to OFF or ON1, pressing the SOUND SELECT buttons will send the program change numbers listed in the left half of the chart on page 86 to 93 via MIDI.

When Multi-Timbral mode is set to ON2, pressing the SOUND SELECT buttons will send the program change numbers listed in the right half of the chart on pages 93-100 via MIDI.

In addition to SOUND SELECT buttons, other button operations such as Touch Curve, DUAL, Digital Effect, and Reverb settings can also be transmitted as MIDI exclusive data when the corresponding buttons are pushed.

When set to OFF no program change or other panel information will be transmitted via MIDI.

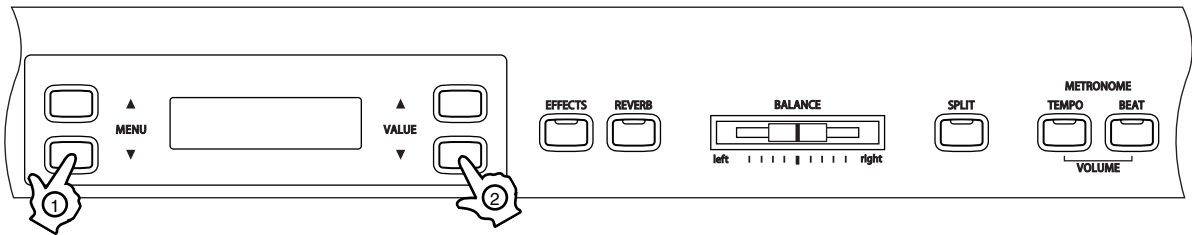

■ Please refer to page 84 for information regarding Multi-Timbral mode.

□ Step 1

Press the MENU buttons to select the Transmit Program Change ON/OFF function.

```
17 Transmit PGM
= On
```

ON or OFF will be shown on the second line of the LCD screen.

□ Step 2

Press the VALUE buttons to turn the Transmit Program Change function ON or OFF.

□ Step 3

Press any one of the SOUND SELECT buttons to exit the menu.

■ The Transmit Program Change ON/OFF function will return to the default setting of 'ON' each time the power is turned off.

■ Use the USER MEMORY function (page 87), to save the desired Transmit Program Change ON/OFF setting, allowing the current Transmit Program Change ON/OFF setting to remain even after the power is turned off.

■ When using DUAL or SPLIT mode, ON, OFF information and sound type settings for each mode are transmitted as exclusive data, but program numbers will not be transmitted.

Program numbers will also be transmitted when Multi-Timbral mode is on.

18) LOCAL CONTROL ON / OFF

This function determines whether the CN43 piano's sound will be played from the piano's keyboard (ON) or only from an external MIDI device (OFF). Even with local control set to OFF the CN43 piano's keyboard will still transmit on the selected MIDI channel to an external MIDI device or personal computer.

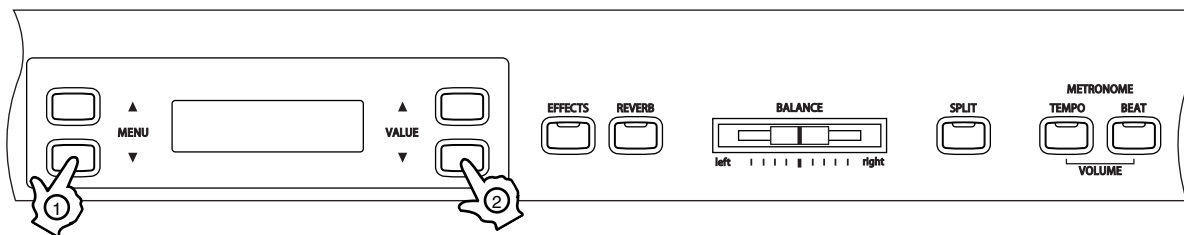

□ Step 1

Press the MENU buttons to select the Local Control ON/OFF function.

```
18 Local Control
  = On
```

ON or OFF will be shown on the second line of the LCD screen.

□ Step 2

Press the VALUE buttons to turn the Local Control function ON or OFF.

□ Step 3

Press any one of the SOUND SELECT buttons to exit the menu.

- The Local Control ON/OFF function will return to the default setting of 'ON' each time the power is turned off.
- Use the USER MEMORY function (page 87), to save the desired Local Control ON/OFF setting, allowing the current Local Control ON/OFF setting to remain even after the power is turned off.

19) MULTI-TIMBRAL MODE

This function allows the CN43 piano to receive data on more than one MIDI channel simultaneously. In this mode, the CN43 piano can play different musical parts with different sounds for each part.

This turns on the flexible 16 part Multi-Timbral capability. Individual MIDI channels can be turned ON and OFF, and assigned to any preset sound. The preset sound for each MIDI channel can be changed when the program change number for the desired sound is received from external MIDI device and instruments, or a personal computer. The CN43 piano's normal program change numbers are assigned in ON1 (corresponding to the program numbers listed in the left half of the chart on pages 93-100), while General MIDI program change numbers are assigned in ON2 (corresponding to the program number and bank numbers listed in the right half of the chart in pages 93-100). Please refer to page 85 for information regarding the Channel Mute function.

Multi-Timbral OFF

This turns off the Multi-Timbral capability. Only one MIDI channel will be active and only the sound currently selected will be heard when a MIDI signal is received.

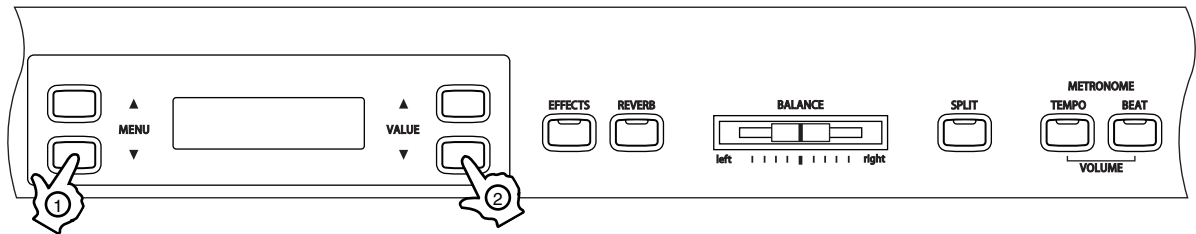

□ Step 1

Press the MENU buttons to select the Multi-Timbral Mode function.

```
19 Multi Timbre
= Off
```

OFF, ON1, or ON2 will be shown on the second line of the LCD screen.

□ Step 2

Press the VALUE buttons to turn the set Multi-Timbral Mode to OFF, ON1, or ON2.

□ Step 3

Press any one of the SOUND SELECT buttons to exit the menu.

- The Multi-Timbral Mode function will return to the default setting of 'OFF' each time the power is turned off.
- Use the USER MEMORY function (page 87), to save the desired Multi-Timbral Mode setting, allowing the current Multi-Timbral Mode setting to remain even after the power is turned off.
- When Multi-Timbral Mode is set to ON, sounds received via MIDI on the receive channels will all be played, even when split mode is active.

20) CHANNEL MUTE

This function determines which MIDI channels are activated to receive MIDI information when Multi-Timbral Mode is set to ON. Each of the 16 channels can be activated or deactivated individually.

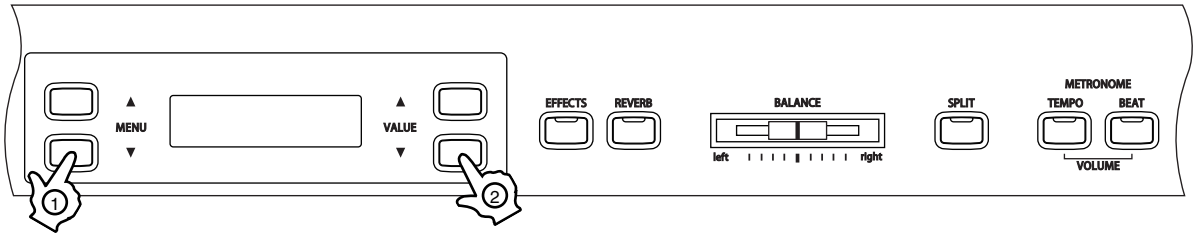

- **Step 1**
Press the MENU buttons to select the Channel Mute function.

The channel number and its Play/Mute status will be shown on the second line of the LCD screen.

```
20 Channel Mute
Channel 1= Play
```

↑↓ MENU button

```
20 Channel Mute
Channel 2= Play
```

↑↓

:

↑↓

```
20 Channel Mute
Channel 16= Play
```

↑↓

- **Step 2**
Press the VALUE buttons to set the Play/Mute status.

```
20 Channel Mute
Channel 1= Play
```

↑↓ VALUE button

```
20 Channel Mute
Channel 1= Mute
```

- **Step 3**
Press any one of the SOUND SELECT buttons to exit the menu.

- The Channel Mute function will return to the default settings of 'ON' each time the power is turned off.
- Use the USER MEMORY function (page 87), to save the desired Channel Mute settings, allowing the current Channel Mute settings to remain even after the power is turned off.

21) SENDING PROGRAM CHANGE NUMBERS

This function allows the CN43 piano to send program change numbers within the range of 1 to 128.

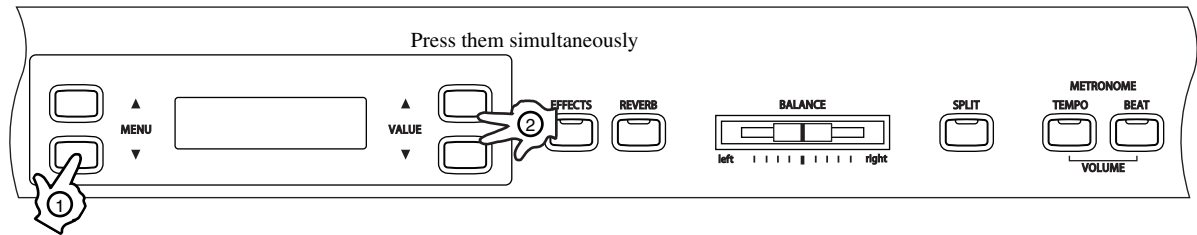

- Step 1**
 Press the MENU buttons to select the Send Program Change Number function.



```
21 Send PGM #
= 1 <UP+DOWN>
```

The Program Change Number will be shown on the second line of the LCD screen.
- Step 2**
 Press the VALUE buttons to set the desired Program Change Number.

The value can be set within the range of 1 to 128.
- Step 3**
 Press both VALUE buttons (▲▼) simultaneously to send the Program Change Number.
- Step 4**
 Press any one of the SOUND SELECT buttons to exit the menu.

22) MIDI CLOCK

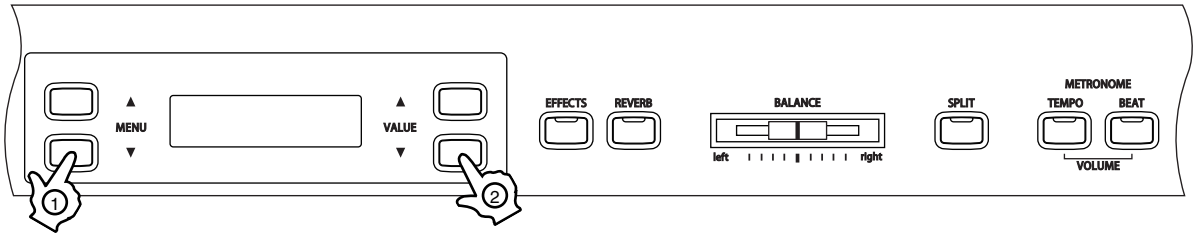
The MIDI Clock is the data code that MIDI instruments use as the reference for the tempo setting. When set to Internal, the CN43 piano uses its own built-in clock to control tempo settings. When set to External, the CN43 piano reads the clock data it receives via MIDI and uses this data to control the tempo.



- Step 1
Press the MENU buttons to select the MIDI Clock function.

The selected MIDI Clock source will be shown on the second line of the LCD screen.

- Step 2
Press the VALUE buttons to set the desired MIDI Clock setting.

```
22 MIDI Clock
= Int.
```

↑↓ VALUE button

- Step 3
Press any one of the SOUND SELECT buttons to exit the menu.

```
22 MIDI Clock
= Ext.
```

23) USER MEMORY

This function allows the CN43 piano to save user-definable settings which will be recalled every time the CN43 power is turned on.

The USER MEMORY function can be used to store Effect settings, Metronome settings (tempo, time signature and volume), starting sound, primary sound for each sound category and the menu functions 1 through 16 described in the previous pages.

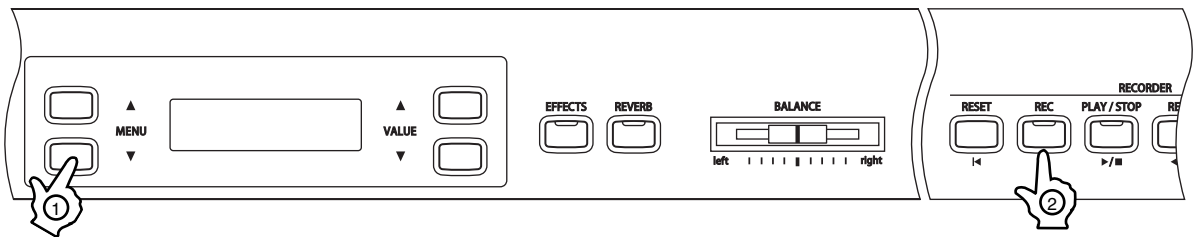

- Step 1
Press the MENU buttons to select the USER MEMORY function.

```
23 User Memory
Save +Press REC
```

- Step 2
Press the REC button to execute the save operation.

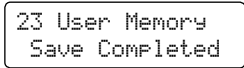

'Save Completed' be shown on the second line of the LCD screen.

- Step 3
Press any one of the SOUND SELECT buttons to exit the menu.

24) FACTORY RESET

This function will reset the CN43 piano to the default factory settings and is displayed only when the USER MEMORY function has been used. All parameters saved in the User Memory will be reset to the factory preset values.

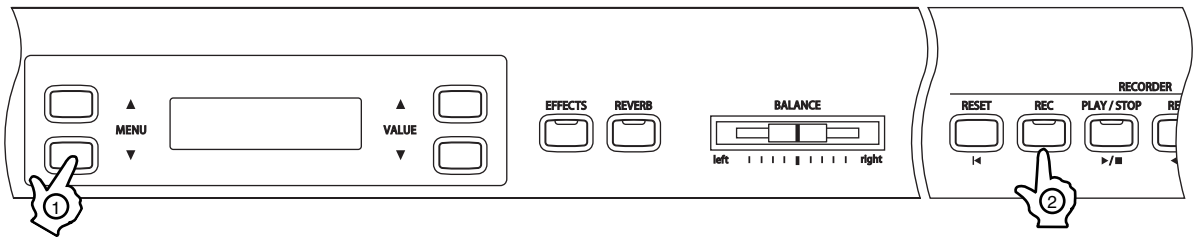

- Step 1
Press the MENU buttons to select the Factory Reset function.

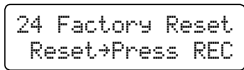

- Step 2
Press the REC button to restore factory settings, and exit the menu.

8. APPENDICES

◇ CONNECTING TO OTHER DEVICES

⚠ Caution • Do not directly connect the LINE IN and LINE OUT jacks of the CN43 together with a cable. An audio loop (oscillation sound) will occur, resulting in damage to the unit.

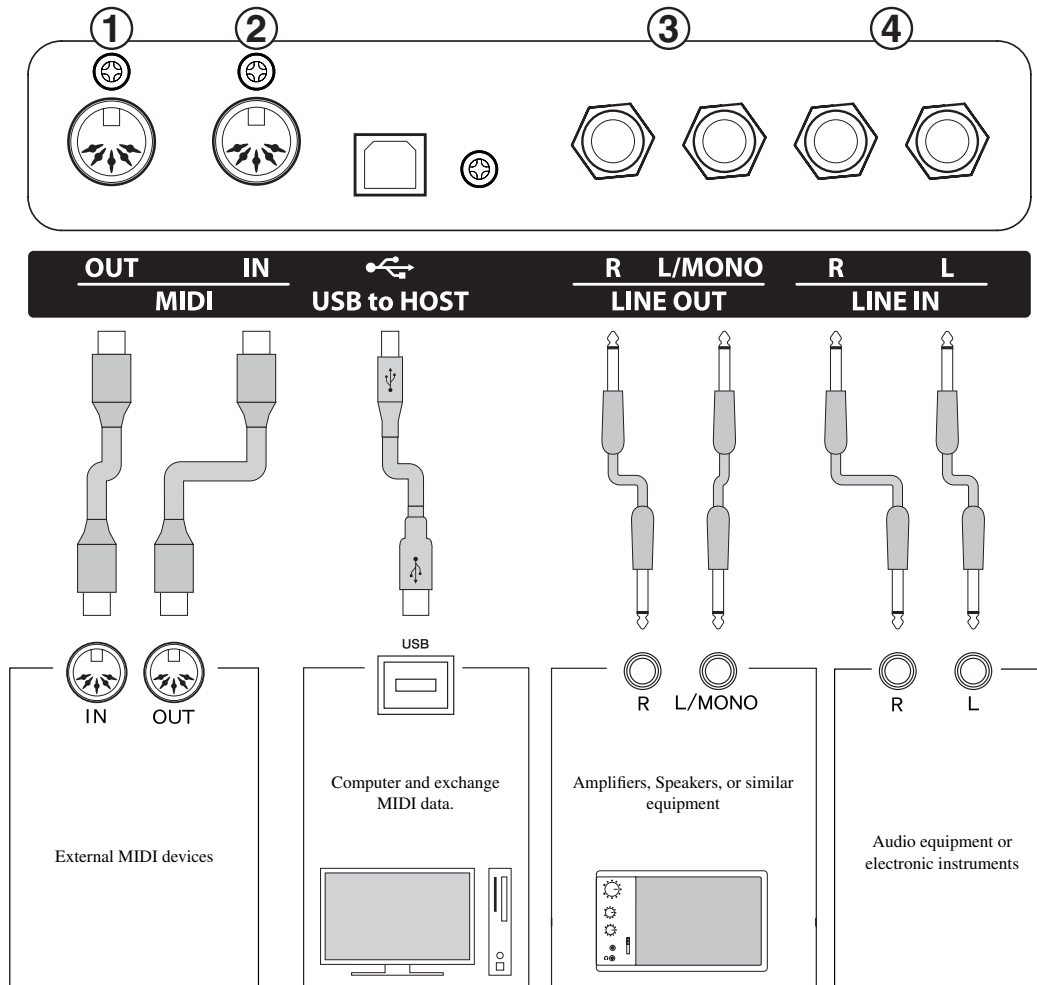

① MIDI JACKS

These jacks are used to connect external MIDI devices with the CN43 piano. There are three terminals: MIDI IN, MIDI OUT and MIDI THRU.

② USB to Host

This jack is used to connect with a personal computer and exchange MIDI data.

③ LINE OUT JACKS

These jacks provide stereo output of the CN43 piano's sound to amplifiers, tape recorders or similar equipment. The audio signal coming through the LINE IN jacks is also routed to these jacks. The CN43 piano's sound is mixed with the LINE IN signals.

The CN43 piano's VOLUME slider controls the output level of its own sound without affecting the level of the LINE IN signal.

④ LINE IN JACKS

These jacks are used to connect a pair of stereo outputs from other audio equipment or electronic instruments to the CN43 piano's speakers. The audio signal coming through these jacks bypasses the CN43 piano's volume control. To adjust the volume level, use the output control of the external device.

◇ USB MIDI

The CN43 digital piano features a 'USB to Host' type connector, allowing the instrument to be connected to a computer and utilised as a MIDI device. Depending on the type of computer and operating system installed, additional driver software may be required for USB MIDI communication to function correctly.

Operating System	USB MIDI Driver Support
Windows ME Windows XP (no SP, SP1, SP2, SP3) Windows XP 64-bit Windows Vista (SP1, SP2) Windows Vista 64-bit (SP1, SP2) Windows 7 Windows 7 64-bit	No additional USB MIDI driver software required. The standard (built-in) Windows USB MIDI driver will be installed automatically when the instrument is connected to the computer. After driver installation, ensure that the 'USB Audio Device' (Windows ME/Windows XP) or 'USB-MIDI' (Windows Vista/Windows 7) device is correctly selected in the application software.
Windows 98 SE Windows 2000 Windows Vista (no SP)	Additional USB MIDI driver software required. Please download the USB MIDI driver from the KAWAI website: ▶ http://www.kawai.co.jp/english After driver installation, ensure that the 'KAWAI USB MIDI' device is correctly selected in the application software.
Windows Vista 64-bit (no SP)	USB MIDI is not supported. Please upgrade to service pack 1 or service pack 2.
Mac OS X	No additional USB MIDI driver software required. The standard (built-in) Mac OS X USB MIDI driver will be installed automatically when the instrument is connected to the computer.
Mac OS 9	USB MIDI is not supported. Please use the standard MIDI IN/OUT connectors.

USB MIDI INFORMATION

- If the instrument's MIDI IN/OUT jacks and USB MIDI port are both connected simultaneously, the USB MIDI port will be given priority.
- Ensure that the instrument is turned off before attempting to connect the USB MIDI cable.
- When connecting the instrument to a computer using the USB MIDI port, there may be a short delay before communications begin.
- If the instrument is connected to a computer via a USB hub and USB MIDI communication becomes unreliable/unstable, please connect the USB MIDI cable directly to the one of the computer's USB ports.
- Disconnecting the USB MIDI cable suddenly, or turning the instrument on/off while using USB MIDI may cause computer instability in the following situations:
 - while installing the USB MIDI driver
 - while starting up the computer
 - while MIDI applications are performing tasks
 - while the computer is in energy saver mode
- If there are any further problems experienced with USB MIDI communication while the instrument is connected, please double-check all connections and relevant MIDI settings in the computer's operating system.

* 'MIDI' is a registered trademark of the Association of Manufacturers of Electronic Instruments (AMEI).

* 'Windows' is a registered trademark of Microsoft Corporation.

* 'Mac' and 'Mac OS' are registered trademarks of Apple Inc.

* Other company names and product names mentioned referenced herein may be registered trademarks or trademarks of respective owners.

◇ ASSEMBLY INSTRUCTIONS

- ⚠ Caution**
- Ensure that this instruction manual is read thoroughly before attempting to assemble the CN43 piano, and that two or more people work on assembly.
 - It may be necessary to tilt the unit by 90 degrees while assembling the CN43 piano. During this time, ensure that hands are not caught in the piano, keyboard lid, or score stand, and that the piano is not dropped on an individual's feet.

■ PARTS PROVIDED

Before attempting to assemble the CN43 piano unit, ensure that all parts are included. A Phillips-head screwdriver will also be required to assemble the unit (not included).

- (A) Piano (x 1)
- (B) Pedal board (x 1)
- (C) End panel (x 1 each for left and right)
- (D) Back panel (x 1)
- (E) Adjuster bolt (x 1)
- (F) Screw: $\phi 4 \times 16$ (x 4) (Silver)
- (G) Screw: $\phi 4 \times 20$ (x 4)
- (H) Screw: $\phi 4 \times 30$ (x 4)
- (I) Screw: M6 x 25 (x 4)
- (J) Cord clamp (x 2)
- (K) Headphone hook and screws (x 1 set)
- (L) Power cord (x 1)

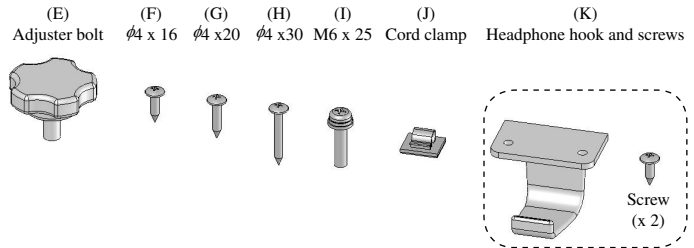

■ ASSEMBLY SEQUENCE

- ⚠ Caution**
- Be careful not to scratch or damage the floor, piano, or stand at the time of assembly.

1. Screw the adjuster bolt (E) into the threaded screw hole provided on the pedal.
2. From the side of the screw that is already on the backside of the pedal board (B), slide and insert the bracket of the end panel (C).
3. While pressing the end panel (C) against the pedal board (B), tighten the already-provided screws, one each on the left and right sides, and then tighten two screws (F) on each side.
4. Untie and pull out the pedal cable.
5. Set the back panel (D) and tighten the screws (G) (H) into the prepared holes. Loosely tighten the screws with the * symbol.

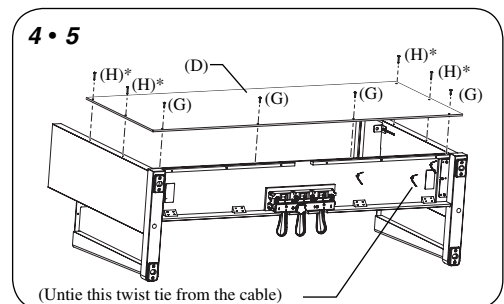
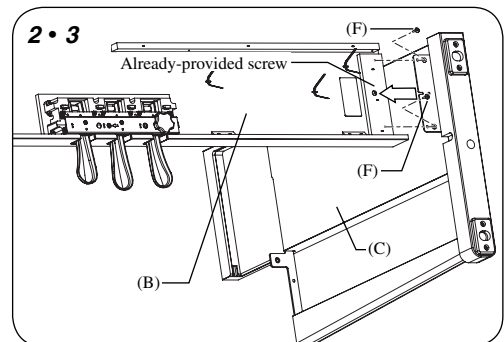
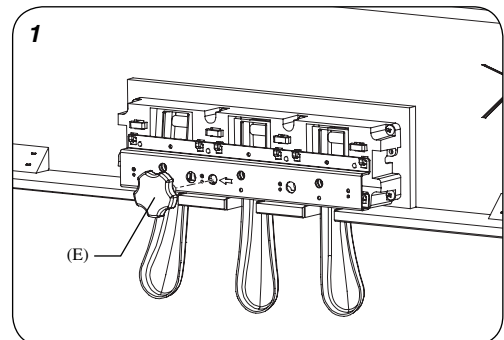

6. Place the stand so that the backside of the stand assembly rests against a wall, and then slowly and carefully insert the piano. Ensure that more than two people work on the assembly. If attempting to insert the piano without resting the stand against a wall, support the back of the stand using your foot or leg to prevent the stand from sliding backwards.

⚠ Caution • Ensure that the piano is not dropped on an individual's feet, and that fingers, hands and feet are not caught in the piano.

7. Press the end panel (C) of the stand to the piano (A), and then fasten the piano (A) to the stand with four screws (I).

⚠ Caution • Ensure that the piano and the stand are securely fastened together with the screws, preventing the possibility of the piano falling.

8. Fix the headphone hook and screws (K).
*If the headphone hook will not be required, it can be kept with the instruction manual.

9. Tightly fasten the loosely fastened screws (H) with the * symbol.

10. Insert the connector of the pedal cord into the receptacle, and fix the cord with the cord clamp (J) (make sure that the protrusion of the connector is facing the correct direction, and insert the connector straight).

11. Turn the adjuster bolt (E) at the bottom of the pedal stand until the bolt firmly touches the floor and supports the pedal board.

⚠ Caution • Ensure that the adjuster bolt (E) firmly touches the floor, supporting the pedal board and preventing damage. When moving the piano, remove the adjuster bolt (E) and readjust after moving has been completed.

12. Insert the power cord (L) into the piano.

13. Remove the protective film from the display.

Assembly is now complete.

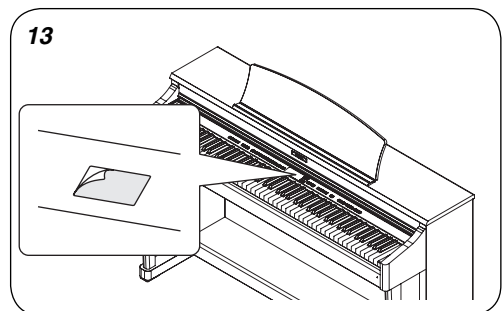
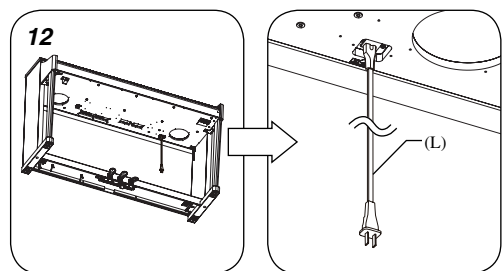
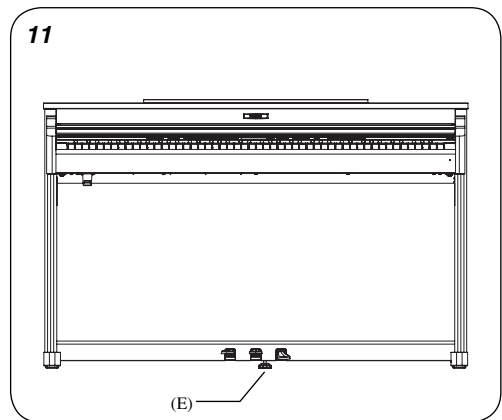
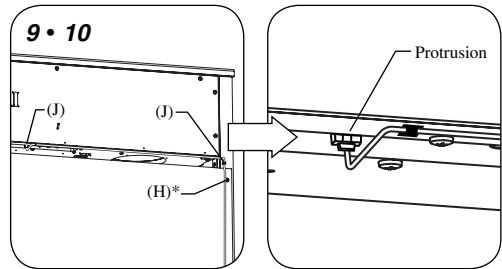
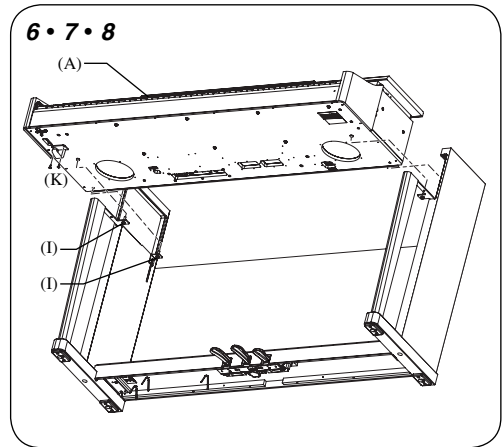

◇ PROGRAM CHANGE NUMBER MAPPING

Category	Sound	Multi-Timbral mode				
		Off, On 1		On 2		
		Bank LSB	Prog#	Bank MSB	Bank LSB	Prog#
PIANO1	Concert Grand	0	1	121	0	1
	Studio Grand	0	2	121	1	1
	Mellow Grand	0	3	121	2	1
	Modern Piano	0	4	121	0	2
PIANO2	Concert Grand 2	0	5	95	16	1
	Studio Grand 2	0	6	95	17	1
	Mellow Grand 2	0	7	95	18	1
	Rock Piano	0	8	121	1	2
ELECTRIC PIANO	Classic E.P.	0	9	121	0	5
	Modern E.P.	0	10	121	0	6
	60's E.P.	0	11	121	3	5
	Modern E.P. 2	0	12	121	1	6
DRAWBAR	Jazz Organ	0	13	121	0	18
	Drawbar Organ	0	14	121	0	17
	Drawbar Organ 2	0	15	121	1	17
	Be 3	0	16	95	2	17
CHURCH ORGAN	Church Organ	0	17	121	0	20
	Diapason	0	18	95	7	20
	Full Ensemble	0	19	95	1	21
	Diapason Oct.	0	20	95	6	20
HARPSI&MALLETS	Harpsichord	0	21	121	0	7
	Harpsichord 2	0	22	121	3	7
	Vibraphone	0	23	121	0	12
	Clavi	0	24	121	0	8
STRINGS	Slow Strings	0	25	95	1	45
	String Pad	0	26	95	8	49
	Warm Strings	0	27	95	1	49
	String Ensemble	0	28	121	0	49
CHOIR&PAD	Choir	0	29	121	0	53
	Choir 2	0	30	95	53	54
	New Age	0	31	121	0	89
	Atmosphere	0	32	121	0	100
BASS	Wood Bass	0	33	121	0	33
	Electric Bass	0	34	121	0	34
	Fretless Bass	0	35	121	0	36
	W. Bass & Ride	0	36	95	1	33
OTHERS:PIANO	Jazz Grand	0	37	95	8	1
	New Age Piano	0	38	95	9	1
	New Age Piano 2	0	39	95	10	1
	New Age Piano 3	0	40	95	11	1
	Piano Octaves	0	41	95	1	1
	Electric Grand	0	42	121	0	3
	Electric Grand2	0	43	121	1	3
	Honky Tonk	0	44	121	0	4
Wide Honky Tonk	0	45	121	1	4	

Category	Sound	Multi-Timbral mode				
		Off, On 1		On 2		
		Bank LSB	Prog#	Bank MSB	Bank LSB	Prog#
OTHERS:E.PIANO	Dolce E.P.	0	46	95	2	5
	Crystal E.P.	0	47	95	1	6
	Tremolo E.P.	0	48	95	1	5
	Classic E.P. 2	0	49	121	1	5
	Classic E.P. 3	0	50	121	2	5
	New Age E.P.	0	51	95	2	6
	Modern E.P. 3	0	52	121	2	6
	Legend E.P.	0	53	121	3	6
	Phase E.P.	0	54	121	4	6
OTHERS: HARPSI&MALLET	Harpsichord Oct	0	55	121	1	7
	WideHarpsichord	0	56	121	2	7
	Synth Clavi	0	57	121	1	8
	Celesta	0	58	121	0	9
	Glockenspiel	0	59	121	0	10
	Music Box	0	60	121	0	11
	Wide Vibraphone	0	61	121	1	12
	Marimba	0	62	121	0	13
	Wide Marimba	0	63	121	1	13
	Xylophone	0	64	121	0	14
	Handbells	0	65	95	1	15
	Tubular Bells	0	66	121	0	15
	Church Bells	0	67	121	1	15
	Carillon	0	68	121	2	15
Dulcimer	0	69	121	0	16	
OTHERS:DRAWBAR	Soft Solo	0	70	95	8	17
	Drawbar Organ 3	0	71	95	1	17
	Jazzier	0	72	95	1	18
	Hi-Lo	0	73	95	3	17
	Drawbar Organ 4	0	74	121	3	17
	ElectronicOrgan	0	75	95	9	17
	60's Organ	0	76	121	2	17
	Perc. Organ	0	77	121	1	18
	Perc. Organ 2	0	78	121	2	18
	Tibia Bass	0	79	95	14	18
	Rock Organ	0	80	121	0	19
OTHERS: CHURCH ORGAN	Principal Oct.	0	81	95	24	20
	Theater Organ	0	82	95	1	20
	8' Celeste	0	83	95	5	20
	Small Ensemble	0	84	95	8	20
	Reeds	0	85	95	10	20
	Chiffy Tibia	0	86	95	17	20
	Principal Pipe	0	87	95	22	20
	Church Organ 2	0	88	121	1	20
	Church Organ 3	0	89	121	2	20
	Reed Organ	0	90	121	0	21
	Puff Organ	0	91	121	1	21

Category	Sound	Multi-Timbral mode				
		Off, On 1		On 2		
		Bank LSB	Prog#	Bank MSB	Bank LSB	Prog#
OTHERS:ACCORDION	FrenchAccordion	0	92	121	0	22
	Fr. Accordion 2	0	93	95	1	22
	Accordion	0	94	121	1	22
	Accordion 2	0	95	95	2	22
	Blues Harmonica	0	96	95	2	23
	Harmonica	0	97	121	0	23
	Tango Accordion	0	98	121	0	24
OTHERS:GUITAR	FingerNylon Gtr	0	99	95	4	25
	Nylon Acoustic	0	100	121	0	25
	Nylon Acoustic2	0	101	121	2	25
	Nylon Acoustic3	0	102	121	3	25
	Ukulele	0	103	121	1	25
	Steel Guitar	0	104	121	0	26
	Steel Guitar 2	0	105	121	3	26
	12 String	0	106	121	1	26
	Mandolin	0	107	121	2	26
	Ballad Guitar	0	108	95	6	26
	Jazz Guitar	0	109	121	0	27
	Modern Jazz Gtr	0	110	95	10	27
	Pedal Steel	0	111	121	1	27
	Rhythm Guitar	0	112	121	2	28
	Electric Guitar	0	113	121	0	28
	E. Guitar 2	0	114	121	1	28
	E. Guitar 3	0	115	121	2	29
	Cutting Guitar	0	116	95	3	28
	Cutting Guitar2	0	117	121	1	29
	Cutting Guitar3	0	118	95	5	28
	Muted Electric	0	119	121	0	29
	Country Lead	0	120	121	3	29
	OverdriveGuitar	0	121	121	0	30
	Dynmic Ov.drive	0	122	121	1	30
	Distortion	0	123	121	0	31
	Dist Feedback	0	124	121	1	31
	Dist Rhythm	0	125	121	2	31
	E.Gtr Harmonics	0	126	121	0	32
	Guitar Feedback	0	127	121	1	32
	OTHERS:BASS	Wood Bass 2	0	128	95	2
Wood Bass 3		1	1	95	4	33
Wood Bass 4		1	2	95	5	33
Electric Bass 2		1	3	95	5	34
Electric Bass 3		1	4	95	6	34
FingerSlap Bass		1	5	121	1	34
Pick Bass		1	6	121	0	35
Slap Bass		1	7	121	0	37
Slap Bass 2		1	8	121	0	38

Category	Sound	Multi-Timbral mode				
		Off, On 1		On 2		
		Bank LSB	Prog#	Bank MSB	Bank LSB	Prog#
OTHERS:BASS	Synth Bass	1	9	121	0	39
	Synth Bass 2	1	10	121	0	40
	Synth Bass 3	1	11	121	2	39
	Synth Bass 4	1	12	121	1	40
	Warm Synth Bass	1	13	121	1	39
	Clavi Bass	1	14	121	3	39
	Hammer Bass	1	15	121	4	39
	Rubber Bass	1	16	121	2	40
	Attack Bass	1	17	121	3	40
OTHERS: STRINGS&ORCHINST	Violin	1	18	121	0	41
	Slow Violin	1	19	121	1	41
	Viola	1	20	121	0	42
	Cello	1	21	121	0	43
	Contrabass	1	22	121	0	44
	Tremolo Strings	1	23	121	0	45
	Strings & Brass	1	24	121	1	49
	60's Strings	1	25	121	2	49
	Strings sf.	1	26	95	9	49
	StringEnsemble2	1	27	121	0	50
	Synth Strings	1	28	121	0	51
	Synth Strings 2	1	29	121	0	52
	Synth Strings 3	1	30	121	1	51
	Pizzicato	1	31	121	0	46
	Harp	1	32	121	0	47
	Celtic Harp	1	33	121	1	47
	Timpani	1	34	121	0	48
OTHERS:CHOIR&HIT	Choir 3	1	35	121	1	53
	Voice Oohs	1	36	121	0	54
	Humming	1	37	121	1	54
	Synth Vocal	1	38	121	0	55
	Analog Voice	1	39	121	1	55
	Orchestra Hit	1	40	121	0	56
	Bass Hit Plus	1	41	121	1	56
	6th Hit	1	42	121	2	56
	Euro Hit	1	43	121	3	56
OTHERS:BRASS	Trumpet	1	44	121	0	57
	Solo Trumpet	1	45	121	1	57
	Flugel Horn	1	46	95	1	57
	SentimentalBone	1	47	95	7	58
	Trombone	1	48	121	0	58
	Trombone 2	1	49	121	1	58
	Bright Trombone	1	50	121	2	58
	Tuba	1	51	121	0	59
	CupMute Trumpet	1	52	95	1	60
	CupMuteTrombone	1	53	95	2	60
	Muted Trumpet	1	54	121	0	60
	Muted Trumpet 2	1	55	121	1	60

Category	Sound	Multi-Timbral mode				
		Off, On 1		On 2		
		Bank LSB	Prog#	Bank MSB	Bank LSB	Prog#
OTHERS:BRASS	French Horns	1	56	121	0	61
	Warm FrenchHorn	1	57	121	1	61
	Brass Section	1	58	121	0	62
	Brass Section 2	1	59	121	1	62
	Synth Brass	1	60	121	0	63
	Synth Brass 2	1	61	121	0	64
	Synth Brass 3	1	62	121	1	63
	Synth Brass 4	1	63	121	1	64
	Jump Brass	1	64	121	3	63
	Analog Brass	1	65	121	2	63
	Analog Brass 2	1	66	121	2	64
	OTHERS:REED	Oboe & Strings	1	67	95	5
Soprano Sax		1	68	121	0	65
Alto Sax		1	69	121	0	66
Soft Tenor Sax		1	70	95	2	67
Tenor Sax		1	71	121	0	67
Baritone Sax		1	72	121	0	68
Oboe		1	73	121	0	69
English Horn		1	74	121	0	70
Bassoon		1	75	121	0	71
Clarinet		1	76	121	0	72
OTHERS:PIPE		Flute & Strings	1	77	95	8
	Piccolo	1	78	121	0	73
	Jazz Flute	1	79	95	1	74
	Big Band Winds	1	80	95	2	74
	OrchestralWinds	1	81	95	3	74
	Flute	1	82	121	0	74
	Ballad Flute	1	83	95	13	74
	Recorder	1	84	121	0	75
	Pan Flute	1	85	121	0	76
	Blown Bottle	1	86	121	0	77
	Shakuhachi	1	87	121	0	78
	Whistle	1	88	121	0	79
	Ocarina	1	89	121	0	80
OTHERS:SYNTH LEAD	Square	1	90	121	0	81
	Square 2	1	91	121	1	81
	Sine	1	92	121	2	81
	Classic Synth	1	93	121	0	82
	Classic Synth 2	1	94	121	1	82
	Lead	1	95	121	2	82
	Classic Synth 3	1	96	121	3	82
	SequencedAnalog	1	97	121	4	82
	Caliope	1	98	121	0	83
	Chiff	1	99	121	0	84
	Charang	1	100	121	0	85
	Wire Lead	1	101	121	1	85
Voice	1	102	121	0	86	

Category	Sound	Multi-Timbral mode				
		Off, On 1		On 2		
		Bank LSB	Prog#	Bank MSB	Bank LSB	Prog#
OTHERS:SYNTH LEAD	Fifth	1	103	121	0	87
	Bass & Lead	1	104	121	0	88
	Soft Wire Lead	1	105	121	1	88
OTHERS:SYNTH PAD	Itopia	1	106	121	1	92
	New Age 2	1	107	95	1	89
	New Age 3	1	108	95	2	89
	New Age 4	1	109	95	3	89
	Warm Pad	1	110	121	0	90
	Sine Pad	1	111	121	1	90
	Bright Warm Pad	1	112	95	1	90
	Polysynth	1	113	121	0	91
	Choir	1	114	121	0	92
	Bowed	1	115	121	0	93
	Metallic	1	116	121	0	94
	Halo	1	117	121	0	95
	Sweep	1	118	121	0	96
	Multi Sweep	1	119	95	1	96
	OTHERS:SYNTH SFX	Rain Pad	1	120	121	0
Soundtrack		1	121	121	0	98
Crystal		1	122	121	0	99
Synth Mallet		1	123	121	1	99
Brightness		1	124	121	0	101
Brightness 2		1	125	95	1	101
Goblin		1	126	121	0	102
Echoes		1	127	121	0	103
Echo Bell		1	128	121	1	103
Echo Pan		2	1	121	2	103
Sci-Fi		2	2	121	0	104
OTHERS:ETHNIC	Sitar	2	3	121	0	105
	Sitar 2	2	4	121	1	105
	Banjo	2	5	121	0	106
	Shamisen	2	6	121	0	107
	Koto	2	7	121	0	108
	Taisho Koto	2	8	121	1	108
	Kalimba	2	9	121	0	109
	Bag Pipe	2	10	121	0	110
	Fiddle	2	11	121	0	111
	Shanai	2	12	121	0	112
OTHERS:PERCUSSION	Tinkle Bell	2	13	121	0	113
	Agogo	2	14	121	0	114
	Steel Drums	2	15	121	0	115
	Woodblock	2	16	121	0	116
	Castanet	2	17	121	1	116
	Taiko Drums	2	18	121	0	117
	Concert BD	2	19	121	1	117
	Melodic Toms	2	20	121	0	118
	Melodic Toms 2	2	21	121	1	118

Category	Sound	Multi-Timbral mode				
		Off, On 1		On 2		
		Bank LSB	Prog#	Bank MSB	Bank LSB	Prog#
OTHERS:PERCUSSION	Synth Drum	2	22	121	0	119
	Rhythm Box Tom	2	23	121	1	119
	Electric Drum	2	24	121	2	119
	Reverse Cymbal	2	25	121	0	120
	Gtr Fret Noise	2	26	121	0	121
	GtrCuttingNoise	2	27	121	1	121
	CuttingNoise 2	2	28	95	1	121
Ac Bass Slap	2	29	121	2	121	
OTHERS:SFX	Breath Noise	2	30	121	0	122
	Flute Key Click	2	31	121	1	122
	Seashore	2	32	121	0	123
	Rain	2	33	121	1	123
	Thunder	2	34	121	2	123
	Wind	2	35	121	3	123
	Stream	2	36	121	4	123
	Bubble	2	37	121	5	123
	Bird Tweet	2	38	121	0	124
	Dog Barking	2	39	121	1	124
	Horse Gallop	2	40	121	2	124
	Bird Tweet 2	2	41	121	3	124
	Telephone	2	42	121	0	125
	Telephone 2	2	43	121	1	125
	Door Creak	2	44	121	2	125
	Door Slam	2	45	121	3	125
	Scratch	2	46	121	4	125
	Wind Chime	2	47	121	5	125
	Helicopter	2	48	121	0	126
	Car Engine	2	49	121	1	126
	Car Stopping	2	50	121	2	126
	Car Passing	2	51	121	3	126
	Car Crash	2	52	121	4	126
	Siren	2	53	121	5	126
	Train	2	54	121	6	126
	Jet Plane	2	55	121	7	126
	Starship	2	56	121	8	126
	Burst Noise	2	57	121	9	126
	Applause	2	58	121	0	127
	Laughing	2	59	121	1	127
	Screaming	2	60	121	2	127
	Punch	2	61	121	3	127
	Heartbeat	2	62	121	4	127
Foot Step	2	63	121	5	127	
Gunshot	2	64	121	0	128	
Machine Gun	2	65	121	1	128	
Laser Gun	2	66	121	2	128	
Explosion	2	67	121	3	128	

Category	Sound	Multi-Timbral mode				
		Off, On 1		On 2		
		Bank LSB	Prog#	Bank MSB	Bank LSB	Prog#
OTHERS:DRUMKIT	Standard Set	2	68	120	0	1
	Room Set	2	69	120	0	9
	Power Set	2	70	120	0	17
	Electronic Set	2	71	120	0	25
	Analog Set	2	72	120	0	26
	Jazz Set	2	73	120	0	33
	Brush Set	2	74	120	0	41
	Orchestra Set	2	75	120	0	49
	SFX Set	2	76	120	0	57
	Ambience Set	2	77	120	0	1
	Platinum Set	2	78	120	0	1
	Ballad Set	2	79	120	0	1

*1

*2

*3

*1 Exclusive message (F0, 40, 7F, 33, 04, 08, 10, ch, 7F, 02, F7) is required after the Program Change message.
 *2 Exclusive message (F0, 40, 7F, 33, 04, 08, 10, ch, 7F, 04, F7) is required after the Program Change message.
 *3 Exclusive message (F0, 40, 7F, 33, 04, 08, 10, ch, 7F, 05, F7) is required after the Program Change message.
 'ch' is the MIDI channel number (00~0F)

◇ DRUM SOUND MAPPING

	Standard Set	Room Set	Power Set	Electronic Set
	C#			
	D			
	D#	High Q	High Q	High Q
	E	Slap	Slap	Slap
	F	Scratch Push	Scratch Push	Scratch Push
	F#	Scratch Pull	Scratch Pull	Scratch Pull
	G	Sticks	Sticks	Sticks
	G#	Square Click	Square Click	Square Click
	A	Metronome Click	Metronome Click	Metronome Click
	A#	Metronome Bell	Metronome Bell	Metronome Bell
	B	Acoustic Bass Drum	Acoustic Bass Drum	Acoustic Bass Drum
C1	C	Bass Drum 1	Power Kick Drum	Electric Bass Drum
	C#	Side Stick	Side Stick	Side Stick
	D	Acoustic Snare	Power Snare Drum	Electric Snare 1
	D#	Hand Clap	Hand Clap	Hand Clap
	E	Electric Snare	Electric Snare	Electric Snare 2
	F	Low Floor Tom	Power Low Tom 2	Electric Low Tom 2
	F#	Closed Hi-hat	Closed Hi-hat	Closed Hi-hat
	G	High Floor Tom	Power Low Tom 1	Electric Low Tom 1
	G#	Pedal Hi-hat	Pedal Hi-hat	Pedal Hi-hat
	A	Low Tom	Power Mid Tom 2	Electric Mid Tom 2
	A#	Open Hi-hat	Open Hi-hat	Open Hi-hat
	B	Low-Mid Tom	Power Mid Tom 1	Electric Mid Tom 1
C2	C	High-Mid Tom	Power Hi Tom 2	Electric Hi Tom 2
	C#	Crash Cymbal 1	Crash Cymbal 1	Crash Cymbal 1
	D	Hi Tom	Power Hi Tom 1	Electric Hi Tom 1
	D#	Ride Cymbal 1	Ride Cymbal 1	Ride Cymbal 1
	E	Chinese Cymbal	Chinese Cymbal	Reverse Cymbal
	F	Ride Bell	Ride Bell	Ride Bell
	F#	Tambourine	Tambourine	Tambourine
	G	Splash Cymbal	Splash Cymbal	Splash Cymbal
	G#	Cowbell	Cowbell	Cowbell
	A	Crash Cymbal 2	Crash Cymbal 2	Crash Cymbal 2
	A#	Vibra-slap	Vibra-slap	Vibra-slap
	B	Ride Cymbal 2	Ride Cymbal 2	Ride Cymbal 2
C3	C	High Bongo	High Bongo	High Bongo
	C#	Low Bongo	Low Bongo	Low Bongo
	D	Mute Hi Conga	Mute Hi Conga	Mute Hi Conga
	D#	Open Hi Conga	Open Hi Conga	Analog Mid Conga
	E	Low Conga	Low Conga	Analog Low Conga
	F	High Timbale	High Timbale	High Timbale
	F#	Low Timbale	Low Timbale	Low Timbale
	G	High Agogo	High Agogo	High Agogo
	G#	Low Agogo	Low Agogo	Low Agogo
	A	Cabasa	Cabasa	Cabasa
	A#	Maracas	Maracas	Maracas
	B	Short Whistle	Short Whistle	Short Whistle
C4	C	Long Whistle	Long Whistle	Long Whistle
	C#	Short Guiro	Short Guiro	Short Guiro
	D	Long Guiro	Long Guiro	Long Guiro
	D#	Claves	Claves	Claves
	E	Hi Wood Block	Hi Wood Block	Hi Wood Block
	F	Low Wood Block	Low Wood Block	Low Wood Block
	F#	Mute Cuica	Mute Cuica	Mute Cuica
	G	Open Cuica	Open Cuica	Open Cuica
	G#	Mute Triangle	Mute Triangle	Mute Triangle
	A	Open Triangle	Open Triangle	Open Triangle
	A#	Shaker	Shaker	Shaker
	B	Jingle Bell	Jingle Bell	Jingle Bell
C5	C	Bell Tree	Bar Chimes	Bar Chimes
	C#	Castanets	Castanets	Castanets
	D	Mute Surdo	Mute Surdo	Mute Surdo
	D#	Open Surdo	Open Surdo	Open Surdo
	E			

	Analog Set	Jazz Set	Brush Set	Orchestra Set
	C#			
	D			
	D#	High Q	High Q	Closed Hi-hat 2
	E	Slap	Slap	Pedal Hi-hat
	F	Scratch Push	Scratch Push	Open Hi-hat 2
	F#	Scratch Pull	Scratch Pull	Ride Cymbal 1
	G	Sticks	Sticks	Sticks
	G#	Square Click	Square Click	Square Click
	A	Metronome Click	Metronome Click	Metronome Click
	A#	Metronome Bell	Metronome Bell	Metronome Bell
	B	Acoustic Bass Drum	Jazz Kick 2	Concert BD 2
C1	C	Analog Bass Drum	Jazz Kick 1	Concert BD 1
	C#	Analog Rim Shot	Side Stick	Side Stick
	D	Analog Snare 1	Acoustic Snare	Concert SD
	D#	Hand Clap	Hand Clap	Castanets
	E	Electric Snare	Electric Snare	Concert SD
	F	Analog Low Tom 2	Low Floor Tom	Timpani F
	F#	Analog CHH 1	Closed Hi-hat	Timpani F#
	G	Analog Low Tom 1	High Floor Tom	Timpani G
	G#	Analog CHH 2	Pedal Hi-hat	Timpani G#
	A	Analog Mid Tom 2	Low Tom	Timpani A
	A#	Analog OHH	Open Hi-hat	Timpani A#
	B	Analog Mid Tom 1	Low-Mid Tom	Timpani B
C2	C	Analog Hi Tom 2	High-Mid Tom	Timpani c
	C#	Analog Cymbal	Crash Cymbal 1	Timpani c#
	D	Analog Hi Tom 1	Hi Tom	Timpani d
	D#	Ride Cymbal 1	Ride Cymbal 1	Timpani d#
	E	Chinese Cymbal	Chinese Cymbal	Timpani e
	F	Ride Bell	Ride Bell	Timpani f
	F#	Tambourine	Tambourine	Tambourine
	G	Splash Cymbal	Splash Cymbal	Splash Cymbal
	G#	Analog Cowbell	Cowbell	Cowbell
	A	Crash Cymbal 2	Crash Cymbal 2	Concert Cymbal 2
	A#	Vibra-slap	Vibra-slap	Vibra-slap
	B	Ride Cymbal 2	Ride Cymbal 2	Concert Cymbal 1
C3	C	High Bongo	High Bongo	High Bongo
	C#	Low Bongo	Low Bongo	Low Bongo
	D	Analog Hi Conga	Mute Hi Conga	Mute Hi Conga
	D#	Analog Mid Conga	Open Hi Conga	Open Hi Conga
	E	Analog Low Conga	Low Conga	Low Conga
	F	High Timbale	High Timbale	High Timbale
	F#	Low Timbale	Low Timbale	Low Timbale
	G	High Agogo	High Agogo	High Agogo
	G#	Low Agogo	Low Agogo	Low Agogo
	A	Cabasa	Cabasa	Cabasa
	A#	Analog Maracas	Maracas	Maracas
	B	Short Whistle	Short Whistle	Short Whistle
C4	C	Long Whistle	Long Whistle	Long Whistle
	C#	Short Guiro	Short Guiro	Short Guiro
	D	Long Guiro	Long Guiro	Long Guiro
	D#	Analog Claves	Claves	Claves
	E	Hi Wood Block	Hi Wood Block	Hi Wood Block
	F	Low Wood Block	Low Wood Block	Low Wood Block
	F#	Mute Cuica	Mute Cuica	Mute Cuica
	G	Open Cuica	Open Cuica	Open Cuica
	G#	Mute Triangle	Mute Triangle	Mute Triangle
	A	Open Triangle	Open Triangle	Open Triangle
	A#	Shaker	Shaker	Shaker
	B	Jingle Bell	Jingle Bell	Jingle Bell
C5	C	Bar Chimes	Bar Chimes	Bar Chimes
	C#	Castanets	Castanets	Castanets
	D	Mute Surdo	Mute Surdo	Mute Surdo
	D#	Open Surdo	Open Surdo	Open Surdo
	E			Applause

	SFX Set	Ambience Set	Platinum Set	Ballad Set
	C#	Snare Roll	Snare Roll	Snare Roll
	D	Finger Snap	Finger Snap	Finger Snap
	D#	High Q	High Q	High Q
	E	Slap	Slap	Slap
	F	Scratch Push	Scratch Push	Scratch Push
	F#	Scratch Pull	Scratch Pull	Scratch Pull
	G	Sticks	Sticks	Sticks
	G#	Square Click	Square Click	Square Click
	A	Metronome Click	Metronome Click	Metronome Click
	A#	Metronome Bell	Metronome Bell	Metronome Bell
	B	Ambi BD2	Plat BD2	Bala BD2
C1	C	Ambi BD1	Plat BD1	Bala BD1
	C#	Ambi Rim	Plat Rim	Plat Rim
	D	Ambi SD1	Plat SD1	Bala SD1
	D#	Ambi Clap	Ambi Clap	Ambi Clap
	E	Ambi SD2	Plat SD2	Bala SD2
	F	AmbiLowTom2	FunkLowTom2	FunkLowTom2
	F#	Ambi HHC	Funk HHC	Funk HHC
	G	AmbiLowTom1	FunkLowTom1	FunkLowTom1
	G#	Ambi HHP	Funk HHP	Funk HHP
	A	AmbiMidTom2	FunkMidTom2	FunkMidTom2
	A#	Ambi HHO	Funk HHO	Funk HHO
	B	AmbiMidTom1	FunkMidTom1	FunkMidTom1
C2	C	AmbiHiTom2	FunkHiTom2	FunkHiTom2
	C#	Ambi Crash1	Funk Crash1	Ambi Crash1
	D	AmbiHiTom1	FunkHiTom1	FunkHiTom1
	D#	Ambi Ride1	Ambi Ride1	Ambi Ride1
	E	Chinese Cymbal	Chinese Cymbal	Chinese Cymbal
	F	Ambi Cup	Ambi Cup	Ambi Cup
	F#	Tambourlne	Tambourlne	Tambourlne
	G	Funk Splash	Funk Splash	Funk Splash
	G#	Cowbell	Cowbell	Cowbell
	A	Funk Crash2	Funk Crash2	Funk Crash2
	A#	Vibra slap	Vibra slap	Vibra slap
	B	Ambi Ride2	Ambi Ride2	Ambi Ride2
C3	C	Hi Bongo	Hi Bongo	Hi Bongo
	C#	Low Bongo	Low Bongo	Low Bongo
	D	Mute Hi Conga	Mute Hi Conga	Mute Hi Conga
	D#	Hi Conga	Hi Conga	Hi Conga
	E	Low Conga	Low Conga	Low Conga
	F	Hi Timbale	Hi Timbale	Hi Timbale
	F#	Low Timbale	Low Timbale	Low Timbale
	G	Hi Agogo	Hi Agogo	Hi Agogo
	G#	Low Agogo	Low Agogo	Low Agogo
	A	Cabasa	Cabasa	Cabasa
	A#	Maracas	Maracas	Maracas
	B	Short Whistle	Short Whistle	Short Whistle
C4	C	Long Whistle	Long Whistle	Long Whistle
	C#	Short Guiro	Short Guiro	Short Guiro
	D	Long Guiro	Long Guiro	Long Guiro
	D#	Claves	Claves	Claves
	E	Hi Wood Blk	Hi Wood Blk	Hi Wood Blk
	F	Low Wood Blk	Low Wood Blk	Low Wood Blk
	F#	Mute Cuica	Mute Cuica	Mute Cuica
	G	Open Cuica	Open Cuica	Open Cuica
	G#	Mute Triangle	Mute Triangle	Mute Triangle
	A	Open Triangle	Open Triangle	Open Triangle
	A#	Shaker	Shaker	Shaker
	B	Jingle Bell	Jingle Bell	Jingle Bell
C5	C	Bar Chimes	Bar Chimes	Bar Chimes
	C#	Castanets	Castanets	Castanets
	D	Mute Surdo	Mute Surdo	Mute Surdo
	D#	Open Surdo	Open Surdo	Open Surdo
	E			

◇ RHYTHM SECTION STYLE LIST

Genre	Display	Style Name	Genre	Display	Style Name
16th Swing	FnkShuffle1	Funk Shuffle 1	8th Straight	8Beat1	8 Beat 1
	FnkShuffle2	Funk Shuffle 2		8Beat2	8 Beat 2
	HipHop1	Hip Hop 1		SmoothBeat	Smooth Beat
	HipHop2	Hip Hop 2		Pop1	Pop 1
	HipHop3	Hip Hop 3		Pop2	Pop 2
	HipHop4	Hip Hop 4		RideBeat	Ride Beat
	16Shuffle1	16 Shuffle 1		SlipBeat	Slip Beat
	16Shuffle2	16 Shuffle 2		8th Rock	JazzRock
16Shuffle3	16 Shuffle 3	8Beat3	8 Beat 3		
16th Funk	FunkyBeat1	Funky Beat 1	RockBeat1		Rock Beat 1
	FunkyBeat2	Funky Beat 2	RockBeat2		Rock Beat 2
	FunkyBeat3	Funky Beat 3	RockBeat3		Rock Beat 3
	Funk1	Funk 1	RockBeat4		Rock Beat 4
	Funk2	Funk 2	Blues/Rock		Blues/Rock
	Funk3	Funk 3	HeavyBeat		Heavy Beat
16th Straight	JazzFunk	Jazz Funk	HardRock		Hard Rock
	16Beat1	16 Beat 1	SurfRock		Surf Rock
	16Beat2	16 Beat 2	R&B	R&B	
	16Beat3	16 Beat 3	8th Swing	Motown1	Motown 1
	16Beat4	16 Beat 4		FastShuffle	8th Fast Shuffle
	RimBeat	Rim Beat		Motown2	Motown 2
	RollBeat	Roll Beat		GsplShuffle	Gospel Shuffle
	LightRide1	Light Ride 1		Ragtime	Ragtime
DixieRock	Dixie Rock	Cntry2Beat		Country 2 Beat	
16th Latin	SurdoSamba	Surdo Samba	Triplet/Waltz	TrpltRock1	Triplet Rock 1
	LatinGroove	Latin Groove		TrpltRock2	Triplet Rock 2
	LightSamba	Light Samba		Bembe	Bembe
	Songo	Songo		RockShuffle	Rock Shuffle
	Samba	Samba		Boogie	Boogie
	Merenge	Merenge		Triplet1	Triplet 1
16th Dance/Techno	FunkyBeat4	Funky Beat 4		Triplet2	Triplet 2
	16Beat5	16 Beat 5		Reggae	Reggae
	Disco1	Disco 1		GsplBallad	Gospel Ballad
	Disco2	Disco 2		Waltz	Waltz
	Techno1	Techno 1		H.H.Swing	H.H. Swing
	Techno2	Techno 2		RideSwing	Ride Swing
	Techno3	Techno 3		Fast4Beat	Fast 4 Beat
	HeavyDance	Heavy Dance		AfroCuban	Afro Cuban
16th Ballad	Ballad1	Ballad 1	JazzWaltz1	Jazz Waltz 1	
	Ballad2	Ballad 2	JazzWaltz2	Jazz Waltz 2	
	Ballad3	Ballad 3	5/4Swing	5/4 Swing	
	Ballad4	Ballad 4	Latin	H.H.Bossa	H.H. Bossa Nova
	Ballad5	Ballad 5		RideBossa	Ride Bossa Nova
	LightRide2	Light Ride 2		Beguine	Beguine
	ElectroPop1	Electro Pop 1		Mambo	Mambo
	ElectroPop2	Electro Pop 2		ChaCha	Cha Cha
	16Shuffle4	16 Shuffl e 4		Tango	Tango
	8th Ballad	SlowJam		Slow Jam	Habanera
SlowRock		Slow Rock			
R&B Ballad		R&B Ballad			
50'sTriplet		Triplet 50's Ballad			
R&BTripLet		Triplet R&B Ballad			

◇ RHYTHM SECTION CHORD TYPES

The following is a list of chord types recognised by the CN43 digital piano Rhythm Section. Each chord can be played by pressing the notes marked with a ● symbol in the diagrams below. In addition, the common Major, Minor, M7, and 7, chord types can also be played by pressing just the notes marked with a ★ symbol.

Chord Name	Notes	Chord Name	Notes	Chord Name	Notes
C Maj		D ^b Maj (C [#])		D Maj	
C sus4		D ^b sus4 (C [#])		D sus4	
C aug		D ^b aug (C [#])		D aug	
C min		D ^b min (C [#])		D min	
C M7		D ^b M7 (C [#])		D M7	
C 6		D ^b 6 (C [#])		D 6	
C m7		D ^b m7 (C [#])		D m7	
C mM7		D ^b mM7 (C [#])		D mM7	
C m6		D ^b m6 (C [#])		D m6	
C 7		D ^b 7 (C [#])		D 7	
C 7 ⁽⁵⁾		D ^b 7 ⁽⁵⁾ (C [#])		D 7 ⁽⁵⁾	
C 7 ^(#5)		D ^b 7 ^(#5) (C [#])		D 7 ^(#5)	
C 7sus4		D ^b 7sus4 (C [#])		D 7sus4	
C m7 ⁽⁵⁾		D ^b m7 ⁽⁵⁾ (C [#])		D m7 ⁽⁵⁾	
C dim		D ^b dim (C [#])		D dim	
C others		D ^b others (C [#])		D others	

Chord Name	Notes	Chord Name	Notes	Chord Name	Notes
E^b Maj (D [#])		E Maj		F Maj	
E^b sus4 (D [#])		E sus4		F sus4	
E^b aug (D [#])		E aug		F aug	
E^b min (D [#])		E min		F min	
E^b M7 (D [#])		E M7		F M7	
E^b 6 (D [#])		E 6		F 6	
E^b m7 (D [#])		E m7		F m7	
E^b mM7 (D [#])		E mM7		F mM7	
E^b m6 (D [#])		E m6		F m6	
E^b 7 (D [#])		E 7		F 7	
E^b 7⁽⁻⁵⁾ (D [#])		E 7⁽⁻⁵⁾		F 7⁽⁻⁵⁾	
E^b 7^(#5) (D [#])		E 7^(#5)		F 7^(#5)	
E^b 7sus4 (D [#])		E 7sus4		F 7sus4	
E^b m7⁽⁻⁵⁾ (D [#])		E m7⁽⁻⁵⁾		F m7⁽⁻⁵⁾	
E^b dim (D [#])		E dim		F dim	
E^b others (D [#])		E others		F others	

Chord Name	Notes	Chord Name	Notes	Chord Name	Notes
G ^b Maj (F [#])		G Maj		A ^b Maj (G [#])	
G ^b sus4 (F [#])		G sus4		A ^b sus4 (G [#])	
G ^b aug (F [#])		G aug		A ^b aug (G [#])	
G ^b min (F [#])		G min		A ^b min (G [#])	
G ^b M7 (F [#])		G M7		A ^b M7 (G [#])	
G ^b 6 (F [#])		G 6		A ^b 6 (G [#])	
G ^b m7 (F [#])		G m7		A ^b m7 (G [#])	
G ^b mM7 (F [#])		G mM7		A ^b mM7 (G [#])	
G ^b m6 (F [#])		G m6		A ^b m6 (G [#])	
G ^b 7 (F [#])		G 7		A ^b 7 (G [#])	
G ^b 7 ⁽⁵⁾ (F [#])		G 7 ⁽⁵⁾		A ^b 7 ⁽⁵⁾ (G [#])	
G ^b 7 ⁽⁵⁾ (F [#])		G 7 ⁽⁵⁾		A ^b 7 ⁽⁵⁾ (G [#])	
G ^b 7sus4 (F [#])		G 7sus4		A ^b 7sus4 (G [#])	
G ^b m7 ⁽⁵⁾ (F [#])		G m7 ⁽⁵⁾		A ^b m7 ⁽⁵⁾ (G [#])	
G ^b dim (F [#])		G dim		A ^b dim (G [#])	
G ^b others (F [#])		G others		A ^b others (G [#])	

Chord Name	Notes	Chord Name	Notes	Chord Name	Notes
A Maj		B ^b Maj (A#)		B Maj	
A sus4		B ^b sus4 (A#)		B sus4	
A aug		B ^b aug (A#)		B aug	
A min		B ^b min (A#)		B min	
A M7		B ^b M7 (A#)		B M7	
A 6		B ^b 6 (A#)		B 6	
A m7		B ^b m7 (A#)		B m7	
A mM7		B ^b mM7 (A#)		B mM7	
A m6		B ^b m6 (A#)		B m6	
A 7		B ^b 7 (A#)		B 7	
A 7 ⁽⁵⁾		B ^b 7 ⁽⁵⁾ (A#)		B 7 ⁽⁵⁾	
A 7 ⁽⁵⁾		B ^b 7 ⁽⁵⁾ (A#)		B 7 ⁽⁵⁾	
A 7sus4		B ^b 7sus4 (A#)		B 7sus4	
A m7 ⁽⁵⁾		B ^b m7 ⁽⁵⁾ (A#)		B m7 ⁽⁵⁾	
A dim		B ^b dim (A#)		B dim	
A others		B ^b others (A#)		B others	

◆ PRESET CHORD PROGRESSION STYLES

The following is a list of Preset Chord Progression styles utilised by the Rhythm Section of the CN43 digital piano.

The Preset Chord Progression styles can last for 8, 12, or 16 bars, with the bar number and chord name written in the spaces below. If a chord name is not written, the previous chord will continued to be played.

The more complicated chord names, such as 'F#m7(b5)', may appear in a simplified form when shown in the LCD screen. If two chords are listed (e.g. 'D/C'), the first letter indicates the key of the chord, while the second letter indicates the key of the bass part.

Display	No. of bars	Chord pattern															
		1 (9)		2 (10)		3 (11)		4 (12)		5 (13)		6 (14)		7 (15)		8 (16)	
Chord1	8	CM7		Bm7(b5)	B-7	Am7		Gm7	C7	FM7		Em7	A7	Dm7		G7sus4	G7
Chord2	12	F#m7(b5) Dm7		B7		Em7		A7		F#m7(b5)		B7		Em7		A7	
Chord3	8	C								F							
Chord4	8	C7						F7		Bb7		G7		C7			
Chord5	8	C7				A-7		Bb7		C7				A-7		G7	
Chord6	16	Cm7 E-M7		D7(#5)		G7sus4		G7sus4 G7		Cm7		F7		B-M7		G7(#5)	
Chord7	12	CM7 Em7	Am7 Am7	Dm7 Em7	G7sus4 Am7	CM7 Dm7	Am7 G7sus4	Dm7 G7sus4		CM7 Am7	Dm7 G7sus4	CM7 Am7	Dm7 G7sus4	CM7 Am7	Dm7 G7sus4		
Chord8	8	CM7		Dm7		CM7		Dm7	G7	Gm7	C7	FM7		Fm7	B-7	CM7	
Chord9	8	C7				Bb7		Dm7		C7				G7		F7	
Chord10	16	C7 C7				E-7 E-7				F7 F7				C7 G7			
Chord11	8	C7				F7		C7		C7				F7			G7
Chord12	8	Cm7				F7				Cm7				F7			
Chord13	8	A-M7		D-M7		Gm7		C7		A-M7		Gm7		F#dim		G7(#5)	
Chord14	8	A-7		G7(#5)		Cm7		F7		A-7		G7(#5)		F7			
Chord15	8	C7								Eb7		F7		C7			
Chord16	16	A-M7 A-M7				Gm7 Gm7				A-M7 A-M7				Gm7 G7sus4		C7sus4 G7	C7
Chord17	8	C		CM7		C7		FM7		FmM7		CM7		F#m7(b5)		G7sus4	G7
Chord18	8	Cm7				Dm7		Gaug		Cm7				Dm7		Gaug	
Chord19	16	A-M7 A-M7		Bb7 Bb7		E-M7 Gm7		A7 C7		A-M7 A-M7		Gaug G7(#5)		Cm7 F7		F7	
Chord20	8	C				D/C				Bb/C				F/C			
Chord21	8	C		G		Bb		F		A-		E-		Dm7		G7	
Chord22	8	CM7		B7(#5)	B7	Bb6		A7		A-M7		Dm7	G7	CM7	Am7	Dm7	G7
Chord23	8	A-/B-		CM7		A-/B-		E-M7		BM7		Bb7		F/A	Dm7(b5)/A-	G7	G7(#5)
Chord24	8	C7						G7									C7
Chord25	8	F7				C7				F7				G7			
Chord26	8	CM7		G7(#5)		Gm7	C7	FM7		Fm7	Bb7	CM7		Am7	D7	G7	
Chord27	8	C7sus4								Bb7sus4							
Chord28	16	CM7 F#m7(b5)		B7		C7 Em7		A7		CM7 F#m7(b5)		B7		C7 Em7			
Chord29	8	Cm CmM7	Cm7	Am7(b5)		A-M7		G7(#5)		Cm CmM7	Cm7	Am7(b5)		A-M7		G7(#5)	
Chord30	16	Fm7 Fm7		Bb7 Bb7		E-M7 E-M7		A-M7 A-M7		Dm7(b5) Dm7(b5)		G7(#5) G7(#5)		Gm7(b5) Cm7		C7	
Chord31	8	C		Dm		G	F	C		A7		Dm		G	F	C	
Chord32	8	C		G7		Am		Am7/G		F		D7		G7			
Chord33	8	C		G7		F				D7		G7		Am			
Chord34	16	C7 G7		F7		G7		F7		C7 C7				F7			
Chord35	8	C		A-M7		Bb		Gm7		C		A-M7		Bb		Gm7	
Chord36	8	A-M7				E-M7				A-M7				E-M7		D7	D-M7
Chord37	16	C Am7		Em7 Em7		Fm7 Am7		C G7				Em7 Em7		Fm7 G7sus4		C G7	
Chord38	8	Em7				Dm7				Em7				Dm7			
Chord39	8	C7								Bb7sus4							
Chord40	8	C7				Bb-m7		Bb7						Bb-m7		Db7	
Chord41	8	C7		Bb/C		A-/B-		Bb		C7		Bb/C		A-/B-		Bb	
Chord42	8	C7				Cm7		Gm7/C		F/C		A-/C		Gsus4/C			
Chord43	8	C7				Eb7		D7						A7			
Chord44	12	FM7 Dm7				Bm7(b5) C6				Em7				E-M7			
Chord45	8	C		Am		F		C	G	C		Am		F		G7	
Chord46	8	Em7		Am7		Dm7		G7		Em7		A7		Dm7		G7	
Chord47	8	FM7		Em7		FM7		Am7		Fm7	Bb7	E-M7	A-M7	Dm7		G7sus4	
Chord48	8	FM7		Em7		FM7		Em7	C7sus4	FM7		Em7	E7	FM7		Dm7	G7sus4
Chord49	8	CM7		FM7		CM7		FM7		Bm7	E7	AM7		GM7		FM7	G7sus4
Chord50	8	A-M7		Gm7		Bb-m7		A-M7	A-7	D-M7		Cm7		Dm7(b5)		G7	
Chord51	8	C		G/B		Gm/Bb		F/A		A-6		C/G		F#m7(b5)		G7	
Chord52	8	F		F#dim		C/G		E7/G#		Am7		D7		Dm7		G7sus4	G7
Chord53	8	CM7		B-M7		CM7		B-M7		Am7		D7		Dm7		G7	G7(#5)
Chord54	8	F#m7(b5)		F7		Em7		A7	A7(#5)	Dm7		G7	G7(#5)	CM7		Gm7	C7
Chord55	8	FM7		FmM7		Em7	E7	Am7		Dm7		G7sus4		CM7			
Chord56	8	CM7		FM7		Bm7(b5)	E7	Am7	C7	FM7		Em7	Am7	Dm7		G7sus4	G7
Chord57	8	C	G/B	F/A	C/G	F	C/E	D7/F#	G7	C	G/B	F/A	C/G	D7/F#	D7	G7sus4	G7
Chord58	8	CM7		FM7		Dm7		G7sus4	G7	FM7	G7	Em7	Am7	Dm7		G7sus4	G7

Display	No. of bars	Chord pattern															
		1 (9)	2 (10)		3 (11)		4 (12)		5 (13)		6 (14)		7 (15)		8 (16)		
Chord59	8	FM7		CM7		FM7		CM7		Em7(-5)	A7	Dm7		Fm7		G7sus4	G7
Chord60	8	C		F		C		F		Am	Dm		G				
Chord61	8	C		F		C		F		G	Am		F	G		C	
Chord62	8	C	Am	Dm	G	C	Am	Dm	G	Em	Am	Dm	G7	Em	Am	Dm	G7
Chord63	8	Cm7	Gm7	Cm7	Gm7	Cm7	Gm7	Cm7	Gm7	Fm7				G7	A-7	G7	
Chord64	8	C		CM7		C7		F		Dm7		Am7		D7		G7	
Chord65	16	Cm7		Fm7		B-7		F7		Cm7		Fm7		F#dim		G7(#5)	
Chord66	8	C				Am				Dm		G		C			
Chord67	16	Am7		D7		G7sus4		C		Am7		D7		G7sus4		C	
Chord68	16	Fm7		E7		Am7		D7		G7sus4		C		G7sus4		C	
Chord69	8	Cm7								B-7sus4							
Chord70	8	Dm7								Dm7							
Chord71	8	C7				E-7sus4								E-7sus4		E-7sus4	
Chord72	8	C7				F7				B-7		G7		C7		F7	
Chord73	12	C				E-7				B-		F		C		G7	
Chord74	8	C		F		C		F						G		F	
Chord75	16	Cm							B-	A-7				Cm		D-7	
Chord76	8	C				F7				C				B-		C	
Chord77	8	C7				C7				G7				C7		F7	
Chord78	16	C				B-7				C7				B-7		F7	
Chord79	8	C		G7		C7		F7		C		F	G7	C	F	C	G7
Chord80	16	Dm7		G7		CM7		Em7		Am7		Dm7		G7		F	
Chord81	16	C		F		C		C	C7	F				C		D7	G7
Chord82	8	C		C7		F		C						G7		C	
Chord83	8	C		C7		F7		C7		F7		Dm7		G7		F7	
Chord84	8	C				E-		D		F				A-		G	
Chord85	8	C7sus4	C7	C7sus4		B-7sus4	B-7	B-7sus4		A-7sus4	A-7	A-7sus4		G7sus4	G7	G7sus4	
Chord86	12	C				G				F				B-		C	G
Chord87	8	C6						C7		F7				C6			
Chord88	16	G7	G	Em7	Am7	Dm7	D7	G7		C	G	Em7	A7	Dm7	G7	C	
Chord89	16	C		CM7	C7	F		Fm6		Em7	A7	Dm7	G7	C	Fm6	C	
Chord90	16	F		CM7	C7	F		Fm6		Em7	A7	Dm7	G7	C	CM7	C7	
Chord91	16	F		Fm6		Em7		Em7		A7		D7sus4		D7		G7sus4	G7
Chord92	12	C		F		C		G		C		F		C	G7	C	
Chord93	12	C		C		C		C						Am			
Chord94	12	C9		F13		C9		F13		F13				G7			
Chord95	12	Dm9		G13		C9	A7(-13)	Dm9	G13					C9		A7(-13)	
Chord96	16	C		CM7		C7		FM7		Dm		DmM7		Dm7		G7	
Chord97	16	C		CM7		Em7(-5)		A7		Dm7		Fm7		Em7	A7	Dm7	G7
Chord98	16	Fm7		B-7		E-M7		E-6		E-M7		A-7		D-M7		D-6	
Chord99	16	C#m7		F#7		Bm7		E7		Am7		D7		Dm7		G7	
Chord100	16	Cm7		Fm7		B-7		E-M7	A7	A-M7		Dm7(-5)		G7	G7(#5)	Cm7	C7
Chord101	8	Fm7		B-7		Gm7		C7	(#5)	Fm7		B-7		E-6		G7	G7(#5)
Chord102	8	Cm7															
Chord103	8	A-M7	D-7	G-M7	C-M7	A-M7	D-7	G-M7		Fm7	B-7	E-M7	A-M7	Fm7	B-7	G7	G7(#5)
Chord104	16	Cm7	Cdim	B-M7		Cm7	Cdim	B-M7		Gm7		C7	C7(#5)	Fm7		Fm7(-5)	
Chord105	16	E-M7	Dm7	D-M7	Cm7	E-M7	Dm7	D-M7	Cm7	G7		G7(#5)		Cm6		Cm7	
Chord106	16	C		D7		Dm7	G7	C		C		D7		Dm7	G7	C	
Chord107	16	C	CM7	C7		F	Fm	C		C	A7	D7		Dm7	G7	C	
Chord108	16	Cm		G7				Cm		G7						Cm	
Chord109	16	Fm		Cm		G7		Cm	C7	Fm		Cm		D7		G7	

◇ SPECIFICATIONS

■ Keyboard	88 keys, Responsive Hammer Action with Ivory Touch and Let-Off
■ Polyphony	Maximum 192
■ Number of Sound	323 + 12 Drum Set
■ Sound Categories	Piano 1, Piano 2, Electric Piano, Drawbar, Church Organ, Harpsi&Mallets, Strings, Choir&Pad, Bass, Others
■ Effects	Reverb (Room1/2, Stage, Hall1/2, Plate), Chorus (1/2/3/4/FB), Flanger, Tremolo, Delay (1/2/3), Rotary (1/2)
■ Temperaments	Equal (Piano Only), Mersenne pure (Major), Mersenne pure (minor), Pythagorea, Meantone, Werckmeister III, Kirnberger III, Equal (flat), Equal
■ Auto Accompaniment	100 rhythms x 2 variations, One Finger Ad-Lib™
■ Other Features	Demo (34 Preset Songs), Concert Magic (88 Preset Songs), Volume, Dual, Split, Four Hands, Balance Slider, Transpose, Tune, Lower Octave Shift, Lower Pedal On/Off, Touch Curve (Light, Light +, Normal, Heavy, Heavy +, Off), MIDI (16 part multi-timbral capability), Damper Hold, Damper Effect, String Resonance, User Memory, Factory Reset
■ Lesson Function	Right/left part balance adjustable, Tempo adjustable. Please refer to the separate 'Concert Magic Song List/Lesson Song List' booklet for a complete listing of available lesson songs.
■ Internal Recorder	2 Tracks, 3 Songs. The total memory capacity of the recorder is approximately 90,000 notes.
■ USB Recorder	SMF format : 16 Tracks, Realtime recording MP3 play : 32 kHz/44.1 kHz/48 kHz, Mono/Stereo, Bitrate: 8-320 kbit/s (fixed & variable) MP3 record : 44.1 kHz, 16 bit, Stereo, 192 kbit/s (fixed) WAV play : 32 kHz/44.1 kHz/48 kHz, Mono/Stereo WAV record : 44.1 kHz, 16 bit, Stereo, 1,411 kbit/s (uncompressed)
■ Metronome	Beat: 1/4, 2/4, 3/4, 4/4, 5/4, 3/8, 6/8, 7/8, 9/8, 12/8
■ Pedals	Sustain, Sostenuto, Soft
■ Jacks	Headphones (2), LINE IN (L/MONO, R), LINE OUT (L/MONO, R), MIDI (IN, OUT), USB (TO HOST, TO DEVICE)
■ Output	Power 50 W x 2
■ Speakers	16 cm x 2, 5 cm x 2
■ Key Cover	Slide type
■ Power Consumption	85 W
■ Dimensions WxDxH (with music rack flattened)	138 cm x 47 cm x 88 cm
■ Weight (without bench)	57.5 kg

◇ MIDI EXCLUSIVE DATA FORMAT

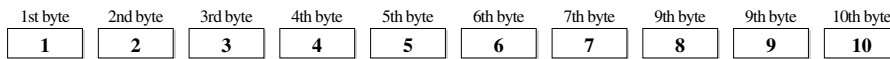

- 1 F0 Start code
- 2 40.....KAWAI's ID number
- 3 00 - 0FMIDI channel
- 4 10, 30.....Function code (30 when setting MULTI TIMBRE ON/OFF)
- 5 04.....Indicates that the instrument is Electronic Piano
- 6 08.....Indicates that the piano is "CN4X"
- 7 data 1
- 8 data 2.....(See the table below.)
- 9 data 3
- 10 F7 End code

data 1	data 2	data 3	Function
00	00	—	Multi Timbre Off
00	01	—	Multi Timbre On 1
00	02	—	Multi Timbre On 2
0D	00-0C	—	00: Effect Off, 01: Chorus 3, 02: Delay 1, 03: Delay 2, 04: Delay 3, 05: Tremolo, 06: Rotary 1, 07: Rotary 2, 08: Chorus 1, 09: Chorus 2 0a: Chorus 4, 0b: EB Chorus, 0c: Flanger
0E	00-03, 06-08	—	00: Reverb Off, 01: Room 2, 02: Stage, 03: Hall 1, 06: Room 1, 07: Hall 2, 08: Plate
14	00-7F	—	Dual/Split balance
16	1F-60	—	Tune, 40: 440 Hz
17	00, 7F	—	00: Program Change Off, 7F: Program Change On
18	00-07	—	00: Light, 01: Normal, 02: Heavy, 03: Off, 04: Light+, 05: Heavy+, 06: User 1, 07: User 2
19	00-03	—	Lower Octave Shift
20	00-7F	00-7F	Dual Program Change, data 2: Right sound, data 3: Left sound
21	00-7F	00-7F	Split Program Change, data 2: Upper sound, data 3: Lower sound
22	00-7F	00-7F	Four Hands, data 2:Right sound, data 3:Left sound
25	00-08	00-0B	data 2: Temperament, data 3: Key
26	00, 7F	00-0F	Multi Timbre, data 2: 00 (On), 7F (Off), data 3: channel
27	00-02	00-02	Dual/Split, Right (Upper)/Left (Lower), sound Bank LSB

◇ MIDI IMPLEMENTATION CHART

KAWAI DIGITATL PIANO
MODEL : CN43Date : September 2010
Version : 1.0

Function		Transmit	Receive	Remarks
Basic channel	Default	1	1 - 16	
	Changes	1 - 16	1 - 16	
Mode	Default	3	3	
	Messages	×	3, 4	
	Altered	*****		
Note number		21 - 108*	0 - 127	* 9 - 120 w/Transpose
	True voice	*****	0 - 127	
Velocity	Note ON	○ 9nH v=1-127	○	
	Note OFF	× 9nH v=0	×	
After touch	Key's	×	×	
	Channel's	×	○	
Pitch bend		×	○	
Control change	0, 32	○	○	Bank Select
	1	×	○	Modulation
	5	×	○	Portament Time
	6, 38	×	○	Data Entry
	7	○	○	Volume
	10	×	○	Panpot
	11	×	○	Expression Pedal
	64	○ (Right pedal)	○	Sustain Pedal
	65	×	○	Portament
	66	○ (Center pedal)	○	Sostenuto Pedal
	67	○ (Left pedal)	○	Soft Pedal
	69	○	○	Hold 2
	70	×	○	Sustain Level
	71	×	○	Resonance
	72	×	○	Release Time
	73	×	○	Attack Time
	74	×	○	Cutoff
	75	×	○	Decay Time
	76	×	○	Vibrato Speed
	77	×	○	Vibrato Depth
	78	×	○	Vibrato Delay
84	×	○	Portament Control	
91	○	○	Reverb Send Level	
93	○	○	Chorus Send Level	
98, 99	×	○	NRPN LSB, MSB	
100, 101	×	○	RPN LSB, MSB	
Program change		○ 0 - 127	○	
	True #	*****		
System exclusive		○	○	
Common	Song Position	×	×	
	Song Select	×	×	
	Tune	×	×	
System Real time	Clock	○	○	
	Commands	○ FA, FB, FC	○	
Aux	All sound Off	×	○ (120)	
	Reset all controller	×	○ (121)	
	Local On / Off	×	×	
	All notes Off	×	○ (123 - 127)	
	Active Sense	○	○	
	Reset	×	×	
Notes				

Mode 1: omni mode On, Poly, Mode 2: omni mode On, Mono
Mode 3: omni mode Off, Poly, Mode 4: omni mode Off, Mono○: Yes
×: No

KAWAI

THE FUTURE OF THE PIANO

CN43 Owner's Manual
KPSZ-0437 : 816960
OW1049E-S1010
Version.3

Printed in Indonesia

Copyright © 2010 KAWAI Musical Instruments Mfg. Co.,Ltd. All Rights Reserved.