

Rodgers 751i/e

751A⁺i/e

751Bi/e

OWNER'S MANUAL

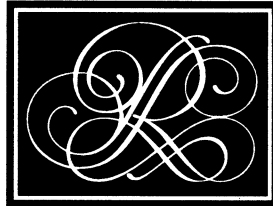

TABLE OF CONTENTS

Table of Contents	i
Introduction	page 1
Features	page 2
Turn On/Turn Off	page 2
Console Division, Combination Memory and Piston Locations	page 2
Console Display and Menus	page 3
Combination Action with Four Memory Levels	page 3
–Unlocking a Combination Memory	page 4
–Setting the Pistons	page 4
–Locking a Combination Memory	page 5
General/Divisional Piston Mode	page 5
–Changing the General to Divisional Piston Mode	page 5
751 User Menu Lists	
–751 User Menu Items	page 6
–751 MIDI Menu Items	page 8
–751 User (Headphone) Menu Items	page 9
Couplers	page 10
Reversibles	page 10
Expression Shoes	page 10
All Swells To Swell	page 10
Tremulants	page 10
–Adjusting the Tremulant Settings	page 11
Tutti	page 11
–Viewing the Tutti Setting	page 11
–Unlocking the Tutti	page 11
–Setting the Tutti	page 11
–Locking the Tutti	page 12
–Restoring the Factory Tutti Setting	page 12
Melody Coupler	page 12
–Setting the Range of the Melody Coupler	page 12
Bass Coupler	page 13
–Setting the Range of the Bass Coupler	page 13
Transposer	page 13
Master Tuning	page 13
–Locking and Unlocking the Master Tuning	page 13
–Adjusting the Pitch	page 14

Temperaments	page 14
–Ancient Temperament: Pythagorean	page 15
–Ancient Temperament: Mean-Tone	page 15
–Well Temperament: Kirnberger	page 15
–Well Temperament: Werckmeister I and III	page 15
–Well Temperament: Young I and II	page 15
–Well Temperament: Equal	page 15
–Selecting a Temperament	page 16
Digital Dynamic Wind™	page 16
Wind Stabilizer	page 16
–Adjusting the Wind Stabilizer	page 17
Random Detuning	page 17
Expression Range Adjustments	page 17
–Setting the Expression Range	page 18
Voice Palette	page 18
–Accessing the Voice Palette	page 19
–Unlocking the Voice Palette	page 19
–Locking the Voice Palette	page 19
Master Volume Control	page 20
–Adjusting the Master Volume	page 20
Audio Save	page 20
–Saving Audio Control Settings	page 20
Stereo Headphone Jack	page 20
–Adjusting the Headphone Settings	page 21
Auxiliary Inputs	page 21
–Adjusting the Auxiliary Inputs	page 20
Stereo Line Outputs	page 21
–Adjusting the Stereo Line Outputs	page 21
Digital Reverberation	page 22
–Setting the Reverb Volume	page 22
–Setting the Reverb Type	page 22
–Setting the Reverb Time	page 22
Antiphonal On/Main Off	page 23
Pipes	page 23
Pipes Off/Ancillary On	page 23
Console Lamp Dimmer	page 23
–Adjusting Console Lamps	page 23
Automatic Shutdown Timer	page 24

MIDI (Musical Instrument Digital Interface)	page 25
–MIDI Channel Assignments	page 25
–Selecting a MIDI Sound	page 25
–Previewing Various MIDI Sounds	page 25
Roland GS Standard Support	page 26
–Setting the GS Variation (Bank Number)	page 26
MIDI Sounds in Combination Pistons	page 27
–Saving a MIDI Sound in a Combination Piston	page 27
Additional MIDI Settings	page 27
MIDI Note Velocity	page 28
–Setting Fixed Velocity	page 28
–Setting Expression Velocity	page 28
–Setting Keyboard Velocity	page 28
Octave Shift	page 29
–Shifting the Octave of a MIDI Sound	page 29
MIDI Channel Assignment	page 29
–Assigning MIDI Channels	page 29
MIDI Save	page 30
–Saving MIDI Control Settings	page 30
Sustain Switch	page 30
Additional MIDI Settings on Combination Pistons	page 30
–Saving MIDI Settings on a Combination Piston	page 30
Enabling/Disabling MIDI Master Channels	page 31
–Enabling or Disabling a MIDI Master Channel	page 31
MIDI Stop Changes	page 32
–Selecting MIDI Stop Change Settings	page 32
–Using Pistons to Control	
a Second Rodgers Console	page 33
MIDI Local Control	page 33
–Enabling or Disabling MIDI Local Control	page 33
MIDI Sequencer Update	page 33
–Enabling or Disabling MIDI Sequencer Update	page 33
MIDI Device ID	page 34
–Setting the MIDI Device ID	page 34
Saving a Combination Memory	page 34
MIDI Connections	page 35
Rodgers 751 Stop Specification	page 36
Console Dimensions	page 37

Factory Default Combination Settings	page 38
–Restoring the Factory Default Combination Settings	page 38
Suggested Registrations	page 39
Great Organ	page 39
Pedal Organ	page 39
Swell Organ	page 40
Blank Chart for Favorite MIDI Sounds (Great)	page 41
Blank Chart for Favorite MIDI Sounds (Swell)	page 42
Blank Chart for Favorite MIDI Sounds (Pedalboard)	page 43
Care and Maintenance	page 44
–Console and Pedalboard	page 44
–Keyboards and Stop Tabs	page 44
–Pipes on Pipe-Augmented Instruments	page 44
Safety Instructions	page 45
Radio and Television Interference Notice (FCC Notice)	page 47
MIDI Implementation Chart	page 48

INTRODUCTION

Grand, glorious sound is the hallmark of the Rodgers 751. Providing a rich and spacious ensemble sound complemented by crystal-clear definition, the Rodgers 751 will take you to new musical heights, while sustaining the tradition of quality, craftsmanship and innovation you've come to expect from Rodgers.

Parallel Digital Imaging (PDI™), Rodgers' proprietary software-based technology that revolutionized the digital organ world, permits each note of every stop of the Rodgers 751 to be individually tuned, leveled and voiced after installation, just like an organ with wind-blown pipes.

With remarkable flexibility, superior sound and the option of adding real pipes at any time, the Rodgers 751 is a perfect choice for any home, concert or worship setting.

Built entirely in Oregon by dedicated, expert craftsmen, our consoles are meticulously hand-crafted of hardwoods and veneers, and are designed to the exacting standards of the American Guild of Organists.

This manual will help with the exploration of the expansive capabilities and the variety of features and functions offered by this instrument. As highly sophisticated as the Rodgers 751 is, the features are easy to use and easy to access, creating a most satisfying musical experience for the player and listener alike.

The Rodgers 751 is a wonderful example of Rodgers' commitment to celebrate tradition while creating the future. From the first notes that sound forth from the Rodgers 751 to the endless possibilities of sound combinations developed over the years to come, we think you will agree Rodgers is indeed *the sound choice!*

Rodgers Simply Sounds Better!

FEATURES

To get started, here is a tour of the basic operations of the Rodgers 751:

TURN ON/TURN OFF

To turn the organ on, press the top part of the rocker switch in the left panel. “RODGERS 751 CLASSIC ORGAN” or your personalized greeting will appear in the Console Display. The organ will perform a self diagnostic test of its systems within a few seconds. When completed, the Console Display will read “TRANSPOSER 0”. The Rodgers 751 is ready to play. To turn the power off, press the lower part of the rocker switch.

CONSOLE DIVISION, COMBINATION MEMORY AND PISTON LOCATIONS

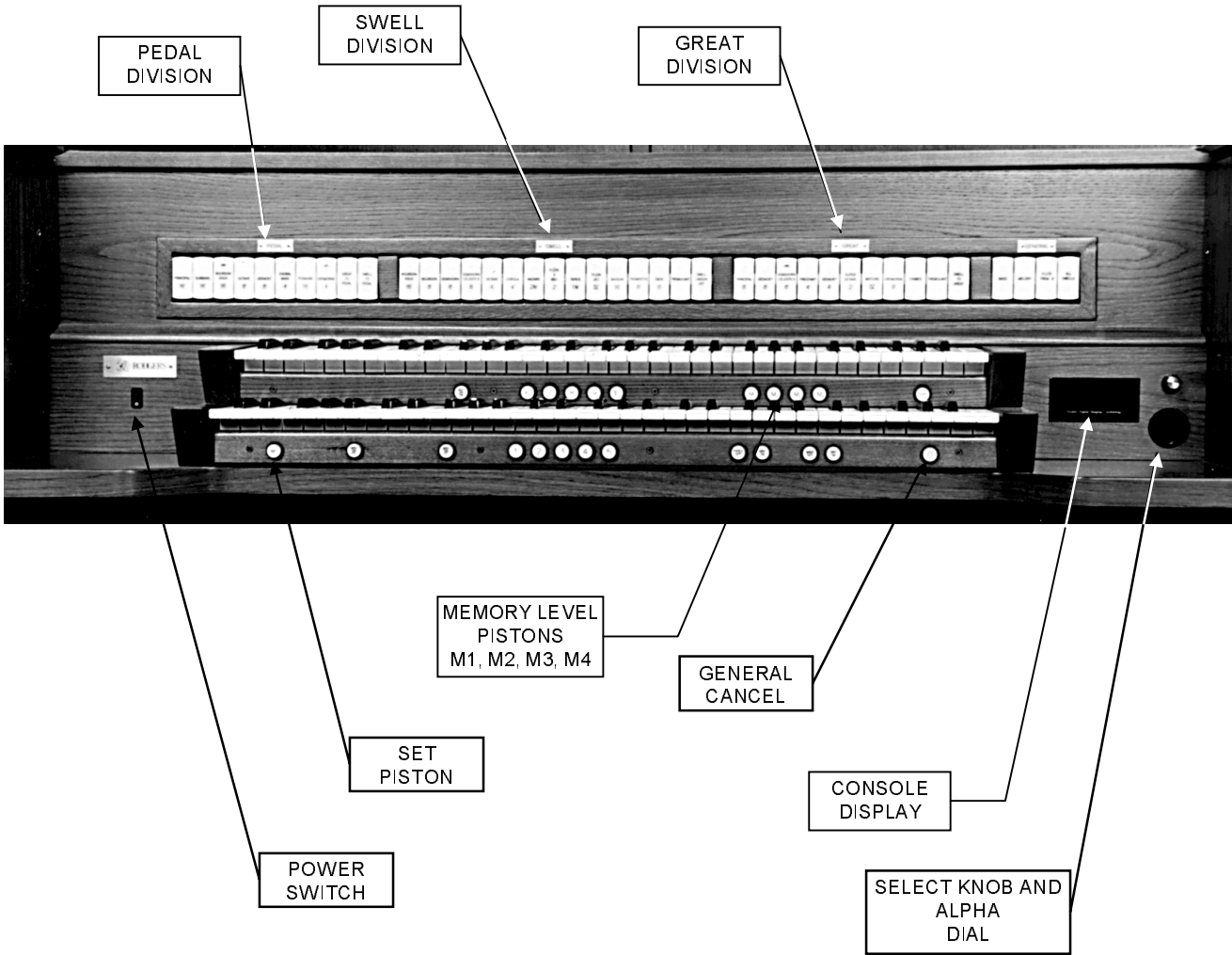

CONSOLE DISPLAY AND MENUS

The Rodgers 751 is equipped with a two-line Console Display window located on the right below the stop rail panel. This display indicates the Transposer setting, and it can be used to alter many other settings and organist preferences including MIDI settings, and Tremulant rate and depth, among many others.

Two controls are used to select and operate the features of the Console Display. The *smaller knob*, located near the Console Display, is called the *Select Knob* and is used to select different menu items to be changed. When the Console Display reads “TRANSPOSER 0”, this knob controls the Transposer function. The *larger flush dial*, near the Console Display, is called the *Alpha Dial* and is used to change a menu setting which has been selected.

To move to a new menu or to make a new setting in the same menu in the Console Display, hold SET and turn the Select Knob. *Note: Once any menu other than the Transposer menu has been selected, it is no longer necessary to hold SET to select further menus.*

The *blinking square* in the Console Display, called the *cursor*, indicates the setting which is currently selected. Rotating the Alpha Dial will change the value of any selected setting.

There are three different menus. The User Menu accesses organ and audio settings such as Tremulant settings, Master Volume, and Auxiliary Input controls. This menu is accessed by holding SET and turning the Select Knob counter clockwise (left) from the Transposer menu.

The second menu controls MIDI settings and is accessed by holding SET and turning the Select Knob clockwise (right) from the Transposer menu.

The third menu also accesses organ and audio settings, but it is only available when headphones are used. *Note: Please refer to the “Stereo Headphone Jack” section.*

To return to the Transposer display, press General Cancel.

COMBINATION ACTION WITH FOUR MEMORY LEVELS

The Rodgers 751 features a combination action easily changed by the organist from the console. The organist can pre-select registrations and make rapid changes in tone color using this advanced system.

Rodgers’ microprocessor combination action is a specially refined four-memory system. This effectively multiplies the number of physical pistons on the console by four.

The 10 General pistons simultaneously affect all stops and controls on the Great, Swell and Pedal. All manual and pedal registrations may be changed by pressing a General piston.

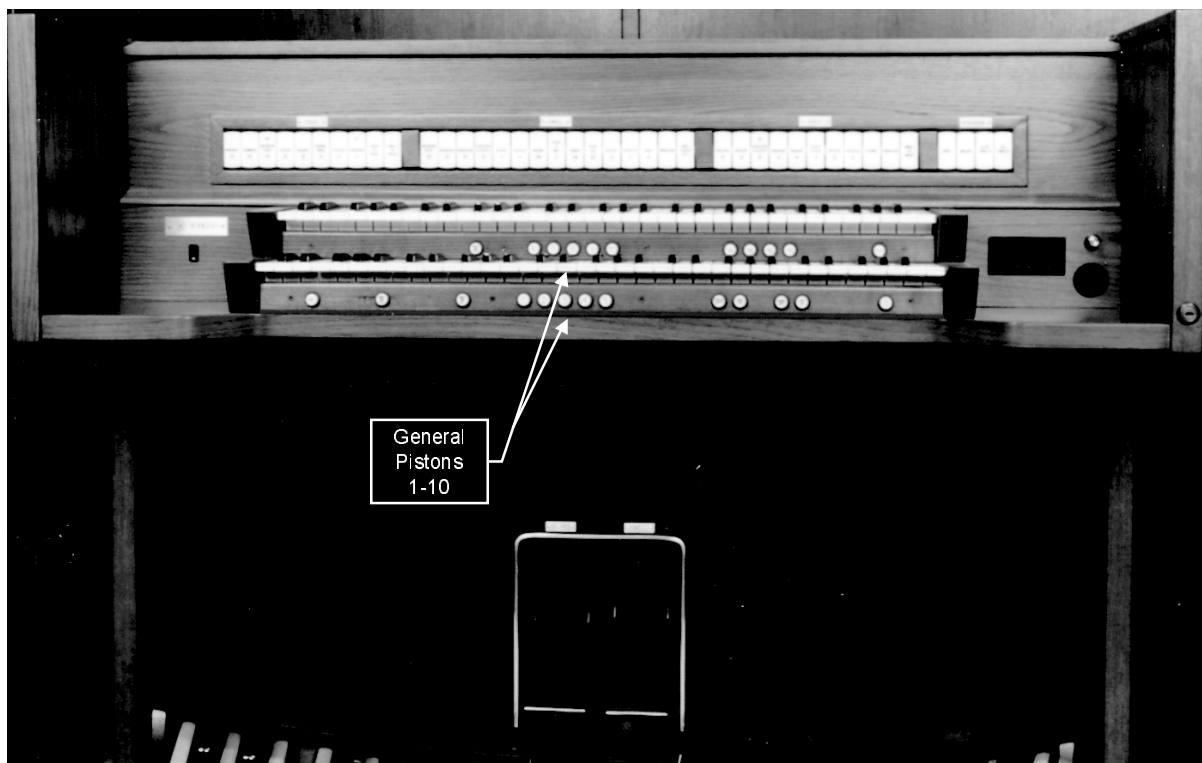

A combination memory must be unlocked to set pistons. Once the pistons are set, the combination memory may be locked again to prevent accidental change.

◆ **UNLOCKING A COMBINATION MEMORY:**

1. Press and hold M1, M2, M3 or M4 located under the Swell manual to the right for approximately five seconds. “USING INTERNAL MEMORY” appears in the Console Display first. Then “MEMORY (#) LOCKED” appears.
2. While continuing to hold the memory piston, rotate the Alpha Dial either direction until the Console Display reads “MEMORY (#) UNLOCKED.”
3. Release the memory piston. The memory is now unlocked.

◆ **SETTING THE PISTONS:**

1. Select a memory by pressing M1, M2, M3 or M4. *Note: Pistons cannot be set if the memory is locked. Please refer to the “Unlocking a Combination Memory” section.*
2. Select the desired stops.
3. Press and hold the SET piston, located under the Great manual to the far left.
4. While holding SET, press the desired combination piston. Then release both pistons.

Note: Stops may be added or deleted from any combination using the above procedure.

◆ **LOCKING A COMBINATION MEMORY:**

1. Press and hold M1, M2, M3 or M4 for approximately five seconds. “USING INTERNAL MEMORY” appears in the Console Display first. Then “MEMORY (#) UNLOCKED” appears.
2. While continuing to hold the memory piston, rotate the Alpha Dial either direction until the Console Display reads “MEMORY (#) LOCKED.”
3. Release the memory piston. The memory is now locked.

GENERAL/DIVISIONAL PISTON MODE:

This feature allows the ten General pistons to become five Great and five Swell Divisional pistons. In the default “GEN” mode, the ten pistons act as General pistons. In the “DIV” mode, the five pistons located under the Great manual become Great/Pedal Divisional pistons, controlling stops in both the Great and Pedal Divisions. Also, the five pistons located under the Swell manual become Swell (only) Divisional pistons.

Note: This feature is not available on all versions.

◆ **CHANGING THE GENERAL TO DIVISIONAL PISTON MODE:**

1. Press and hold the SET piston.
2. Turn the Select Knob counter clockwise (left) until the Console Display reads:



3. Rotate the Adjust dial to change the setting to GEN or DIV. The setting will be remembered when the organ is turned off. (The default setting is GEN.)
4. Press General Cancel to return to the Transposer menu.

751 User Menu Items

Hold SET, turn SELECT knob counterclockwise.

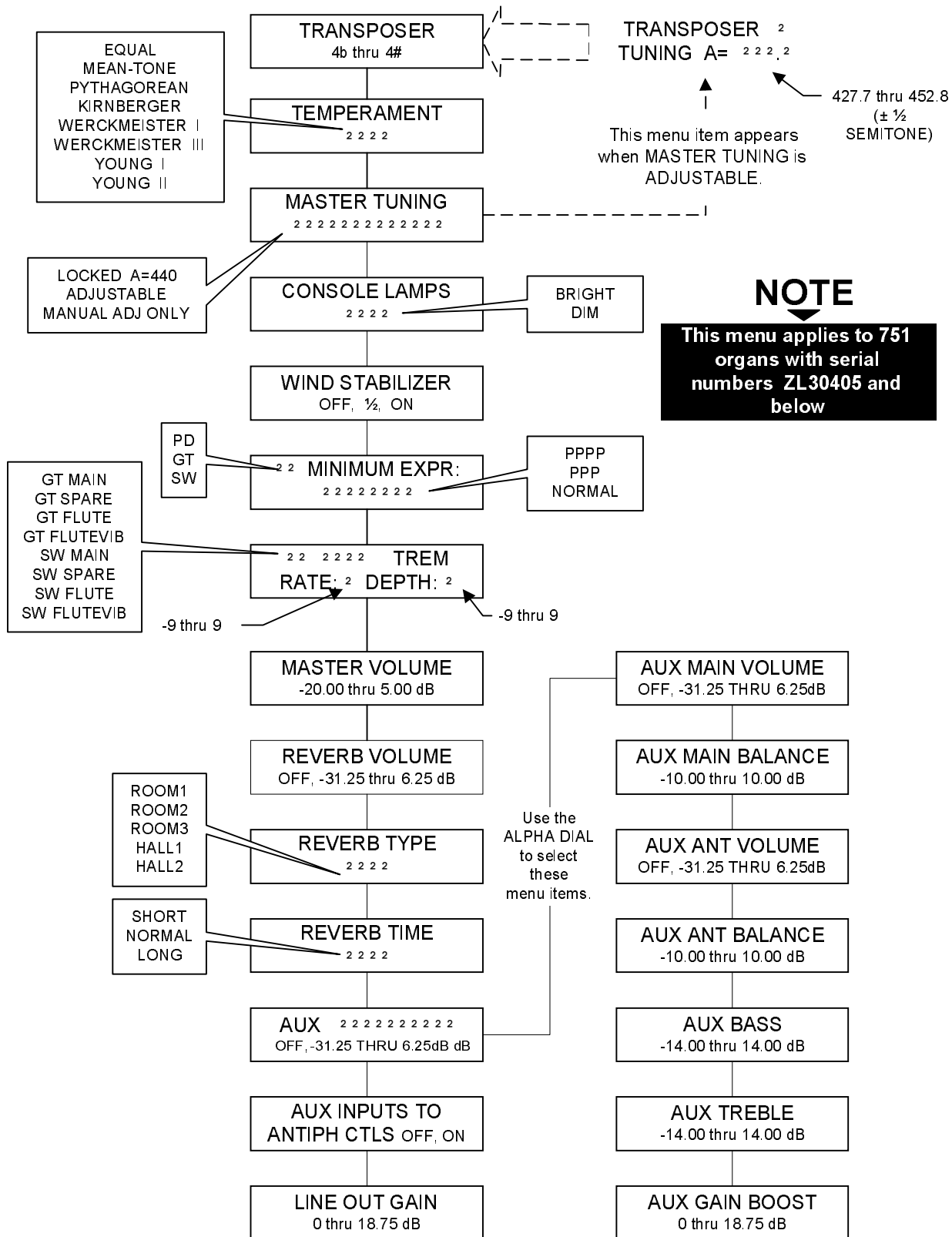
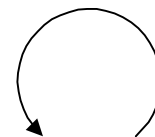

751 User Menu Items

Hold SET, turn SELECT knob
counterclockwise.

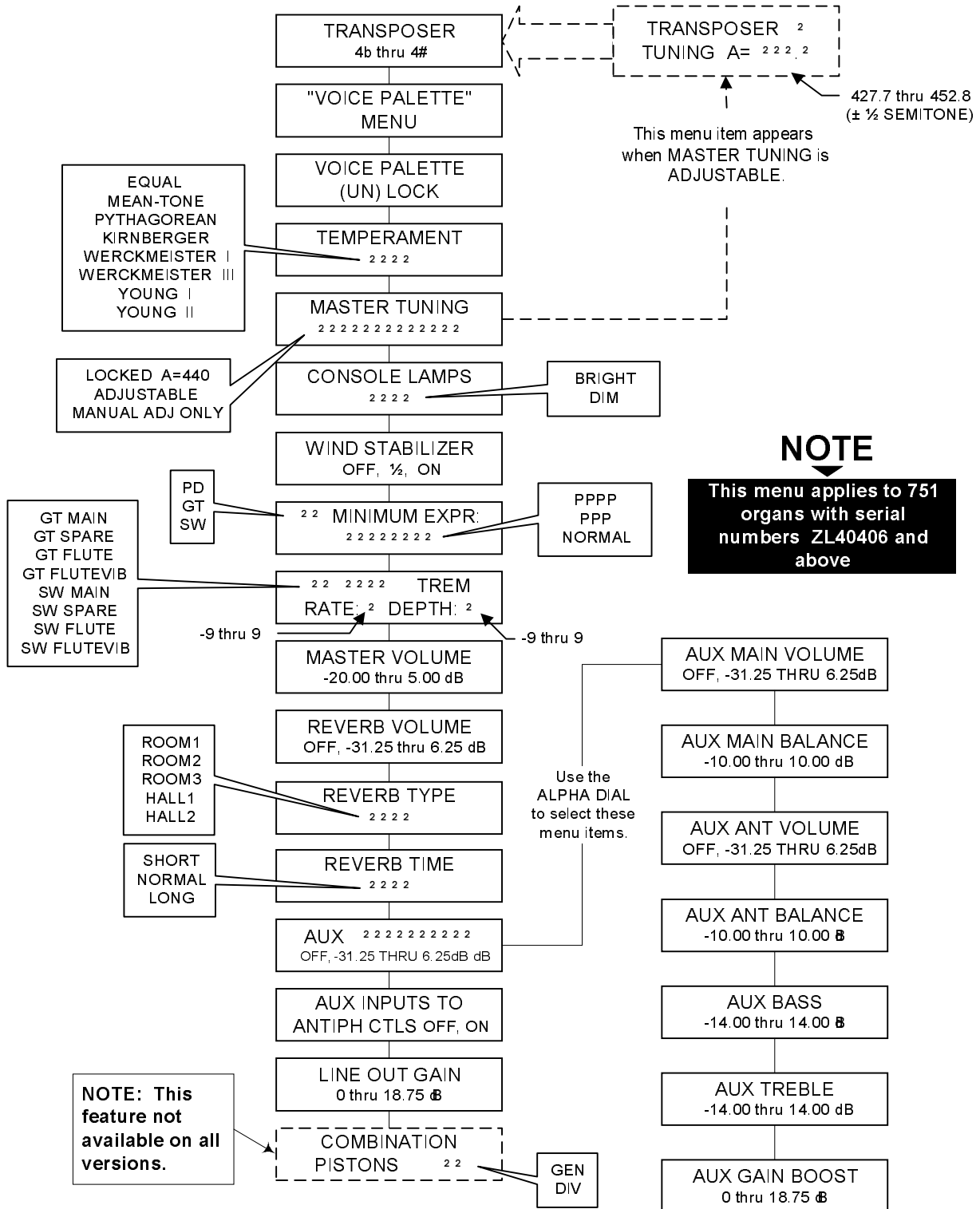
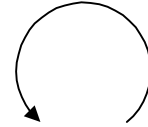

751 MIDI Menu Items

Hold SET, turn SELECT knob clockwise.

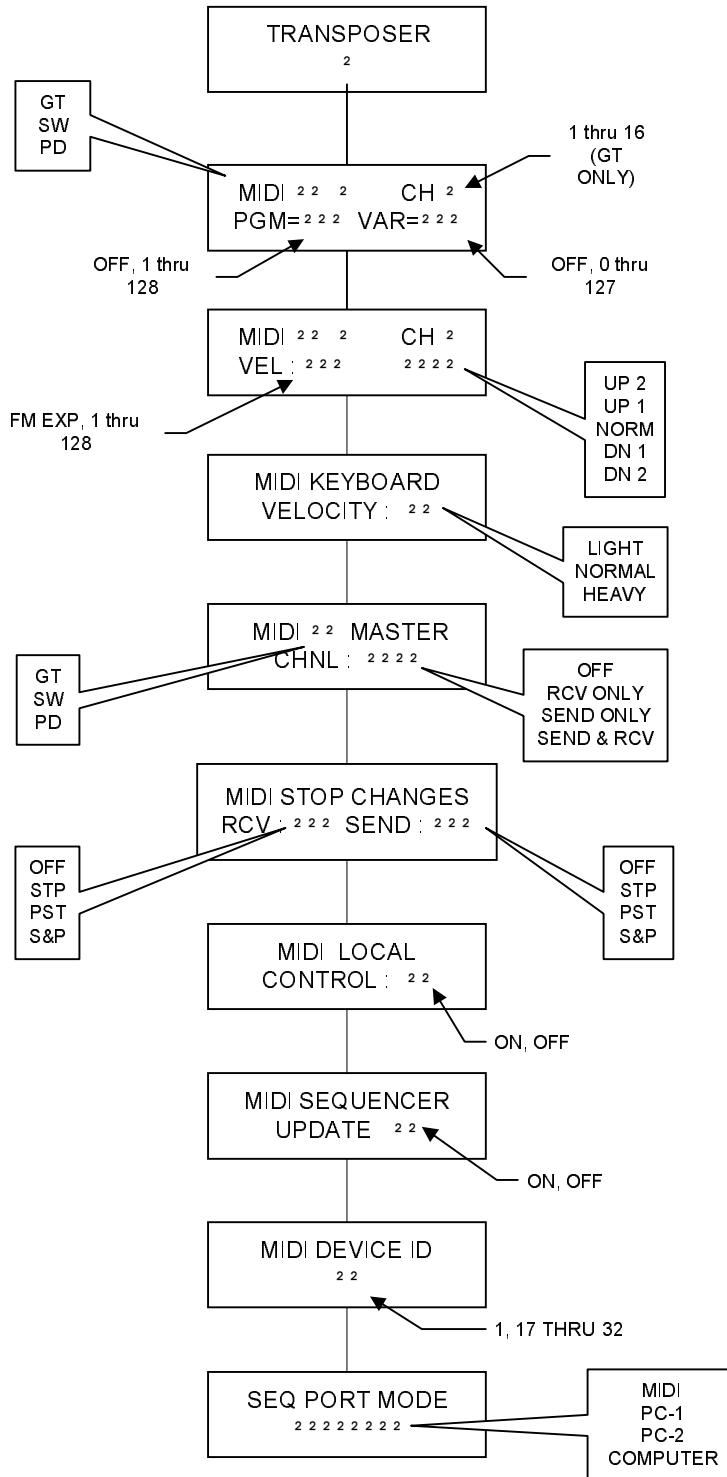
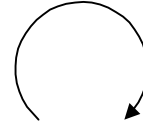

751 Headphone User Menu

Hold SET, turn SELECT knob counterclockwise.

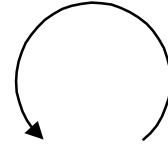

NOTE
Headphones must be plugged in for these menu items to appear. See previous menu (USER MENU) for items not related to the use of headphones

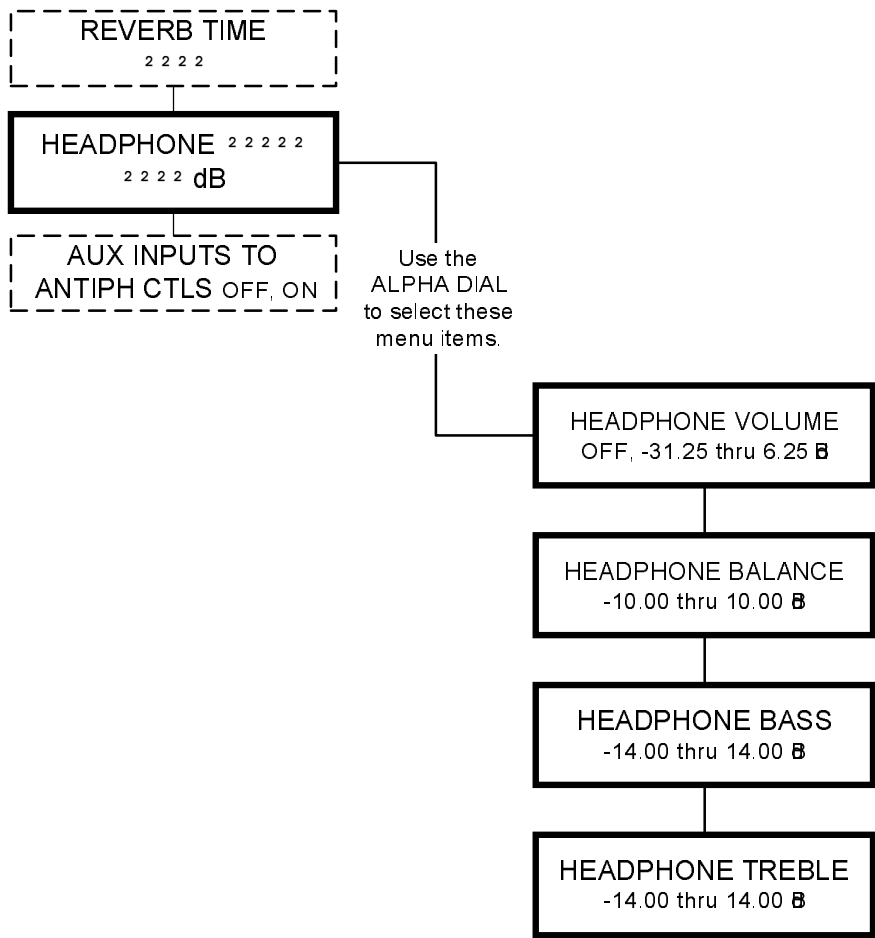

COUPLERS

The Rodgers 751 has intermanual couplers, which enable stops of one division to be played on another keyboard or the pedalboard. The couplers are SWELL TO GREAT 8', SWELL TO PEDAL 8' and GREAT TO PEDAL 8'. These couplers are located on the lighted tabs in the Great and Pedal divisions.

REVERSIBLES

The Rodgers 751 is equipped with reversible pistons. These control certain couplers and functions. Press the piston to turn on, and press again to turn off. All reversible pistons light when engaged.

EXPRESSION SHOES

The Rodgers 751 has two expression shoes. The *left* expression shoe controls the voices in the Great and Pedal divisions, and the *right* expression shoe controls the voices in the Swell division.

ALL SWELLS TO SWELL

For ease of expression control using only one shoe, press the ALL SWELLS tab located on the stop rail to the right in the General section. When it is lit, the Great, Swell and Pedal divisions are expressed with the Swell expression shoe. It may be stored in combination pistons.

TREMULANTS

Tremulants create a change in pitch (sharp and flat), amplitude (volume) and timbre (tone quality). The use of the tremulant adds warmth to solo or small ensemble combinations. It is not common to use tremulants in larger classical ensembles. In some romantic ensembles, tremulants are used judiciously. In some gospel and evangelical musical traditions, tremulants with a wider and deeper excursion are frequently used.

There are two types of tremulant controls on the Rodgers 751. The *Divisional* tremulants (Great and Swell) affect only the stops in the respective division. There is one *General* tremulant, the FLT TREM II tremulant, which affects all manual flute stops simultaneously.

All tremulants may be individually adjusted for rate and depth by performing the following procedure:

◆ **ADJUSTING THE TREMULANT SETTINGS:**

1. Press and hold the SET piston.
2. Turn the Select Knob counter clockwise (left) until the Console Display reads:



3. Turn the Select Knob until the cursor is on the tremulant name. *Note: Please refer to the “751 User Menu Items” section.*
4. Rotate the Alpha Dial until the Console Display reads the tremulant to be adjusted.
5. Turn the Select Knob until the cursor is on the rate.
6. Rotate the Alpha Dial until the Console Display reads the desired tremulant rate.

Note: The range is from -9 to +9. The rate setting may be previewed by selecting a corresponding stop and playing a note while the adjustment is made.

TUTTI

There are times when a full organ registration is needed immediately. The Tutti on the Rodgers 751 can be set with any combination of stops. Press the TUTTI piston to access the Tutti combination. This piston is reversible, so simply press again to cancel.

◆ **VIEWING THE TUTTI SETTING:**

1. Press and hold the TUTTI piston.
2. While holding the TUTTI piston, press the SET piston. The stops of the Tutti setting light.

Note: Tutti cannot be set unless it is unlocked.

◆ **UNLOCKING THE TUTTI:**

1. Press and hold the TUTTI piston for approximately five seconds until “TUTTI LOCKED” appears in the Console Display.
2. While continuing to hold TUTTI, rotate the Alpha Dial either direction until the Console Display reads “TUTTI UNLOCKED.”
3. Release the TUTTI piston. The Tutti is unlocked.

◆ **SETTING THE TUTTI:**

1. Select the desired stops.
2. Press and hold the SET piston, and press the TUTTI piston. The Tutti is set.

◆ **LOCKING THE TUTTI:**

1. Press and hold the TUTTI piston for approximately five seconds until “TUTTI UNLOCKED” appears in the Console Display.
2. While continuing to hold TUTTI, rotate the Alpha Dial either direction until the Console Display reads “TUTTI LOCKED.”
3. Release TUTTI. The Tutti is locked.

◆ **RESTORING THE FACTORY TUTTI SETTING:**

1. Press and hold the TUTTI piston for approximately five seconds. The Console Display reads “TUTTI LOCKED” or “TUTTI UNLOCKED”.
2. While holding TUTTI, press and hold SET for an additional five seconds. The Console Display reads “TUTTI FACTORY DEFAULT”.
3. Release both pistons.

MELODY COUPLER

The Melody Coupler (MELODY) is located on the back rail to the right. The Melody Coupler lights when it is engaged.

When MELODY is lit, any selected stop or MIDI voice in the Swell division sounds from the highest key being played on the Great manual. This allows a solo melody and an accompaniment to be played on the same manual.

In its default setting, the Melody Coupler affects keys 21 (25 on some versions) through 61 on the Great manual. The lower end of its range is programmable and may be extended down to key 13 or up to key 49.

Note: The Melody Coupler can only be set in General combination pistons.

◆ **SETTING THE RANGE OF THE MELODY COUPLER:**

1. Press and hold the SET piston, and press MELODY which begins flashing.
2. Release the piston and tab.
3. While the Melody Coupler is flashing, press a key which corresponds to the lowest note the range is to extend. Any note from key 13 to key 49 may be selected. After the selected key has been pressed, the Melody Coupler turns off. *Note: When a key is pressed to set the range, no sound is heard even if stops are on, so no disturbance is made if programming during a performance.*
4. To use the new range, press MELODY. This range is saved when the organ is turned off.

BASS COUPLER

The name of this feature is derived from the historical term “Basso Continuo” meaning thoroughbass. When the Bass Coupler is engaged, it will light. Any selected stops or couplers in the Pedal division will sound from the lowest key being played on the Great manual. This provides a pedal bass sound without actually playing the pedalboard. The Bass Coupler (BASS) is located on the stop rail to the right in the General section.

In the default setting, the Bass Coupler affects keys 1 through 24 of the Great manual, but its range is programmable up to key 32 (top of the pedalboard range).

◆ SETTING THE RANGE OF THE BASS COUPLER:

1. Press and hold the SET piston, and press BASS which begins flashing.
2. Release both controls.
3. While BASS is flashing, press a key which corresponds to the highest note the range is to extend. Any note from key 1 to key 32 may be selected. After the selected key has been pressed, BASS turns off. *Note: When a key is pressed to set the range, no sound is heard even if stops are on, so no disturbance is made if programming during a performance.*
4. To use the new range, press BASS. This range is saved when the organ is turned off.

Note: The Bass Coupler can only be set in General combination pistons.

TRANSPOSER

The Transposer is the default menu setting in the Console Display. Turning the Select Knob while “TRANSPOSER 0” is displayed lowers the pitch of the organ up to four semitones (half steps) and raises the pitch up to four semitones. The Transposer returns to “0” when General Cancel is pressed. *Note: In order to select menu items other than the Transposer, it is necessary to first hold SET, and then turn the Select Knob.*

MASTER TUNING

The Rodgers 751 can easily and quickly be tuned to a piano or musical instrument not at standard concert pitch (A=440.0). The range of the Master Tuning is one-half semitone sharp or flat.

If the instrument has been augmented with pipes, the Master Tuning feature is used to bring the electronics in tune with the pipes. The pitch will return to A=440.0 when the organ is turned off. Adjustments to the tuning cannot be made unless the Master Tuning is unlocked.

◆ LOCKING AND UNLOCKING THE MASTER TUNING:

1. Press and hold the SET piston.
2. Turn the Select Knob counter clockwise (left) until the Console Display reads:

MASTER TUNING
LOCKED A = 440.0

3. Rotate the Alpha Dial until the Console Display reads “ADJUSTABLE” or “MANUAL ADJ ONLY”.
4. Press General Cancel to return to the Transposer menu. *Note: The Console Display reads “TRANSPOSER 0 TUNING A=440.0” (default setting) when the Master Tuning is unlocked.*

◆ **ADJUSTING THE PITCH:**

1. Make sure the Master Tuning is unlocked.
2. The Console Display reads:

TRANSPOSER 0
TUNING A = 440.0

3. Rotate the Alpha Dial to adjust the tuning.

Note: When the organ is turned off, the tuning will return to the default setting (A=440.0).

TEMPERAMENTS

In recent years, there has been a renewed interest in authentic interpretation of organ literature written before the adoption of Equal Temperament tuning. Until the middle of the 18th century, the relative pitches of the notes of the scale were chosen to favor music written in key signatures with few sharps or flats; more remote keys produced varying degrees of aural distress. Many composers of the day utilized moderately out of tune intervals to evoke momentary tension to the listener. With the adoption of the Equal Temperament (“Well-Tempered”) tuning system, almost universal today, all keys became equally out of tune, and the intentions of these earlier composers were lost, to some degree.

The Rodgers 751 offers a choice of eight temperaments: Equal, Mean-Tone, Kirnberger, Werckmeister I, Werckmeister III, Young I, Young II and Pythagorean. This selection of temperaments allows the organist to hear these historical works as their composers heard them, or to explore the application of unequal temperament to new music.

Ancient Temperaments

Pythagorean: Pythagoras (582-500 BC) was a brilliant Greek theorist and mathematician. The Pythagorean temperament is characterized by pure fifths and fourths. The Pythagorean theory founded a diatonic scale which served as a model throughout the Middle Ages.

Mean-Tone: Mean-Tone temperament improves on the Pythagorean tuning by slightly contracting each of the four fifths needed to generate a major third. Major thirds and in-tune fifths are slightly narrow, and the differences between the major and minor seconds are smoothed out. Many artists now prefer Mean-Tone temperaments when performing 15th through 17th century repertoire.

J.S. Bach's Well Tempered Clavier, written in 1722 and 1738-42, is a collection of 24 paired preludes and fugues written in every major and minor key. The title refers to the use of a temperament in which all keys are satisfactorily in tune, but not necessarily an absolutely equal temperament.

Well Temperaments

Kirnberger: Johann Philipp Kirnberger (1721-1783) was a German composer and pupil of Bach from 1739-41. His temperament favored pure fifths, as in the Pythagorean model, but performance was improved in many keys.

Werckmeister I and III: Andreas Werckmeister experimented with temperaments in the latter part of the 17th century. In Werckmeister I he further refined the Mean-Tone temperament. In Werckmeister III, four tones are practically tuned identical to Equal Temperament (C, D#, F# and A).

Young I and II: Young Temperaments offer further refinements to the Mean-Tone model, except with slightly higher pitched sharps.

Equal: Equal Temperament is the modern standard which utilizes a succession of 12 semitones of equal size, allowing performance in all keys successfully. The fifths are slightly narrowed and the upward thirds are considerably sharp, but unlimited modulation from key to key is possible ♦ selecting a temperament:

1. Press and hold the SET piston.
2. Turn the Select Knob counter clockwise (left) until the Console Display reads:

TEMPERAMENT EQUAL

3. Release SET.
4. Rotate the Alpha Dial until the desired temperament appears.
5. Press General Cancel to return to the Transposer menu.

Note: When the organ is turned off, the temperament will return to Equal.

DIGITAL DYNAMIC WIND™

Part of the personality of an individual pipe organ relates to the steadiness of the wind supply to the pipes. Because air is an elastic medium, there is some amount of “give” in the wind supply of every pipe instrument. Some organs exhibit more unsteadiness than others, according to the type of wind regulators used (single or multiple reservoirs, schwimmer regulators, etc.). A small amount of unsteadiness in the wind helps the listener to identify the sound as that of a wind-blown instrument, although too much can be distracting. Certain types of music, though, seem to gain charm from a less-than-perfect wind system.

Another characteristic of pipe organs involves changes in pitch which occur in individual pipes when playing large numbers of pipes together. These pitch changes are due both to variations in wind pressure as the wind demand becomes greater and to the influence of the sound from neighboring pipes. This latter effect is greatest upon large-scale flute voices and least upon narrow-scaled string voices. Even though this results in significant detuning, the human ear seems to perceive instead an increase in ensemble effect.

Rodgers’ exclusive patented Digital Dynamic Wind emulates these characteristics by modeling the behavior of pipe organ wind regulating devices and the response of pipes to a slightly unsteady wind supply. Some independent ranks have their own “software reservoir,” and each voice is programmed to respond to wind variations in the same way its equivalent pipe rank or ranks would respond.

WIND STABILIZER

In order to adjust the behavior of the organ wind system, a “WIND STABILIZER” menu is provided in the Console Display. This stabilizer operates in much the same way as does the stabilizer control provided on some pipe instruments. In the “OFF” position, the wind has a noticeable unsteadiness in the playing of rapid passages or large chords. The “1/2” position reduces this unsteadiness somewhat, and the “ON” position makes the wind steady under all conditions. The position is saved when the organ is turned off.

◆ ADJUSTING THE WIND STABILIZER:

1. Press and hold the SET piston.
2. Turn the Select Knob counter clockwise (left) to “WIND STABILIZER”.
3. Release SET.
4. Rotate the Alpha Dial to select “OFF”, “1/2”, or “ON”.

RANDOM DETUNING

One of the essential ingredients of a pipe organ ensemble arises from the small amount of pitch error in each pipe. No matter how carefully an instrument is tuned, small changes in temperature or humidity causes the pipes to drift from their original pitches. Reed pipes are especially prone to drift over time due to “creeping” of the tuning wire with cyclic temperature variations.

The Random Detuning feature causes selected notes to receive a small amount of detuning. The amount of detuning is chosen at random for each note of each voice. Some notes will not be detuned at all. The number of notes detuned and the maximum amount of detuning are selected for each voice to mimic the behavior of an equivalent pipe set. For instance, reeds will exhibit more pitch error than flues. Because the detuning is random, there is no degradation of the overall temperament of the instrument and the amount of detuning is no more than one would experience in a recently-tuned pipe instrument.

This detuning process happens each time the organ is turned on. Once computed, the pitch of each note remains constant. Thus, the tuning will be a little different, as it would be with a pipe organ, each time the organ is used. The amount of Random Detuning present in the organ will be set by a Rodgers representative during final voicing.

EXPRESSION RANGE ADJUSTMENTS

The minimum volume of each division when its Expression Shoe is closed can be adjusted to suit specific musical needs or personal tastes. The “MINIMUM EXPR:” menu allows three settings—“NORMAL”, “*ppp*”, and “*pppp*”. The “NORMAL” setting produces the amount of expression obtained on most pipe instruments with typical swell shades. The “*ppp*” setting produces a greater range than the “NORMAL” setting, and the “*pppp*” setting produces the amount of expression one might expect from very heavy and thick swell shades. The settings do not affect the sound at all when the expression shoe is open.

There are special settings of the Expression Range that can be selected when installing a pipe/electronic combination organ. When speakers for the enclosed division (Swell) are placed inside a pipe organ swell box, the digitally sampled electronic stops in those divisions can sound at a constant volume by setting the Expression Range to “Unenclosed”. Then the expression of those stops, like the pipes in the swell box, will be controlled by the swell shades.

◆ SETTING THE EXPRESSION RANGE:

1. Press and hold the SET piston.
2. Turn the Select Knob counter clockwise (left) to “MINIMUM EXPR:”, and place the cursor over the division name.
3. Rotate the Alpha Dial to select the desired division.
4. Turn the Select Knob clockwise (right). The cursor moves to the bottom line.

5. Rotate the Alpha Dial to select the desired expression range. If the expression shoe is closed and notes are played on voices in the division being adjusted, the change is heard immediately. All expression range settings are saved when the organ is turned off.

VOICE PALETTE™

Some of the speaking stops on the Rodgers 751 can play additional voices which are selectable through the Voice Palette™ menu. These voices are:

<u>DIVISION</u>	<u>TILT TAB</u>	<u>VOICE PALETTE</u>
PEDAL:	16' Posaune	16' Basson
GREAT:	8' Principal	8' Diapason
	8' Flûte Celeste II	8' Erzähler Celeste II
	8' Cromorne	8' Trompete
	Chimes	Harpsichord
SWELL:	16' Basson	16' Fagot

Note: The drawknobs with small dots above the stop name denote where a palette voice is located.

The voices located on one stop control cannot be played simultaneously. However, a stop's primary voice may be stored on one combination piston, and its Voice Palette selection may be stored on another combination piston.

◆ ACCESSING THE VOICE PALETTE:

1. Press and hold the SET piston.
2. Turn on the stop to be changed. For example, select the 16' Posaune in the Pedal. The Console Display reads:

PD POSAUNE 16 =
POSAUNE 16

3. Rotate the Alpha Dial to view the available Voice Palette selection. The voice may be previewed as it is selected.

The voice selections made using this procedure can be saved in General and Divisional combination pistons. All drawknobs return to their default voices as labeled when the organ is turned off.

In order to save Voice Palette selections in combination pistons, the Voice Palette must first be unlocked. This locking feature only prevents “blind” changes to Voice Palette selections; manual changes are always possible.

◆ UNLOCKING THE VOICE PALETTE:

1. Press and hold the SET piston.
2. Turn the Select Knob counter clockwise (left). The Console Display reads:



3. Rotate the Alpha Dial to unlock the Voice Palette. Voice Palette selections can now be stored in combination pistons.

When the Voice Palette is locked, combination pistons will not affect Voice Palette selections, even selections previously saved in combination pistons.

◆ LOCKING THE VOICE PALETTE:

1. Press and hold the SET piston.
2. Turn the Select Knob counter clockwise (left). The Console Display reads:

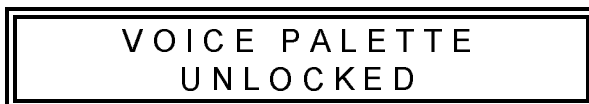

3. Rotate the Alpha Dial to lock the Voice Palette. MASTER VOLUME CONTROL

Special situations and individual preferences sometimes require a temporary change in the overall volume of the organ. This is easily accomplished.

◆ ADJUSTING THE MASTER VOLUME:

1. Press and hold the SET piston.
2. Turn the Select Knob to “MASTER VOLUME”.
3. Rotate the Alpha Dial to obtain the desired volume level. *Note: An Audio Save may be performed to save this setting as the default. Please refer to the “Audio Save” section.*

AUDIO SAVE

Changes made to audio settings are temporary and are lost when the organ is turned off unless those settings are saved. This can be done by performing the following procedure.

◆ SAVING AUDIO CONTROL SETTINGS:

1. While in any Audio Menu, hold SET, then press and hold General Cancel for approximately five seconds.
2. Continue holding both pistons until the Console Display reads:

AUDIO CONTROL SETTINGS SAVED

3. Release SET and General Cancel.

Any changes made to any audio control settings are saved when the organ is turned off.

STEREO HEADPHONE JACK

The console is equipped with a 1/4" stereo headphone jack located on the Connector Panel under the keydesk to the right. Plugging a set of headphones into this jack disables the sound from all speakers, and disables any pipe ranks connected to the instrument. When using headphones, the "MASTER VOLUME" menu is replaced with the "HEADPHONE" menu. This menu allows the adjustment of Volume, Balance, Bass, and Treble heard through the headphones. These adjustments do not affect the organ speakers in normal playing mode. *Note: Please refer to the "751 User (Headphone) Menu Items" section.*

◆ ADJUSTING THE HEADPHONE SETTINGS:

1. Press and hold SET.
2. Rotate the Select Knob counter clockwise (left) until the Console Display reads "HEADPHONE", and place the cursor on the top line.
3. Release SET.
4. Rotate the Alpha Dial to select the setting to be adjusted ("VOLUME", "BALANCE", "BASS", or "TREBLE").
5. Turn the Select Knob clockwise (right) to place the cursor on the bottom line.
6. Rotate the Alpha Dial to set the desired value.

AUXILIARY INPUTS

The Rodgers 751 is equipped with stereo Auxiliary Input Jacks (one for the left channel and one for the right channel) located on the Connector Panel under the keydesk to the right. When using these input jacks, audio signals from other sound generating devices like synthesizers, MIDI

sound modules, and tape players are mixed into the organ's main audio system. A series of Console Display menu controls is used to adjust the characteristics of the Auxiliary Input sound.

◆ ADJUSTING THE AUXILIARY INPUTS:

1. Press and hold the SET piston.
2. Turn the Select Knob counter clockwise (left) to "AUX", and place the cursor on the top line.
3. Release SET.
4. Rotate the Alpha Dial to select the desired control.
5. Turn the Select Knob clockwise (right) to place the cursor on the bottom line.
6. Rotate the Alpha Dial to obtain the desired effect. *Note: An Audio Save may be performed to save this setting as the default. Please refer to the "Audio Save" section.*

STEREO LINE OUTPUTS

The Rodgers 751 is equipped with stereo Line Outputs also located on the Connector Panel. When using these outputs the divisions of the organ (Great, Swell and Pedal) are heard in stereo. There is no specific channel assignment (left or right) given to these divisions. The volume may be adjusted by performing the following procedure:

◆ ADJUSTING THE STEREO LINE OUTPUTS:

1. Press and hold the SET piston.
2. Turn the Select Knob counter clockwise (left) to "LINE OUT GAIN".
3. Release SET.
4. Rotate the Alpha Dial to adjust the volume .

Note: An Audio Save may be performed to save this setting as the default. Please refer to the "Audio Save" section.

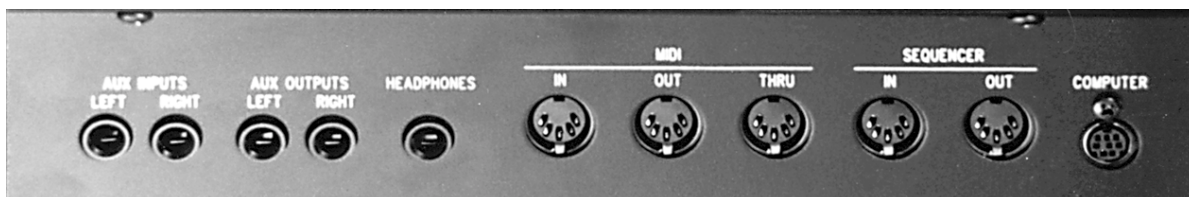

DIGITAL REVERBERATION

The Rodgers 751 features an internal digital reverberation system. The volume, length and type of reverberated sound can be individually changed. Any changes made to the reverberation settings from this menu are temporary and are lost when the organ is turned off, unless they are

saved by performing the Audio Save procedure. *Note: An Audio Save may be performed to save this setting as the default. Please refer to the “Audio Save” section.*

◆ **SETTING THE REVERB VOLUME:**

1. Press and hold the SET piston.
2. Turn the Select Knob counter clockwise (left) until the Console Display reads “REVERB VOLUME”. Release SET.
3. Rotate the Alpha Dial to set the desired reverb level (OFF, -31.25 through 6.25 dB). *Note: An Audio Save may be performed to save this setting as the default. Please refer to the “Audio Save” section.*

◆ **SETTING THE REVERB TYPE:**

1. Press and hold the SET piston.
2. Turn the Select Knob counter clockwise (left) until the Console Display reads “REVERB TYPE”. Release SET.
3. Rotate the Alpha Dial to set the desired reverb type (“ROOM 1”, “ROOM 2”, “ROOM 3”, “HALL 1” or “HALL 2”). *Note: An Audio Save may be performed to save this setting as the default. Please refer to the “Audio Save” section.*

◆ **SETTING THE REVERB TIME:**

1. Press and hold the SET piston.
2. Turn the Select Knob counter clockwise (left) until the Console Display reads “REVERB TIME”. Release SET.
3. Rotate the Alpha Dial to set the desired reverb time (“SHORT”, “NORMAL” or “LONG”). *Note: An Audio Save may be performed to save this setting as the default. Please refer to the “Audio Save” section.*

ANTIPHONAL ON/MAIN OFF

The 751 is prepared with ANTIPHONAL ON (ANT ON)/MAIN OFF lighted pistons which can operate an additional speaker system. An antiphonal speaker system is usually installed at the opposite end of the building from the main organ allowing greater musical flexibility. The ANTIPHONAL ON piston activates this additional speaker system, and the MAIN OFF piston turns off the main organ. *Note: If the MAIN OFF piston is engaged, the ANTIPHONAL ON piston must be engaged or the organ will not sound through either system. (It is possible for the installer to change the function of these pistons.)*

PIPES

Any digital sampled rank in the Rodgers 751 may be replaced by a real wind-blown pipe rank. Partial pipe ranks may be extended to full compass using Rodgers’ exclusive voicing software

with an existing sampled voice. Preparations for controlling real expression shutters are already included in the organ software. *Note: Please refer to the “Expression Range” section.*

Contact your authorized Rodgers representative for additional information.

PIPES OFF/ANCILLARY ON

If the Rodgers 751 is equipped with pipe ranks, certain stops will control pipe voices and other stops will control digitally sampled voices. There are two pistons affecting the pipe stops of all divisions simultaneously (ANC ON and PIPES OFF).

When the ANC ON piston is engaged, electronic voices play from the pipe stops. When the PIPES OFF piston is engaged, the real wind blown pipes turn off. *Note: If the PIPES OFF piston is engaged, the ANC ON piston must also be engaged for the stop(s) to sound.*

CONSOLE LAMP DIMMER

The illumination of the music rack, lighted stop tabs, and pedal lamps is adjusted by performing the following procedure:

◆ ADJUSTING THE CONSOLE LAMPS:

1. Press and hold the SET piston.
2. Turn the Select Knob counter clockwise (left) until the Console Display reads:



CONSOLE LAMPS
BRIGHT

3. Release SET.
4. Rotate the Alpha Dial to the desired intensity. The intensity choices are bright or dim.

Note: When the organ is turned off, this setting is saved

AUTOMATIC SHUTDOWN TIMER

When the organ is on and left unattended, the power automatically turns off after two hours. Operating any key, stop, or control resets the timer for another two hours.

Playing the organ from a remote MIDI keyboard or sequencer will also reset the timer. *(Some 751i/e models may not have this feature.)*

MIDI (Musical Instrument Digital Interface)

Rodgers organs have some of the most advanced MIDI capabilities in the world, offering a great variety of sound possibilities. These sounds are accessed by the MIDI coupler pistons located on the piston rails. A MIDI sound can be played simultaneously from each of the Great, Swell and Pedal divisions.

The MIDI coupler pistons control the following MIDI channels:

Great Manual	Channel 1*	MIDI GT
Swell Manual	Channel 2	MIDI SW
Pedal Manual	Channel 3	MIDI PED

* May be changed to any of the sixteen MIDI channels.

◆ SELECTING A MIDI SOUND:

Selecting a MIDI sound is also known as Sending a Program Change:

1. Press and hold the SET piston, then press a MIDI coupler piston. The MIDI coupler piston flashes, indicating a sound selection can be made. This is called the MIDI Set Mode. The Console Display reads:

MIDI GT	CH 1
PGM = 1 2 1	VAR = 0

2. Select the desired sound (Program Change) number from the sound module instrument chart(s) provided with the sound module. Press a key on the Great, Swell or Pedal. *Note: Program Changes 1-61 are sent by the Great keys, Program Changes 62-122 by the Swell keys, and Program Changes 123-128 by the Pedal notes. Once the key is pressed, the Console Display returns to "TRANSPOSER 0".*

◆ PREVIEWING VARIOUS MIDI SOUNDS:

A variety of MIDI sounds may be previewed before making a selection. To listen to various MIDI sounds:

1. Press and hold the SET piston, then press a MIDI coupler piston. The MIDI coupler piston flashes. Continue to hold SET.
2. By continuing to hold SET, the organ will remain in the MIDI Set Mode.
3. Press the key corresponding to the Program Change number of the desired MIDI sound. *Note: Please refer to the sound module instrument chart(s) provided with the sound module.*

4. Release SET to play the sound being previewed.
5. To preview another MIDI sound, hold SET and press another key to select another Program Change number.
6. Press the MIDI coupler piston or General Cancel to exit the MIDI Set Mode.

When in the MIDI Set Mode, selecting a different Program Change number may also be done by turning the Select Knob until the cursor in the Console Display is over the Program Change number. Rotate the Alpha Dial until the desired number is selected. Press the MIDI coupler piston.

For advanced MIDI applications there are times when no Program Change is to be sent by a MIDI coupler piston. Then the Program Change number may be set to “OFF” by pressing a key which has no associated Program Change number (a high Pedal note, for example), or by turning the Alpha Dial past Program #128 until “PGM OFF” appears in the Console Display.

ROLAND GS STANDARD SUPPORT

In the past, most MIDI sound modules provided a maximum of 128 sounds. These were selected by using MIDI Program Change messages, but they did not define standard sound assignments for those messages. For example, one sound module may have had a trumpet on Program Change #39, yet another sound module would have chimes on #39. It was difficult at best for musicians to work with no standardization of sounds. With the creation of General MIDI (GM), a standard list of sounds was defined, but only for the 128 sounds in the first bank, Bank 0.

The Roland GS Standard honors that same standard list of sounds for Bank 0, but also allows access to *more* than those 128 sounds. By selecting another bank using the Bank Select message, the GS Standard provides an additional 127 banks (also called *variations*), each containing 128 sounds. This allows for the possibility of up to 16,384 total sounds. Many manufacturers of MIDI sound modules have added or will soon add support for this standard, which is an upward extension of the current General MIDI Standard.

The MIDI menu on the Console Display enables the organist to choose a GS Bank Select message for each MIDI coupler piston which is saved on combination pistons.

◆ SETTING THE GS VARIATION (BANK NUMBER):

1. Press and hold SET, then press a MIDI coupler piston. The piston flashes, indicating the MIDI Set Mode is active. The Console Display reads:

M I D I G T	C H 1
P G M = 1 2 1	V A R = 0

2. Turn the Select Knob clockwise (right). The cursor moves to the Variation Field (“VAR”) in the menu. *Note: The variation numbers for sounds in the MIDI sound module are listed in the sound module instrument chart(s) provided with the sound module.*

3. To choose the desired Variation (bank) number, rotate the Alpha Dial until the correct variation number is displayed. Variation 0 is the normal General MIDI bank. OFF may also be selected to prevent a MIDI coupler piston from sending Bank Select messages.
4. Select a Program Change number, or return to the Transposer menu by pressing the MIDI coupler piston or General Cancel.

The variation selected is saved in combination pistons along with the other MIDI settings.

MIDI SOUNDS IN COMBINATION PISTONS

Once a MIDI sound has been set on a MIDI coupler piston, the same Program Change number is sent each time the coupler piston is activated. The sound is also saved on any combination piston that includes that MIDI coupler piston.

Each MIDI coupler piston has a number of associated settings which may be changed in the Console Display. These settings along with the MIDI sound can be saved in a combination piston. Each combination piston may include one or more MIDI coupler pistons. The MIDI coupler piston settings can be saved at any time using the MIDI Save procedure. The saved settings are retained when the organ is turned off.

◆ SAVING A MIDI SOUND IN A COMBINATION PISTON:

After selecting a MIDI sound on a MIDI coupler piston, this can be saved on a General or Divisional combination piston for immediate recall.

1. Select a MIDI sound on a MIDI coupler piston.
2. Press and hold the SET piston, then press the combination piston where the MIDI sound is to be saved.
3. Release both pistons.

ADDITIONAL MIDI SETTINGS

There are many MIDI settings that can be saved. If the settings are changed and not saved, the original MIDI settings (*default* settings) return when the organ is turned off. MIDI settings that can be changed and saved include MIDI note velocity, octave shift, and MIDI transmit and receive parameters.

Changes made to MIDI settings are temporary and are lost when the organ is turned off unless those settings are saved. *Note: A MIDI Save may be performed to save a MIDI setting as the default. Please refer to the "MIDI Save" section.*

MIDI NOTE VELOCITY

MIDI note velocity controls the attack quality and loudness of MIDI sounds. To sound authentic, instruments such as the piano and other percussion instruments require a greater and

more pronounced attack than instruments such as the flute or oboe. The velocity can be individually selected on each MIDI coupler piston, and these settings can then be saved on combination pistons. The three types of MIDI note velocity on the Rodgers 751 are Fixed Velocity, Expression Velocity, and Keyboard Velocity.

Fixed Velocity: The same velocity value is used for all notes of the keyboard or pedalboard, and can be set to any value from 2 to 127.

◆ **SETTING FIXED VELOCITY:**

1. Hold the SET piston, then press the MIDI coupler piston. The piston flashes. Release both pistons.
2. Turn the Select Knob clockwise (right) until the cursor moves to the second menu screen and is positioned in the Velocity field (“VEL”).
3. Rotate the Alpha Dial to select the desired velocity value (2-127).
4. Press either the flashing MIDI coupler piston or General Cancel to exit. *Note: A MIDI Save may be performed to save this setting as the default. Please refer to the “MIDI Save” section.*

Expression Velocity: This velocity is controlled by the expression shoes and is not affected by the attack of the keys. The volume (MIDI Main Volume, Control Change #7) is set to maximum when this setting is in use.

◆ **SETTING EXPRESSION VELOCITY:**

1. Hold the SET piston, then press the MIDI coupler piston. The piston flashes. Release both pistons.
2. Turn the Select Knob clockwise (right) until the cursor moves to the second menu screen and is positioned in the Velocity field (“VEL”).
3. Rotate the Alpha Dial to select Expression Velocity (“FM EXP”).
4. Press either the flashing MIDI coupler piston or General Cancel to exit. *Note: A MIDI Save may be performed to save this setting as the default. Please refer to the “MIDI Save” section.*

Keyboard Velocity: This setting individually senses the velocity of each note of the keyboard. There are three sensitivity levels that can be selected.

◆ **SETTING KEYBOARD VELOCITY:**

1. Hold the SET piston, then press the MIDI coupler piston. The piston flashes. Release both pistons.
2. Turn the Select Knob clockwise (right) until the cursor moves to the second menu screen and is positioned in the Velocity field (“VEL”).
3. Rotate the Alpha Dial to select Keyboard Velocity (“FM KBD”).

4. Turn the Select Knob clockwise (right) until the cursor moves to the fourth menu screen and is positioned in the Keyboard Velocity field (“KEY VEL”).
5. Rotate the Alpha Dial to select the desired velocity value (“LIGHT”, “NORMAL” or “HEAVY”).
6. Press either the flashing MIDI coupler piston or General Cancel to exit. *Note: A MIDI Save may be performed to save this setting as the default. Please refer to the “MIDI Save” section.*

The MIDI Note Velocity can be individually set for each MIDI coupler piston. *Note: The MIDI Note Velocity settings do not affect the sampled organ voices.*

OCTAVE SHIFT

Normally all MIDI coupler pistons play at standard pitch (middle C = note 60). The Octave Shift setting can be set to cause any sound on a MIDI coupler piston to play one or two octaves above or below standard pitch.

◆ SHIFTING THE OCTAVE OF A MIDI SOUND:

1. Hold the SET piston, and press the MIDI coupler piston.
2. Turn the Select Knob clockwise (right) until the cursor moves to “NORM” on the second MIDI menu screen.
3. Rotate the Alpha Dial to the desired setting (“UP 2”, “UP 1”, “NORM”, “DN 1” or “DN 2”).
4. Press either the flashing MIDI coupler piston or General Cancel to exit. *Note: A MIDI Save may be performed to save this setting as the default. Please refer to the “MIDI Save” section.*

MIDI CHANNEL ASSIGNMENT

Using the Rodgers 751 as a MIDI keyboard controller for sequencing may require channel assignment of the MIDI GT coupler piston. All other MIDI coupler pistons transmit on fixed channels. To reset the transmit channel of MIDI GT, perform the following procedure.

◆ ASSIGNING MIDI CHANNELS:

1. Hold the SET piston, then press MIDI GT. The coupler piston flashes.
2. Turn the Select Knob clockwise (right) until the cursor moves to the channel number.
3. Rotate the Alpha Dial to set the channel number.
4. Press either the flashing MIDI coupler piston or General Cancel to exit.

The channel number for MIDI GT coupler piston can be saved in the settings on a combination piston or saved permanently by performing the MIDI Save procedure. *Note: A*

MIDI Save may be performed to save this setting as the default. Please refer to the “MIDI Save” section.

MIDI SAVE

Changes made to MIDI settings are temporary and will be lost when the organ is turned off unless those settings are saved. This is done by performing the following procedure.

◆ SAVING MIDI CONTROL SETTINGS:

1. While in any MIDI menu, make the desired changes.
2. To save, press and hold the SET piston, then press and hold General Cancel for approximately five seconds.
2. Continue holding both pistons until the Console Display reads:

ALL MIDI SETTINGS SAVED

3. Release both pistons.

SUSTAIN SWITCH

A foot switch is located on the top left edge of the Great/Pedal expression shoe. This switch will sustain MIDI sounds playing from MIDI GT coupler piston. Press the switch to sustain, release to stop.

ADDITIONAL MIDI SETTINGS ON COMBINATION PISTONS

After additional MIDI settings have been selected on a MIDI coupler piston, these settings can be saved on any General or corresponding Divisional combination piston.

◆ SAVING MIDI SETTINGS ON A COMBINATION PISTON:

1. Select the MIDI coupler piston (and organ stops, if desired).
2. Press and hold the SET piston.
3. Press the desired combination piston.
4. Release both pistons.

The factory default settings for the MIDI coupler pistons are:

MIDI GT	=	CH 1*
Program Change (PGM)	=	OFF
Variation (VAR)	=	0
Octave Transpose	=	NORM
Velocity (VEL)	=	64

* This channel will be different for each MIDI coupler piston. *Note: Please refer to the MIDI channel list at the beginning of the MIDI section.*

Remember, MIDI default settings can be changed by performing a MIDI Save procedure.

ENABLING/DISABLING MIDI MASTER CHANNELS

The Rodgers 751 reserves several MIDI channels for recording and playback of the organ using a MIDI sequencer. One channel is reserved for each division as follows:

Great Master Channel	Notes and Expression	12
Swell Master Channel	Notes and Expression	13
Pedal Master Channel	Notes and Expression	14

The organ sends and receives MIDI information on these channels unless they are disabled. It may be necessary to disable one or more Master Channels when using the organ console as a MIDI keyboard controller in multi-track or multi-layer sequencing, to avoid duplicating note data on multiple tracks.

◆ ENABLING OR DISABLING A MIDI MASTER CHANNEL:

1. Press and hold the SET piston, and turn the Select Knob clockwise (right) to “MIDI MASTER CHANNEL”.
2. Place the cursor on the division name field (“GT”, “SW”, or “PED”).
3. Rotate the Alpha Dial until the desired selection is displayed.
4. Turn the Select Knob clockwise (right) to move the cursor to the channel status field (“OFF”, “RCV ONLY”, “SEND ONLY”, “SEND & RCV”).
5. Rotate the Alpha Dial to set the Master Channel status for this selection. *Note: Turning a manual’s Master Channel off prevents the organ from sending or receiving notes or expression on that channel.*
6. Press General Cancel to exit.

MIDI STOP CHANGES

When sequencing or controlling another Rodgers console from the Rodgers 751, stop selections are normally transmitted and received using MIDI System Exclusive messages. This allows the stops selected during sequencing to play back accurately.

If desired, the organ stops may be controlled using MIDI Program Changes rather than System Exclusive messages. These Program Changes will control the organ pistons rather than the individual stops. The System Exclusive method normally offers the optimum control over registration, since it does not require the organ pistons to be set up beforehand. The use of piston Program Changes for stop control is most useful when controlling a Rodgers organ from a remote MIDI keyboard or when controlling a second Rodgers console other than a Rodgers 751 via MIDI.

The MIDI Stop Change menu item allows the organist to control the transmission and reception of System Exclusive (SysEx) Stop Control messages and Piston Program Change messages. Settings in this menu are saved when the organ is turned off.

Note: Piston Program Change messages are transmitted and received on the organ Master Channels and should not be confused with the Program Change messages used to select sounds from MIDI coupler pistons.

◆ SELECTING MIDI STOP CHANGE SETTINGS:

1. Press and hold the SET piston, then turn the Select Knob clockwise (right) to “MIDI STOP CHANGE”.
2. Turn the Select Knob to choose “RCV” or “SEND”.
3. Rotate the Alpha Dial to select the following options.

The Receive Field (“RCV”) has four positions:

“OFF”	Console ignores both SysEx and Program Changes
“STP”	Console receives only SysEx messages
“PST”	Console receives only Piston Program Changes
“S&P”	Console receives both SysEx and Program Changes

The Send Field (“SEND”) has the same four positions:

“OFF”	Console does not send either SysEx or Program Changes
“STP”	Console sends only SysEx messages
“PST”	Console sends only Piston Program Changes
“S&P”	Console sends both SysEx and Program Changes

Program Changes 1-10 on any Master Channel will activate the organ General Pistons of like number. Program Change 20 on any Master Channel will activate the organ’s General Cancel piston. Program Changes 21-25 on any Master Channel will activate the organ Divisional Pistons for the division corresponding to that Master Channel.

◆ USING PISTONS TO CONTROL A SECOND RODGERS CONSOLE:

1. Connect the MIDI Sequencer Output of the master console to the Sequencer Input of the slave console.
2. On the master console, enable piston transmission by turning the Select Knob until the cursor is in the Send Field (“SEND”) of the MIDI Stop Change menu.
3. Rotate the Alpha Dial until the Console Display reads “SEND: PST”.
4. On the slave console, enable piston reception by turning the Select Knob until the cursor is in the Receive Field (“RCV”) of the MIDI Stop Change menu.
5. Rotate the Alpha Dial until the Console Display reads “RCV: PST”.

MIDI LOCAL CONTROL

When in the “OFF” position, MIDI Local Control allows the organ console to play MIDI sounds only, disabling the organ voices. When in the “ON” position, the organ will function normally. In the OFF position, organ voices can still be played by a sequencer or by a remote keyboard connected to the 751 MIDI IN jack.

◆ ENABLING OR DISABLING MIDI LOCAL CONTROL:

1. Press and hold the SET piston, then turn the Select Knob clockwise (right) to “MIDI LOCAL CONTROL”.
2. Release SET.
3. Rotate the Alpha Dial to choose “ON” or “OFF”. This selection is temporary. The organ will always return to MIDI “LOCAL CONTROL ON” when the organ is turned off.
4. Press General Cancel to exit.

MIDI SEQUENCER UPDATE

MIDI Start, Stop and Continue messages generated by a sequencer are accepted by the organ only when the MIDI Sequencer Update is enabled.

◆ ENABLING OR DISABLING MIDI SEQUENCER UPDATE:

1. Press and hold the SET piston, then turn the Select Knob clockwise (right) to “MIDI SEQUENCER UPDATE”.
2. Release SET.
3. Rotate the Alpha Dial to choose “ON” or “OFF”. This selection is temporary. The organ will always return to MIDI “SEQUENCER UPDATE ON” when the organ is turned off.
4. Press General Cancel to exit.

Note: The organ uses the sequencer control messages to automatically record the stop and expression status at the beginning of a sequence.

MIDI DEVICE ID

Device ID allows the organist to select the MIDI Device identification number used in System Exclusive Stop Control messages. Normally, the organ both sends and recognizes an ID number of 17. Stop Control messages with other ID numbers will be ignored.

This ID number can be changed to allow independent control over multiple organ consoles connected via MIDI or to facilitate storing multiple sets of registration information on a sequencer recording. The number can be set to 1, or 17 through 32. Setting the ID to 1 produces Stop Control messages which are compatible with older Rodgers PDI and C-Series organs. The ID always returns to 17 when the organ is turned off.

◆ SETTING THE MIDI DEVICE ID:

1. Press and hold the SET piston, then turn the Select Knob clockwise (right) to “MIDI DEVICE ID”.
2. Rotate the Alpha Dial to set the desired ID number.
3. Press General Cancel to exit.

SAVING A COMBINATION MEMORY

The contents of any combination memory may be saved into a MIDI sequencer and later reloaded into the organ.

1. Connect the Sequencer MIDI IN to the organ Sequencer MIDI OUT. Connect the Sequencer MIDI OUT to the organ Sequencer MIDI IN.
2. Start the sequencer in Record mode.
3. Wait until after any count-in measures, then hold the SET piston and momentarily press the memory piston (M1, M2, M3 or M4) for the memory to be copied to the sequencer.
4. Release SET and wait until the Console Display reads:



MEMORY COPIED TO
SEQUENCER PORT

5. Stop the MIDI Sequencer, or wait a few seconds and repeat steps 3 and 4 above to send another memory to the sequencer. Always leave a few measures of space between memories.

To reload a memory from the sequencer, first connect the sequencer following the steps above. Then continue:

1. Play back the recorded memory as a song would be played back.

2. When the memory contents have been correctly received, the memory piston corresponding to the memory on the sequencer recording flashes. At this point, the contents of the memory are stored in a temporary holding area in the console.
3. Stop the sequencer playback.
4. Press and hold SET, then press the memory piston for the desired destination. *Note: This need not be the same memory as the memory whose tab is flashing.*

When copying more than one memory to the sequencer, it is necessary to wait a few measures between saving individual memories, or place them on different tracks. This procedure will reduce confusion regarding the location of the memories on the sequencer.

When playing back the memories, play only one at a time. Each time the organ starts to receive a new memory, it discards any previous information in the temporary holding area. It is necessary to transfer each memory to its destination memory in the organ before playing back the next.

MIDI CONNECTIONS

Always connect a sequencer to the Sequencer IN/OUT ports on the organ. **The sequencer must not be in “Soft Thru” mode.** Any other MIDI instruments or keyboards should use the ports labeled “MIDI.”

RODGERS 751

STOP SPECIFICATION

[alternate Voice Palette™ stop names listed in ()]

GREAT

01. Principal 8' (*Diapason 8'*)
02. Gedackt 8'
03. Flute Celeste II 8' (*Erzahler Celeste II 8'*)
04. Octave 4'
05. Gedackt 4'
06. Superoctave 2'
07. Mixture IV
08. Cromorne 8'
09. Chimes (*Harpsichord*)
10. Tremulant
11. Swell to Great
12. MIDI Great (LP)

PEDAL

01. Principal 16'
02. Subbass 16'
03. Bourdon Doux 16' (SW)
04. Octave 8'
05. Gedackt 8'
06. Choralbass 4'
07. Posaune 16' (*Basson 16'*)
08. Cromorne 4'
09. Great to Pedal
10. Swell to Pedal
11. MIDI Pedal (LP)

SWELL

01. Bourdon Doux 16'
02. Bourdon 8'
03. Gemshorn 8'
04. Gemshorn Celeste II 8'
05. Prestant 4'
06. Copula 4'
07. Nazard 2-2/3'
08. Flute a Bec 2'
09. Tierce 1-3/5'
10. Plein Jeu IV
11. Basson 16' (*Fagot 16'*)
12. Trompette 8'
13. Oboe 8'
14. Tremulant
15. Swell Unison Off
16. MIDI Swell (LP)

GENERAL CONTROLS

(LP) = Lighted Piston

Melody

Bass

Pipes Off (LP)

Ancillary On (LP)

Flute Tremulant II (LP)

Main Off (LP)

Antiphonal On (LP)

All Swells (LP)

COMBINATION ACTION

Generals 1-10, Thumb (LP)

SET and General Cancel (0) (LP)

Tutti (LP)

RODGERS 751 / 790 / 795

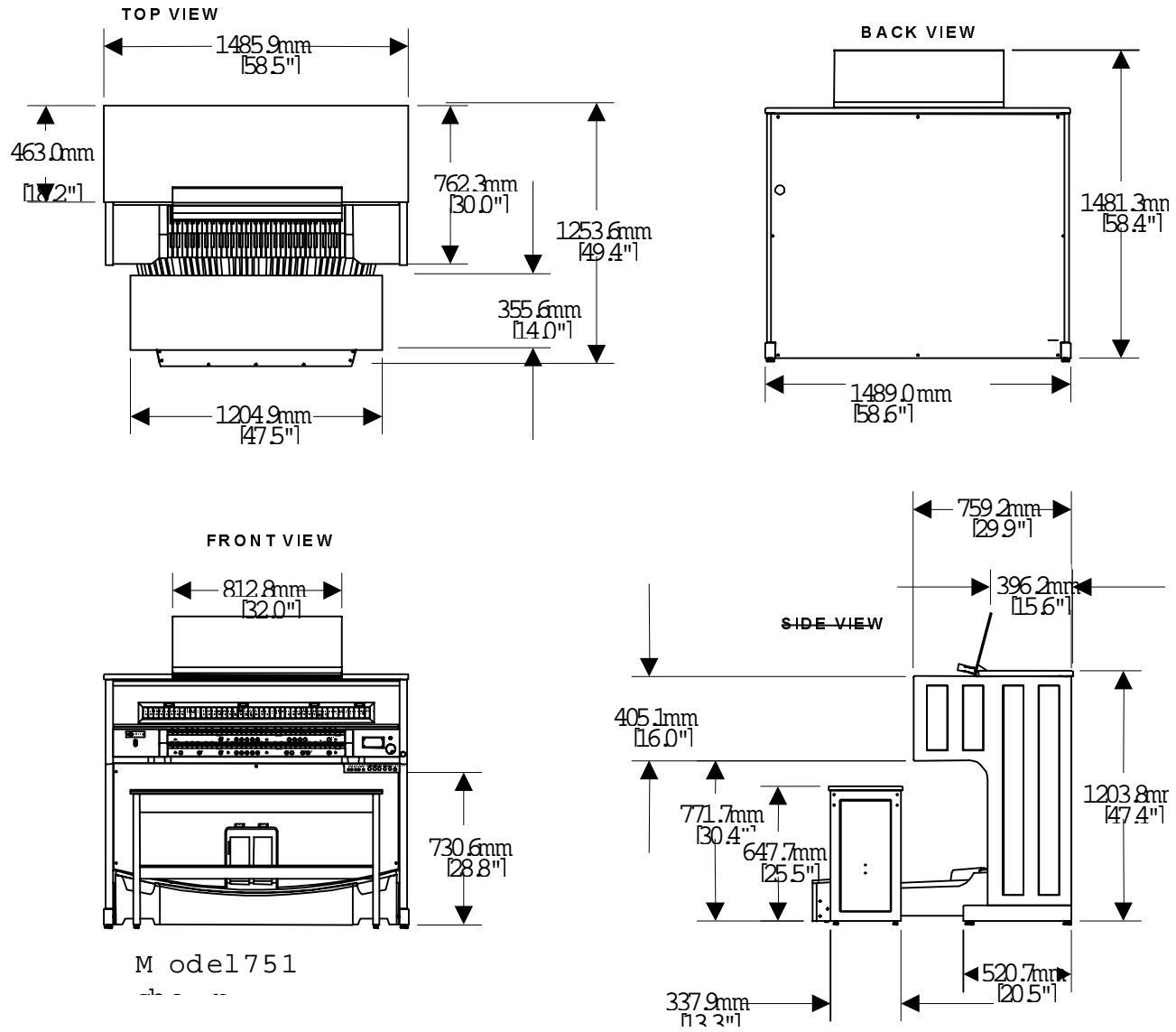

FACTORY DEFAULT COMBINATION SETTINGS

The Rodgers 751 is shipped from the factory with default settings on combination memories 1 and 2. Registrations on M1 and M2 can be changed, but if the original factory default settings are desired, they can be restored by performing the following procedure:

◆ RESTORING THE FACTORY DEFAULT COMBINATION SETTINGS:

1. Press and HOLD the memory select piston (M1, M2, M3 or M4) for approximately five seconds. The display will show “LOCKED” or “UNLOCKED.”

2. While HOLDING the memory piston, press and HOLD the set piston an additional five seconds. The display will read “MEMORY n FACTORY DEFAULT.”

3. Release both pistons. (Note : Each memory must be individually restored by the following procedure above.)

Suggested Registrations

The following pages of registrations are to be used as guidelines for selecting appropriate stops to match broad suggestions given in most printed organ literature. There will be variances of registration depending upon the music, acoustics of the room and the spirit of the performance.

GREAT ORGAN

FLUTE	STRING	SOLO REEDS
Gedackt 8'	Erzahler Celeste II 8' <i>(voice palette)</i>	Cromorne 8'

FOUNDATIONS <i>p</i>	FOUNDATIONS <i>mf</i>	FOUNDATIONS <i>f</i>
Principal 8'	Principal 8' Gedackt 8' Octave 4'	Principal 8' Gedackt 8' Octave 4' Superoctave 2'

PEDAL ORGAN

SOFT BASS	FLUTES	FOUNDATIONS <i>mf</i>
Bourdon Doux 16'	Subbass 16'	Subbass 16' Octave 8'

FOUNDATIONS <i>f</i>	FOUNDATIONS <i>ff</i>	FULL PEDAL
Principal 16' Subbass 16' Octave 8'	Principal 16' Subbass 16' Octave 8' Choralbass 4'	Principal 16' Subbass 16' Octave 8' Choralbass 4' Posaune 16'

SWELL ORGAN

STRING	STRING CELESTE	8' SOLO FLUTES
Gemshorn 8'	Gemshorn Celeste II 8'	Bourdon 8' or Copula 4'

FOUNDATIONS <i>P</i>	FOUNDATIONS <i>mf</i>	FOUNDATIONS <i>f</i>
Bourdon 8' Gemshorn 8'	Bourdon 8' Gemshorn 8' Prestant 4'	Bourdon 8' Gemshorn 8' Prestant 4' Copula 4' Plein Jeu IV

CORNET	SOLO REEDS	FULL SWELL
Bourdon 8' Copula 4' Nazard 2 2/3' Flûte à Bec 2' Tierce 1 3/5' Tremulant optional	Trompette 8' or Oboe 8'	Bourdon Doux 16' Bourdon 8' Gemshorn 8' Octave 4' Plein Jeu IV Basson 16' Trompette 8'

Note: For the instrument's increased versatility, a Unison Off is included in the Swell division. This allows a MIDI sound to be selected and played by itself on the Swell, yet any Swell organ voices that are selected are silent. Those selected Swell organ voices can then be coupled to the Great via the Swell to Great coupler.

**SWELL MANUAL:
PROGRAM CHANGE NUMBERS 62 THROUGH 122**

[REDACTED]	62	63
[REDACTED]	64	
[REDACTED]	66	65
[REDACTED]	67	68
[REDACTED]	69	70
[REDACTED]	71	
[REDACTED]	73	72
[REDACTED]	74	75
[REDACTED]	76	
[REDACTED]	78	77
[REDACTED]	79	80
[REDACTED]	81	82
[REDACTED]	83	
[REDACTED]	85	84
[REDACTED]	86	87
[REDACTED]	88	
[REDACTED]	90	89
[REDACTED]	91	92
[REDACTED]	93	
[REDACTED]	95	94
[REDACTED]	97	96
[REDACTED]	98	99
[REDACTED]	100	
[REDACTED]	102	101
[REDACTED]	103	104
[REDACTED]	105	106
[REDACTED]	107	
[REDACTED]	109	108
[REDACTED]	110	111
[REDACTED]	112	
[REDACTED]	114	113
[REDACTED]	115	116
[REDACTED]	117	118
[REDACTED]	119	
[REDACTED]	121	120
[REDACTED]	122	

CARE AND MAINTENANCE

As with any fine musical instrument, reasonable care is necessary to protect your investment. Normally no difficulties should be experienced, as only the finest component parts are used by Rodgers. If your instrument should require service, your Rodgers Service Representative is fully equipped and qualified to handle any service problems which may arise.

Your new Rodgers organ is not only a fine musical instrument, but also a fine piece of custom-made furniture finished to hold its attractiveness through generations of use. Only the best woods are used, carefully checked for uniformity of grain and intensity of figure and carefully hand assembled. Each finish coat is thoroughly dried before the next coat is applied. A final catalytic process protective coat makes the Rodgers console impermeable to many harmful substances. The resulting finish is lasting and easy to keep looking beautiful. Following are a few tips on caring for your Rodgers organ.

◆ CONSOLE AND PEDALBOARD

A frequent dusting with a soft, clean cloth is usually all that is required. A fine quality furniture oil will enhance the beauty of the wood. Always wipe the surfaces with the grain, using straight, even strokes.

Since extreme cold, heat or exposure to sunlight may injure the finish of any fine piece of furniture, neither the console nor finished speaker cabinets should be placed over a heat register or near a window.

◆ KEYBOARDS AND STOP TABS

Keyboards and tabs should be cleaned with a soft cloth slightly dampened with water and a mild soap. Avoid dripping water between the keys. **DO NOT USE SOLVENTS** (alcohol, gasoline, carbon tetrachloride, etc.).

◆ PIPES ON PIPE-AUGMENTED INSTRUMENTS

To keep the pipes beautiful, refrain from handling them without gloves. The pipes should never be handled or touched by anyone but a qualified organ service representative.

SAFETY INSTRUCTIONS

INSTRUCTIONS PERTAINING TO A RISK OF FIRE, ELECTRIC SHOCK OR INJURY TO PERSONS

IMPORTANT SAFETY INSTRUCTIONS

WARNING: WHEN USING THIS INSTRUMENT, ALWAYS FOLLOW BASIC SAFETY PRECAUTIONS, INCLUDING THE FOLLOWING:

1. Read all the instructions before using, adjusting or repairing this instrument.
2. To reduce the risk of injury, supervise children closely when they are around the instrument.
3. Use this instrument only in the manner recommended by Rodgers Instruments, LLC.
4. Do not use this instrument near water i.e. near a swimming pool or a damp/wet room.
5. Use of this instrument, either alone or in combination with an amplifier and headphones or speakers, may be capable of producing sound levels that could cause permanent hearing loss. **DO NOT** operate for a long period of time at a high volume level or at a level that is uncomfortable. If you experience any hearing loss or ringing in the ears, you should consult an audiologist.
6. Locate the instrument so its position does not interfere with its proper ventilation.
7. Locate the instrument away from heat sources such as radiators, heat registers or other products that radiate heat directly onto the instrument.
8. Protect the instrument from dust as much as possible.
9. Connect the instrument to a power source only of the type described in the operating instructions or as marked on the instrument. Do **NOT** attempt to defeat the grounding connection of the three-prong attachment plug. This is a safety feature. If you are unable to insert the plug into the outlet, contact an electrician to replace your obsolete outlet. Do **NOT** defeat the safety purpose of the plug.
10. Unplug the power cord of the instrument from the power source when left unattended for a long period of time.
11. Do not walk on or place objects on top of the power cord.
12. Do not pull the cord to unplug. Hold the plug when unplugging from the power source.
13. When setting up with other instruments or peripherals, follow the procedures in accordance with Rodgers' owner's manual.
14. Take care that objects do not fall or liquids spill into the instrument.
15. Service the instrument with qualified service personnel when:
 - a. The power cord or plug has been damaged.
 - b. Objects have fallen or liquid has spilled into the instrument.
 - c. The instrument has been exposed to rain or other weather damage.
 - d. The instrument does not appear to operate normally or exhibits a marked change in performance.
 - e. The instrument has been dropped or the enclosure has been damaged.
16. Do not attempt to service the instrument beyond that described in the owner's manual. Refer all other servicing to qualified technical service personnel.

**WARNING: THIS INSTRUMENT MUST BE EARTH GROUNDED.
You must GROUND instruments equipped with a TYPE AC, 3 WIRE GROUNDED PLUG.
SAVE THESE INSTRUCTIONS**

FCC Notice

Radio and Television Interference

Rodgers Parallel Digital Imaging Organs use and generate small amounts of radio-frequency (RF) energy. The instrument complies with the limits set for Class B computing devices. FCC Rules, Part 15, Subpart J define the limits for radio and television interference in a residential installation.

EMC (Electromagnetic Compatibility)

Rodgers Parallel Digital Imaging Organs also comply with the following International EMC Standards:

Radiated Emissions	EN55022 Class B
Conducted Emissions	EN55022 Class B
Voltage Fluctuation	EN61000-3-3
Harmonics	EN61000-3-2
EFT/Burst Immunity	EN50082-1
Radiated Immunity	EN50082-1

Follow the installation and the use instruction in the manual, or the instrument could potentially cause interference with some radio or television reception. In the unlikely event this occurs, we encourage the user to try the following corrective measures:

- ✓ Turn the instrument OFF to see if it is the actual source of the interference.
- ✓ Disconnect the peripheral devices and their input/output cables one at a time. If the interference stops, it is caused by the peripheral device or its I/O cable.
- ✓ Try coiling and uncoiling the instrument's power cord in different ways.
- ✓ Connect the instrument's power cord to a power outlet on a different circuit.
- ✓ Move the instrument further away from the radio or television receiver.
- ✓ Turn the radio or television receiver until the interference stops.
- ✓ Connect the radio or television receiver to a different power circuit.
- ✓ Reorient or move the receiver antenna further away from the instrument. Consider installing a rooftop antenna with coaxial cable lead-in between the antenna and receiver.
- ✓ Consult the nearest Rodgers dealer for more information if the above corrective measures don't remove the interference.



CAUTION
 RISK OF ELECTRIC
 SHOCK
 DO NOT OPEN



WARNING
 TO REDUCE THE RISK OF
 FIRE OR ELECTRIC
 SHOCK, DO NOT EXPOSE
 THIS APPLIANCE TO RAIN
 OR MOISTURE.

PATENTS
 G.B. 1312161
 F.R.G. 22 02 658
 CANADIAN 951550
 (1994)

ATTENTION: RISQUE OF CHOC ELECTRIQUE NE PAS OUVRIR

**CAUTION: TO REDUCE THE RISK OF
 ELECTRICAL SHOCK:**
DO NOT REMOVE COVER OR BACK.
NO USER-SERVICABLE PARTS INSIDE.
**REFER SERVICING TO QUALIFIED SERVICE
 PERSONNEL.**

The lightning flash with arrowhead symbol, within an equilateral triangle, is intended to alert the user to the presence of uninsulated "dangerous voltage" with the product's enclosure that may be of sufficient magnitude to constitute a risk of electrical shock to persons.

The exclamation point within the equilateral triangle is intended to alert the user to the presence of important operating instructions in the literature accompanying the product.

Notice to Users

Information in this document is subject to change without notice. No part of this manual may be translated into any language, stored in a retrieval system, reproduced or transmitted in any form or by any means, electronic or mechanical, including photocopying and recording, for any purpose without the express written permission of **Rodgers Instruments, LLC.**

RODGERS INSTRUMENTS, LLC
 1300 N.E. 25th Avenue
 Hillsboro, Oregon 97124
 (503) 648-4181

RODGERS IN CANADA
 5480 Parkwood Way
 Richmond, B.C. V6V 2M4
 (604) 270-6332

©Copyright 1998, Rodgers Instruments, LLC, a member of the Roland Group. All rights reserved. Printed in the United States of America, September 1998. Rodgers®, Rodgers Classic Organs®, Parallel Digital Imaging®, Voice Palette™, DVM™ and PDI™ are trademarks of Rodgers Instruments, LLC, Hillsboro, Oregon

Function		Transmitted	Recognized	Remarks
Basic	Default:	1-4, 6, 7, 11-16 *1	11-16 *1	12=Gt 13=Sw 14=Ped 15=Ch 16=Solo 11=Fest Trpt MIDI GT A only
Channel	Changed:	1-16		
Mode	Default: Messages: Altered:	Mode 3 X *****	Mode 3 X *****	
Note Number	True Voice	8-124	36-96	
Velocity	Note On: Note Off:	O O	X X	
After Touch	Keys: Channel:	X X	X X	
Pitch Bender		X	X	
Control Change	0	O	X	GS Bank Select
	7	O	O	Div Expression on each Master Channel (11-16 as listed above)
	64	O	X	MIDI GT A Channel
Program Change	True #	1-128 *****	(1-12, 20-26) *****	Ch. 12-16 only; activates comb. pistons
System Exclusive		O *2	O *2	
System Common	:Song Pos :Song Sel :Tune	X X X	X X X	
System Real Time	:Clock :Commands	X X	X O *3	
Aux Messages	:Local ON/OFF :All Notes Off :Active Sense :Reset	X O (123) O X	X O (123) O X	
Notes:	*1 *2 *3	Able to choose between O and X. SysEx used for stop changes, combination memory dumps. Received Start sends current stop and expression status. Received Stop restores expression to shoe positions. Received Continue sets expression to values at last Stop.		

Mode 1: OMNI ON, POLY
Mode 3: OMNI OFF, POLY

Mode 2: OMNI ON, MONO
Mode 4: OMNI OFF, MONO

O : Yes
X : No



1300 N.E. 25TH AVENUE, HILLSBORO, OREGON 97124 • (503) 648-4181

1905-791E